

# High Quality Dental Instruments



**NAZEERIYA  
HAROOONIYA**  
Surgical Industries



✉ info@nhsurgical.com

☎ Owner: Ali Imran

🌐 Website: www.nhsurgical.com

📍 Address: Chowk Duburgi Mallian  
Madni Market Daska Road Sialkot



**01**



**EXTRACTING FORCEPS**

**Page # 01 - 14**

**02**



**ROOT ELEVATORS**

**Page # 15 - 29**

**03**



**DIAGNOSTIC, PROBES, SCALERS, FILLING  
& LABORATORY INSTRUMENTS**

**Page # 30 - 77**

**04**



**MAXILLOFACIAL SURGERY  
INSTRUMENTS**

**Page # 78 - 95**

**05**



**ORTHODONTIC INSTRUMENTS  
& PLIERS**

**Page # 96 - 107**

**06**



**DENTAL IMPLANT INSTRUMENTS**

**Page # 108 - 142**

**07**

**impression Tray & Hollow wares**

**Page # 143 - 148**

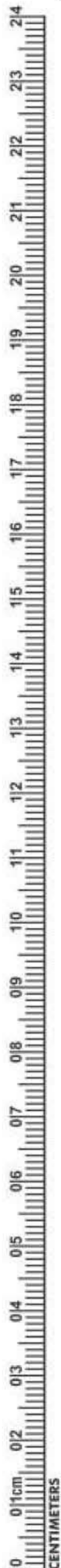

CENTIMETERS



# EXTRACTING FORCEPS

**HANDLE GRIP AVAILABLE  
A, B, C, D**

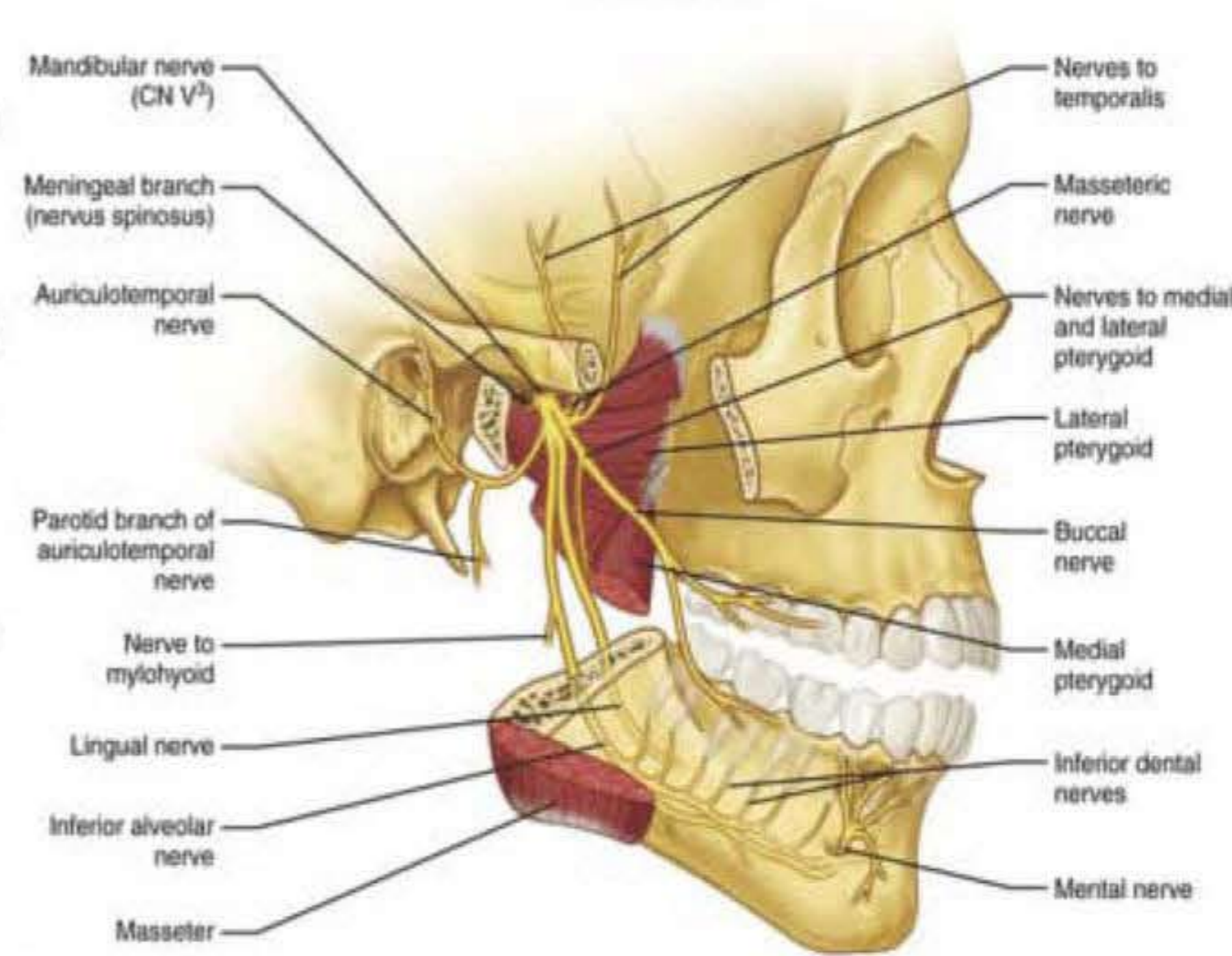
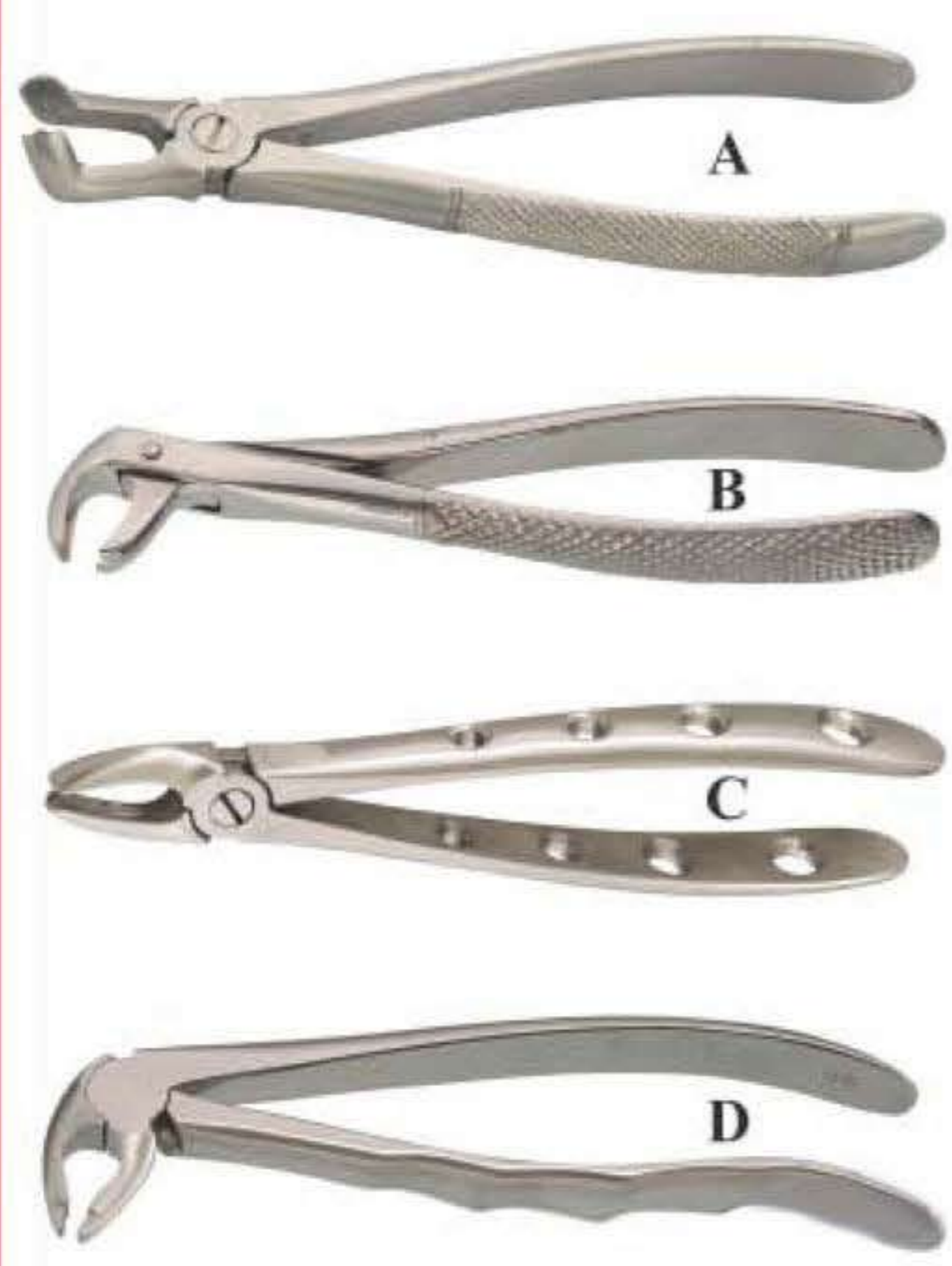

## EXTRACTING FORCEPS (English Pattern)

- Щипцы экстракционные (английская форма)
- Щипці екстракційні (англійська форма)
- Forceps de Extracción (Forme Inglesa)
- استخراج المنقط (نمط اللغة الإنجليزية)
- Daviers (Forme Anglaise)
- Zahnzangen (Englische Form)



**NHS-001**  
Fig. 23  
Syndesmotome lower roots



**NHS-002**  
Fig. 24  
Syndesmotome upper molar



**NHS-003**  
Fig. 25  
Syndesmotome Lower molar forceps



**NHS-004**  
Fig. 79  
Lower Wisdoms



**NHS-005**  
Fig. 60  
Upper roots, extra slim jaws



**NHS-006**  
Fig. 62  
Upper roots, extra slim jaws



**NHS-007**  
Fig. 74  
Upper roots and incisors



**NHS-008**  
Fig. 33  
Lower Roots



**NHS-009**  
Fig. 51  
Upper Roots



**NHS-010**  
Fig. 61  
upper Roots, short,  
extra slim jaws



**NHS-011**  
Fig. 67  
upper wisdoms,  
either sides



**NHS-012**  
Fig. 86  
lower molars decayed or  
with broken down crown

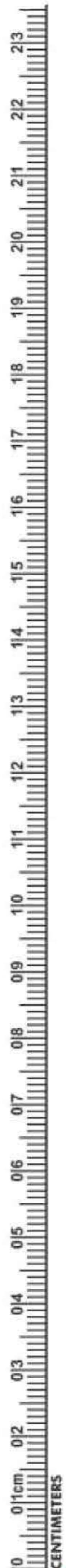
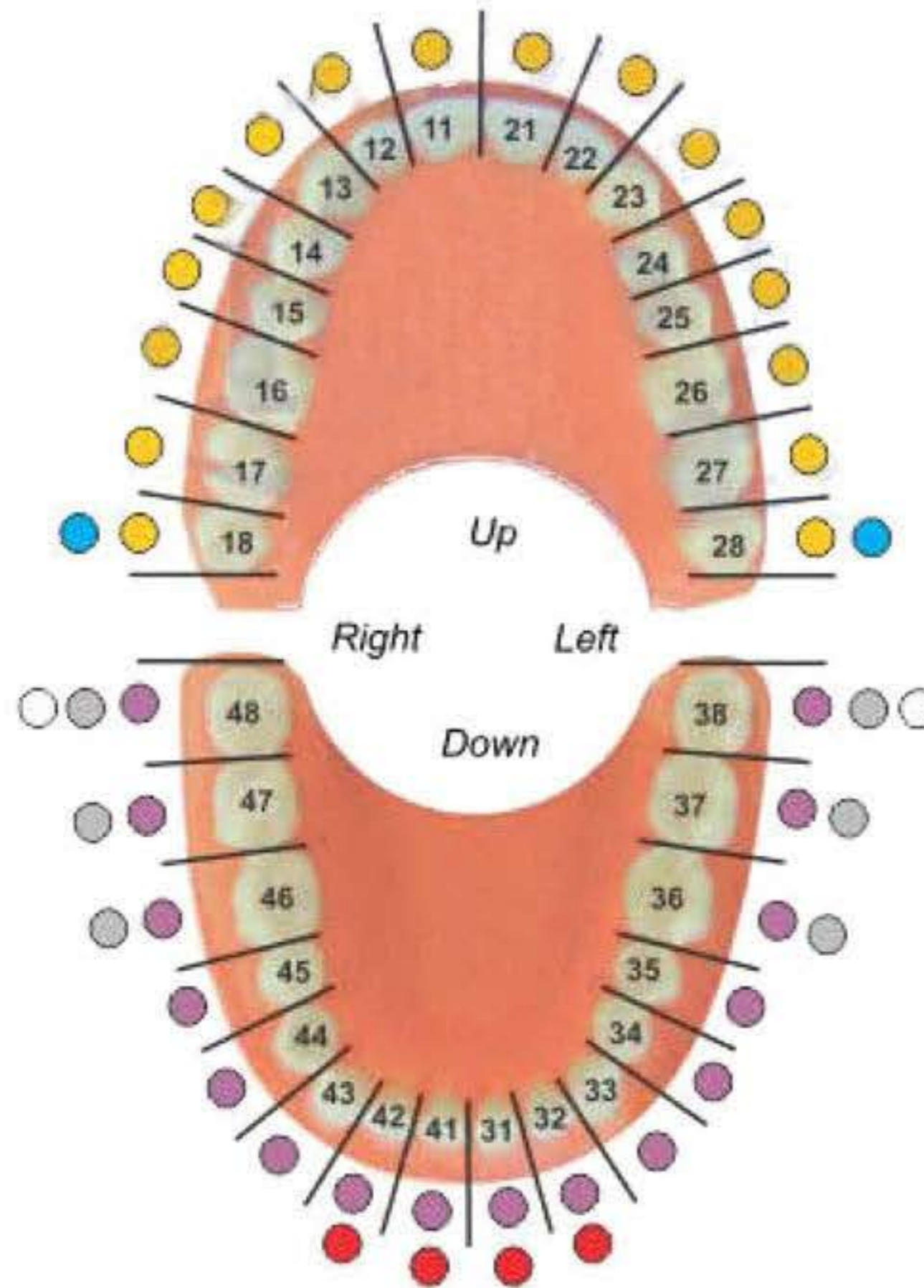



## EXTRACTING FORCEPS (English Pattern)

- Щипцы экстракционные (английская форма)
- Daviers (Forme Anglaise)
- Zahnzangen (Englische Form)

- Щипці екстракційні (англійська форма)
- Forceps de Extracció (Forme Inglesa)
- استخراج الملقط (نمط اللغة الإنجليزية)



NHS-013  
Fig. 01  
upper centrals and canines



NHS-014  
Fig. 04  
Lower incisors and Canines



NHS-015  
Fig. 08  
Lower Bicuspid



NHS-016  
Fig. 17  
Upper right molars



NHS-017  
Fig. 73  
Lower molars



NHS-018  
Fig. 21  
Lower molars



NHS-019  
Fig. 02  
upper incisors and canines



NHS-020  
Fig. 07  
Lower Canines and bicuspid



Lower Canines and bicuspid



NHS-022  
Fig. 18  
Upper Left Molars



NHS-023  
Fig. 22  
Lower molars - Untere Molaren



NHS-024  
Fig. 75  
Lower canines and bicuspid

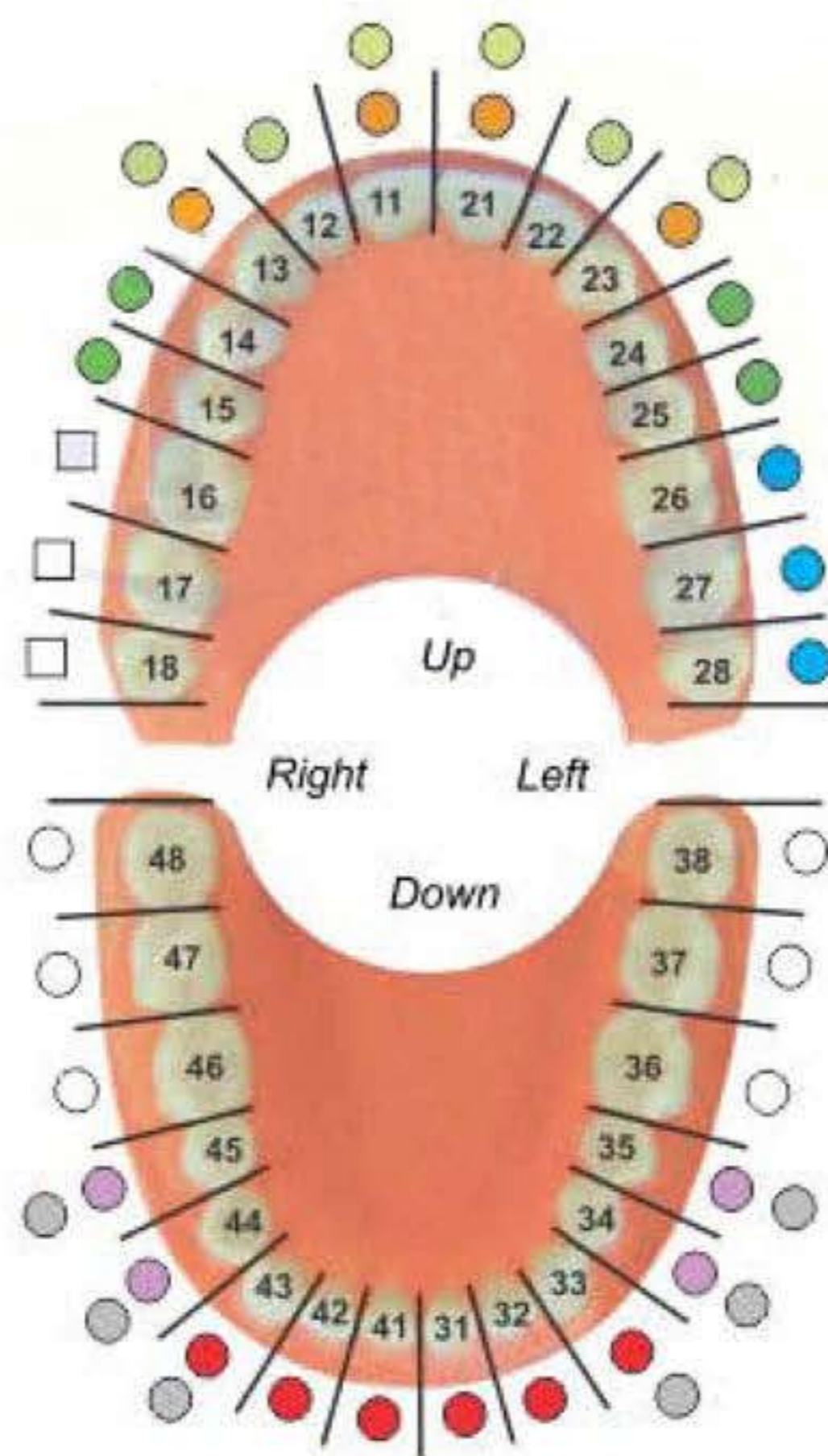





**NAZEERIYA  
HAROONIYA**  
Surgical Industries

## EXTRACTING FORCEPS (English Pattern)

- Щипцы экстракционные (английская форма)
- Daviers (Forme Anglaise)
- Zahnzangen (Englische Form)

- Щипці екстракційні (англійська форма)
- Forceps de Extracción (Forme Inglesa)
- استخراج الملقط (نمط اللغة الإنجليزية)

### Apical Set of 9 Pcs (Deep Gripe Extracting Forceps)



- No Fracture
- No Tissue Damage
- Extraction With Easy

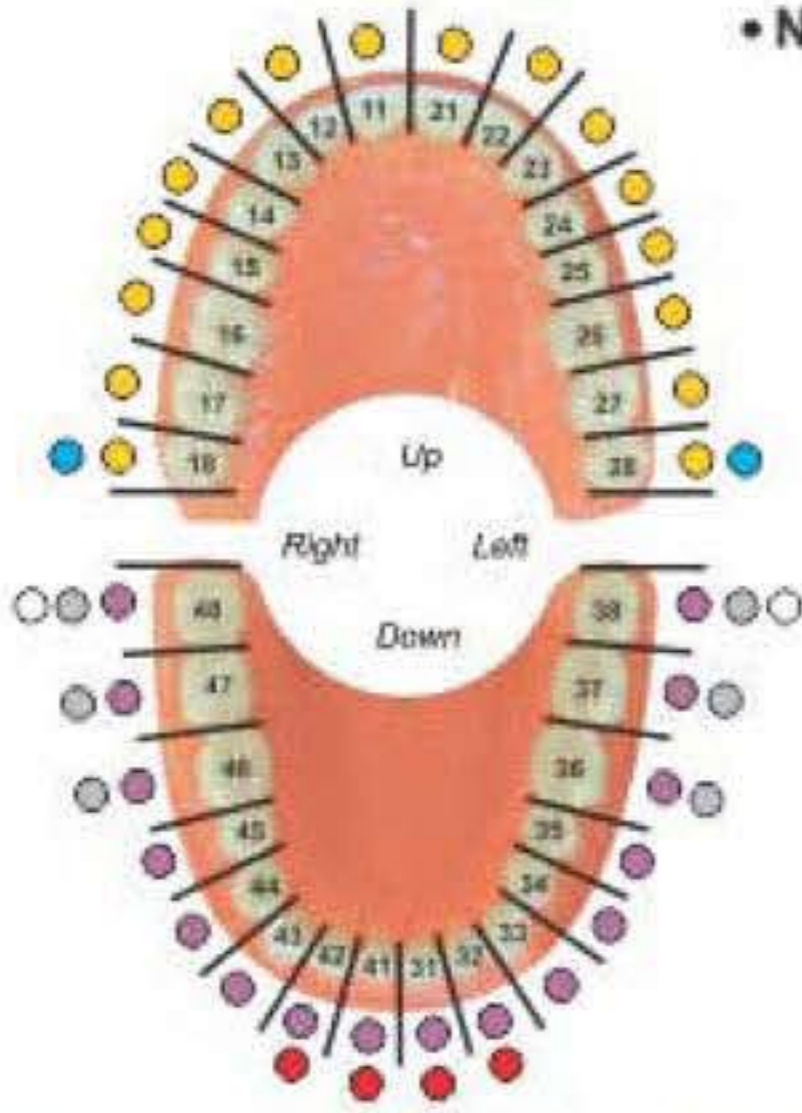

NHS-029

F-2

LOWER UNIVERSAL

Wide Tip

NHS-030

F-4

LOWER ANTERIOR

Thin Tip

NHS-025

F-1

UPPER UNIVERSAL

Wide Tip

NHS-026

F-1

UPPER UNIVERSAL

Thin Tip

NHS-027

F-3

UPPER ANTERIOR

Wide Tip

NHS-028

F-3

UPPER ANTERIOR

NHS-031

F-4

LOWER ANTERIOR

NHS-032

F-6

UPPER 3RD

NHS-033

F-7C

LOWER MOLAR

### A-TRAUMATIC EXTRACTION SET

Improved tapered beaks for complete root contact. Cross serrations for a never slip grasp. Easily enter the sub gingival.



## EXTRACTING FORCEPS (English Pattern)

- Щипцы экстракционные (английская форма)
- Daviers (Forme Anglaise)
- Zahnzangen (Englische Form)
- Щипці екстракційні (англійська форма)
- Forceps de Extracción (Forme Inglesa)
- استخراج المنقط (نمط اللغة الإنجليزية)



Fig. 79A



Fig. 45Z



Fig. 51Z



Fig. 44Z



Fig. 46



Fig. 67



Fig. 67A



Fig. 79



**NHS-034**  
Fig. 9  
Apex Forceps Lower Universal  
Deep Root Pick



**NHS-035**  
Fig. 187  
Apex Forceps Lower Root  
Deep Root Pick



**NHS-036**  
Fig. 189  
Apex Forceps  
Upper Root  
Deep Root Pick



**NHS-037**  
Fig. 190  
Apex Forceps Upper Root  
Deep Root Pick



**NHS-038**  
Fig. 46XL  
Apex Forceps Lower Root  
Deep Root Pick

### DEEP ROOT PICK FORCEPS (Apical Set of 9)

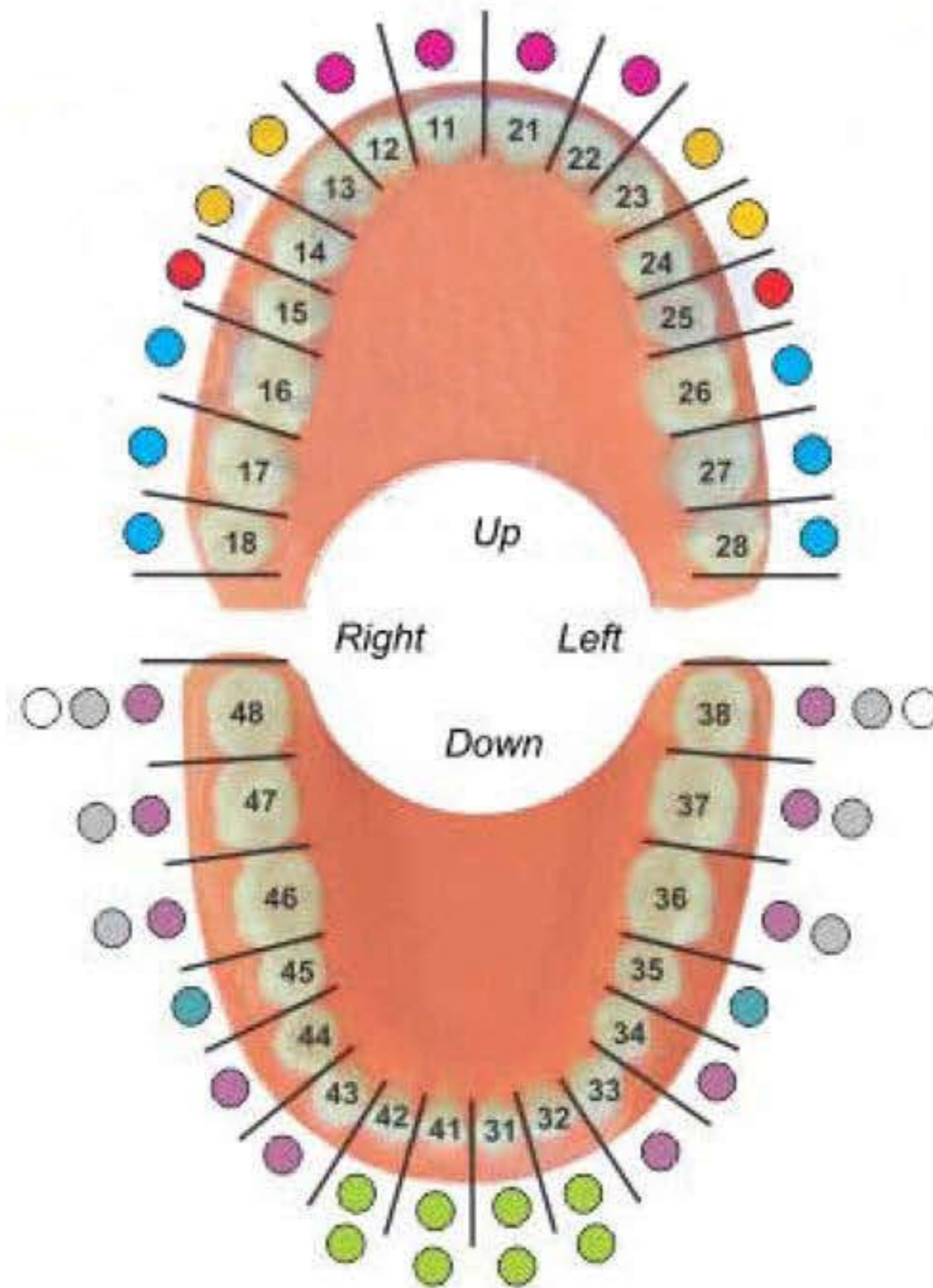

**NHS-039**  
Fig. 67  
Upper Thrid Molars

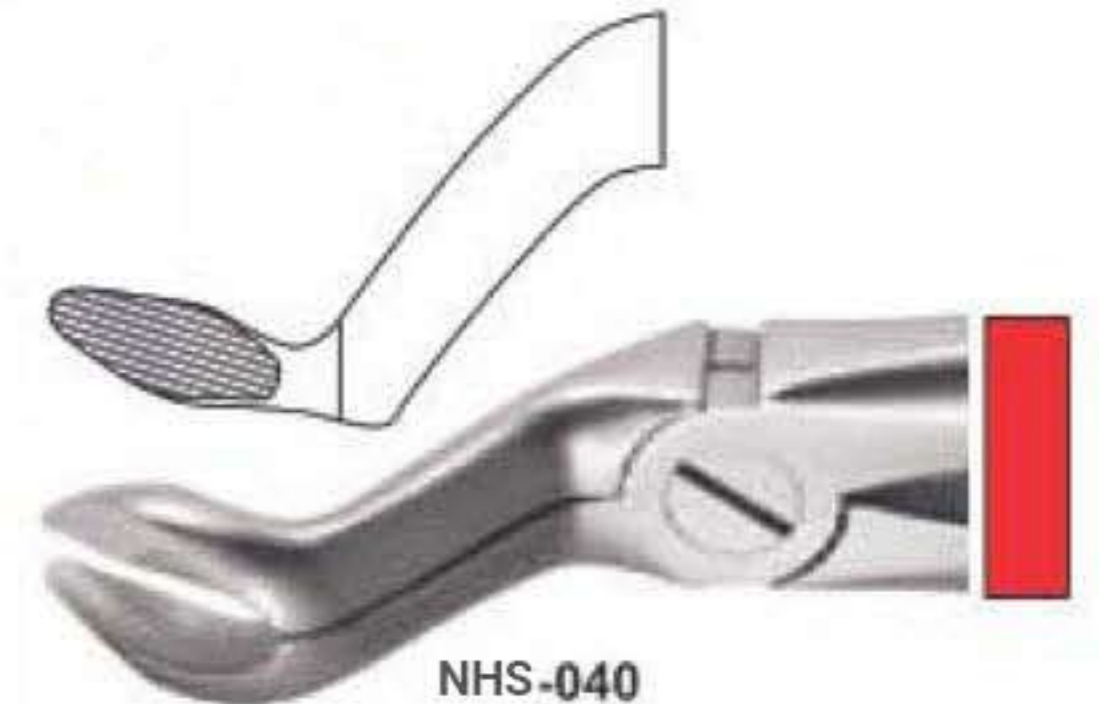

**NHS-040**  
Fig. 67A  
Upper Thrid Molars



**NHS-041**  
Fig. 79  
Lower Thrid Molars



**NHS-042**  
Fig. 37  
Lower Root Molars





# EXTRACTING FORCEPS (English Pattern)

- Щипцы экстракционные (английская форма)
- Daviers (Forme Anglaise)
- Zahnzangen (Englische Form)
- Щипці екстракційні (англійська форма)
- Forceps de Extracción (Forme Inglesa)
- استخراج الملقط (نمط اللغة الإنجليزية)

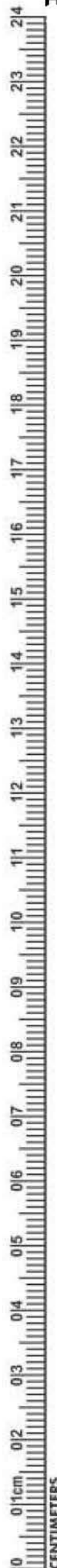

NHS-043 Fig. 2 upper laterals and canines



NHS-044 Fig. 7 Upper Premolars/Bicuspid



NHS-045 Fig. 17 Upper Molars, Right



NHS-046 Fig. 18 Upper Molars, Left



NHS-047 Fig. 67 upper third molars

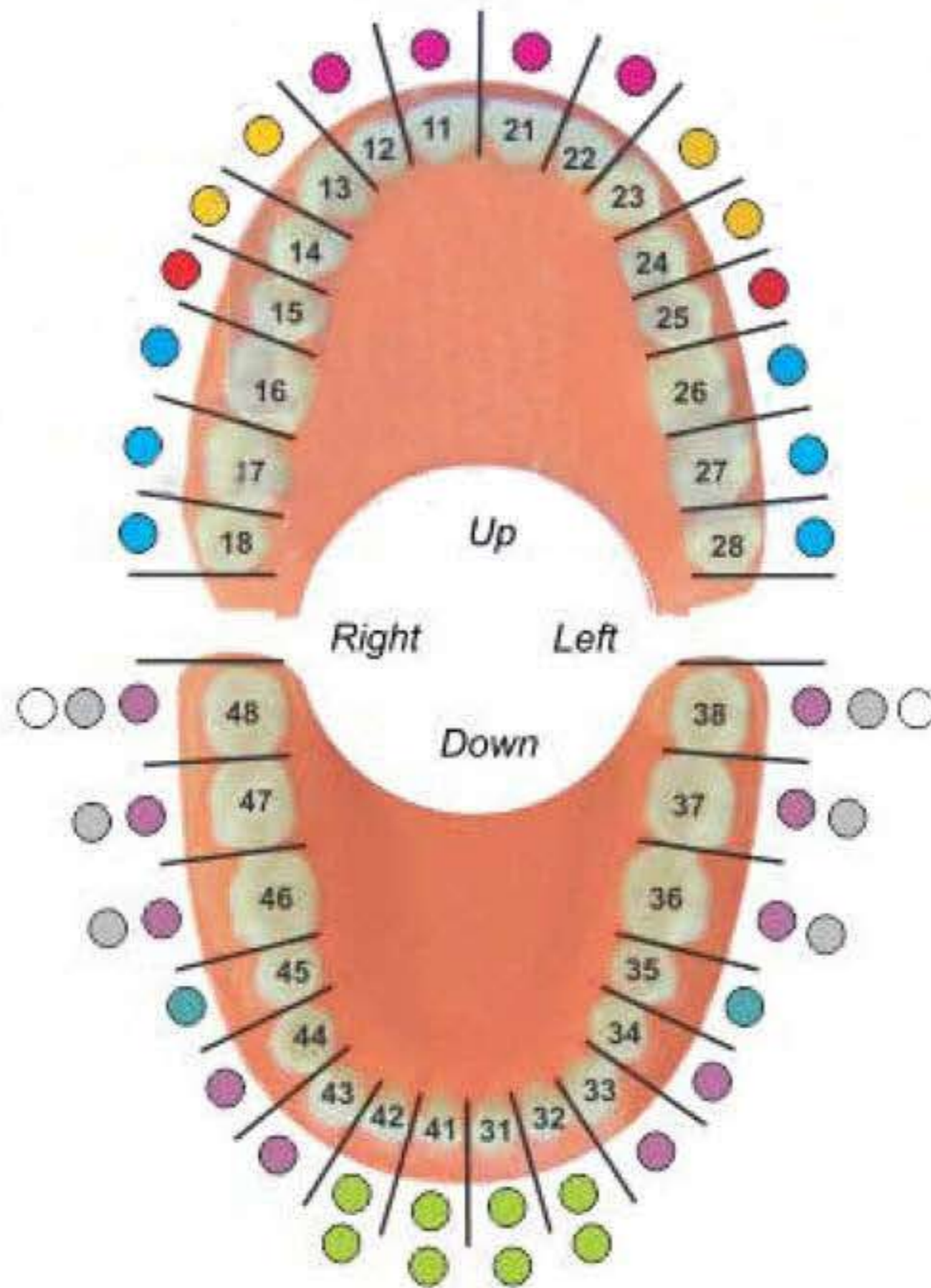

NHS-048 Fig. 13 Lower Premolars/Bicuspid



NHS-049 Fig. 22 Lower Molars

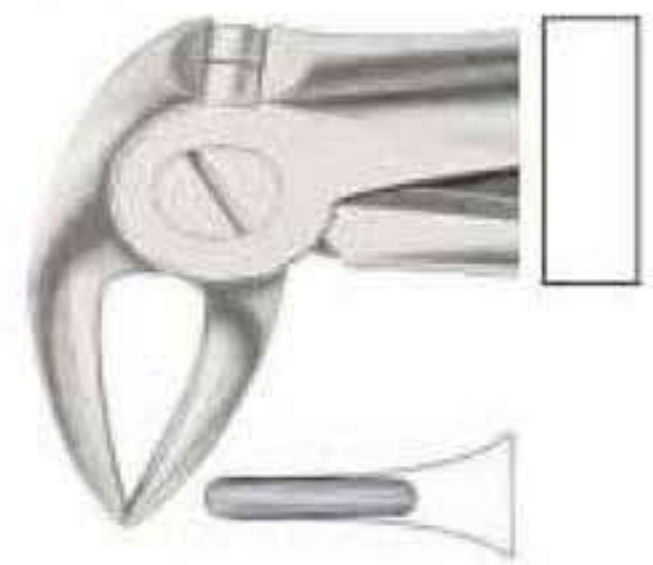

NHS-050 Fig. 33 lower roots



NHS-051 Fig. 51 upper roots



NHS-052 Fig. 79 Lower third molars



## EXTRACTING FORCEPS (English Pattern)

- Щипцы экстракционные (английская форма)
- Daviers (Forme Anglaise)
- Zahnzangen (Englische Form)
- Щипці екстракційні (англійська форма)
- Forceps de Extracción (Forme Inglesa)
- استخراج الملقط (تمط اللغة الإنجليزية)



**NHS-053**  
**Fig. 1**  
upper laterals  
and canines



Extracting Forceps  
Set of 10 Pcs  
Detail of Pack  
Forceps  
Fig. 1  
Fig. 2  
Fig. 73  
Fig. 67  
Fig. 51A  
Fig. 74  
Fig. 51  
Fig. 7  
Fig. 13



**NHS-054**  
**# 2**  
upper laterals  
and canines



**NHS-058**  
**# 74**  
lower roots



**NHS-059**  
**# 51**  
upper roots



**NHS-055**  
**# 73**  
lower molars

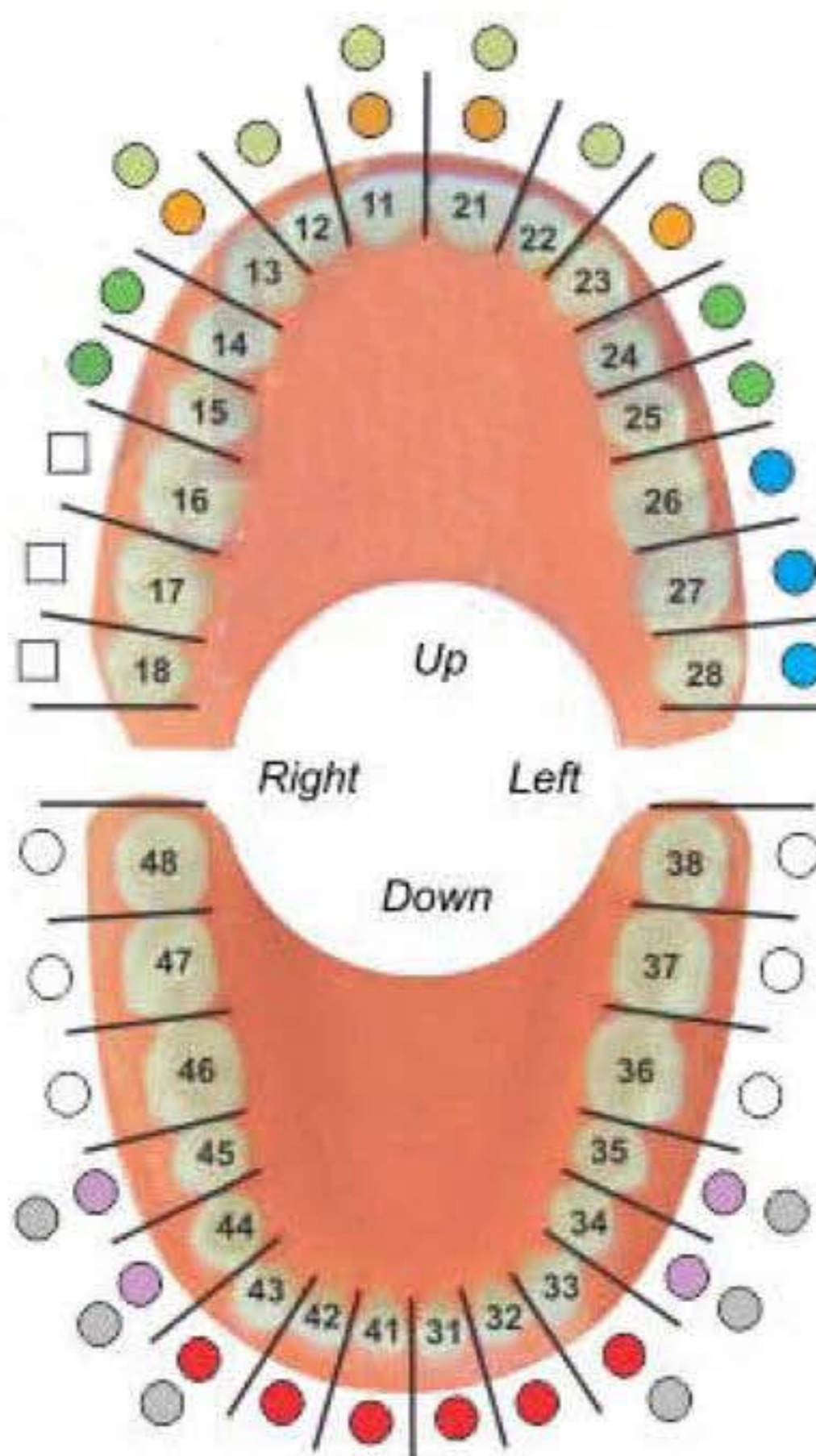

**NHS-060**  
**# 17**  
upper molars,  
right



**NHS-056**  
**# 67**  
upper third  
molars

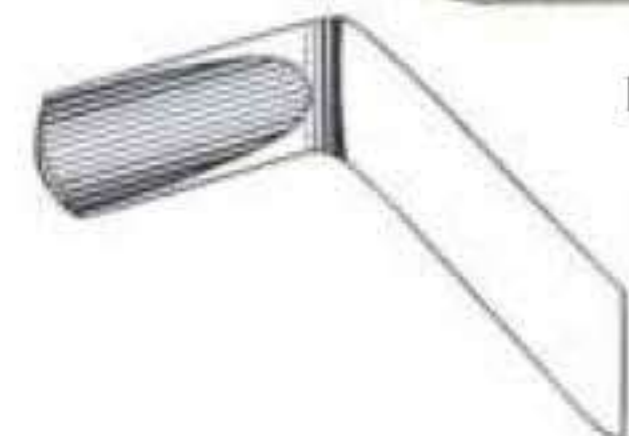

**NHS-061**  
**# 7**  
upper premolars



**NHS-057**  
**# 51 A**  
upper roots



**NHS-062**  
**# 13**  
lower premolars







## EXTRACTING FORCEPS (English Pattern)

- Щипцы экстракционные (английская форма)
- Daviers (Forme Anglaise)
- Zahnzangen (Englische Form)

- Щипці екстракційні (англійська форма)
- Forceps de Extracción (Forme Inglesa)
- استخراج الملقط (نمط اللغة الإنجليزية)

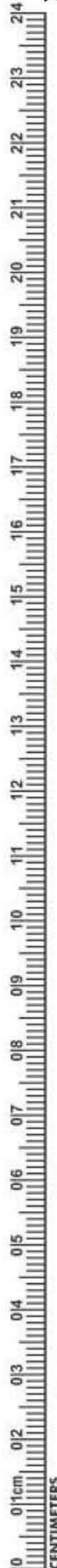

Set of 10 Pieces  
 Fig. 1  
 Fig. 7  
 Fig. 13  
 Fig. 17  
 Fig. 18  
 Fig. 22  
 Fig. 33A  
 Fig. 51A  
 Fig. 67A  
 Fig. 79



**NHS-063**  
 Fig. 1  
 Upper Centrals  
 & Canines/Cuspids



**NHS-068**  
 Fig. 22  
 Lower Molars



**NHS-064**  
 Fig. 7  
 Upper Premolars/  
 Bicuspid



**NHS-069**  
 Fig. 33A  
 Lower Roots  
 Narrow tips



**NHS-065**  
 Fig. 13  
 Lower Premolars/  
 Bicuspid

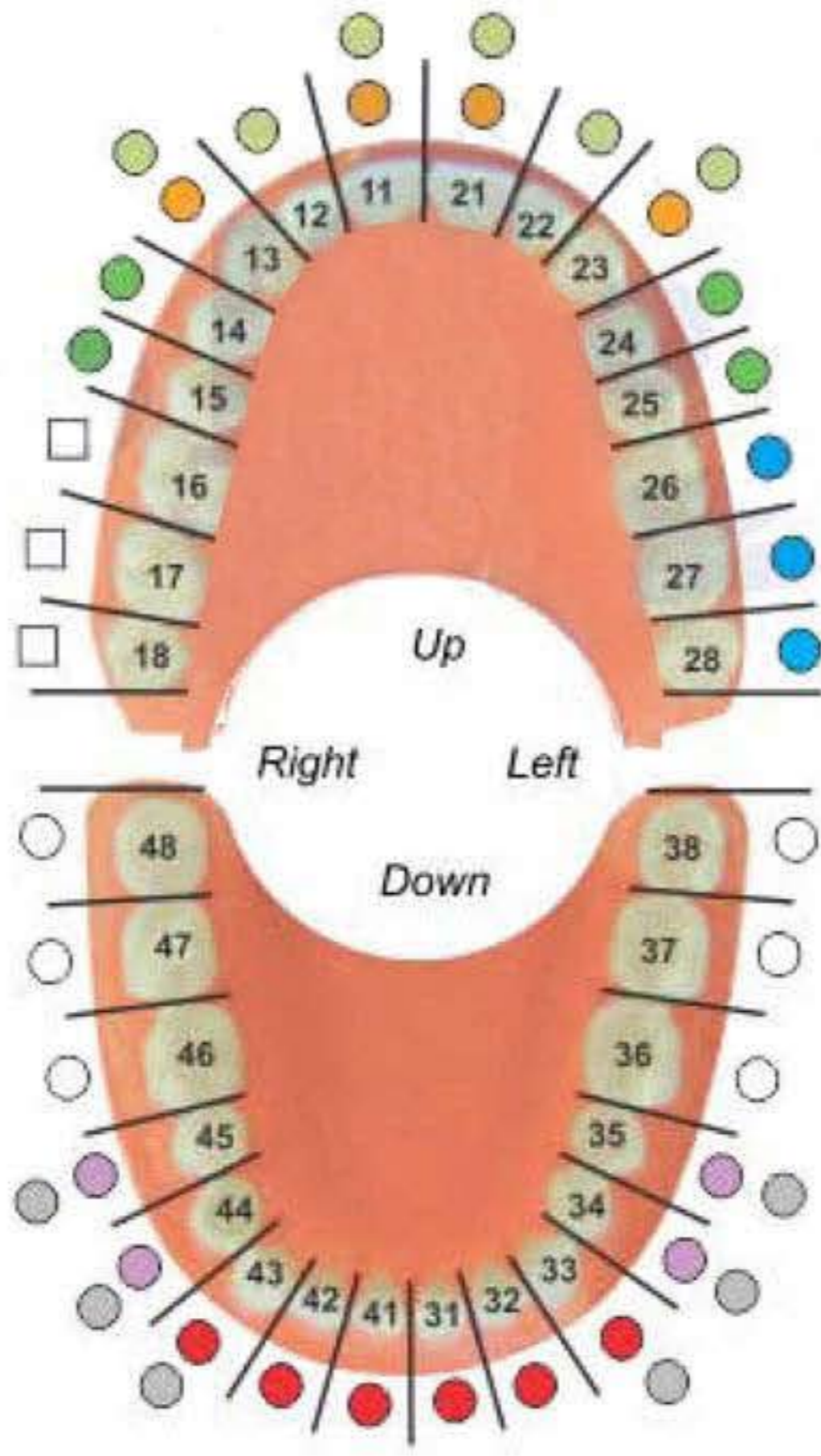

**NHS-070**  
 Fig. 51A  
 Upper roots  
 narrow tips



**NHS-066**  
 Fig. 17  
 Upper Molars,  
 Right



**NHS-071**  
 Fig. 67A  
 Upper third  
 molars



**NHS-067**  
 Fig. 18  
 Upper Molars,  
 Left



**NHS-072**  
 Fig. 79  
 Lower third  
 molars



# EXTRACTING FORCEPS

- Щипцы экстракционные
  - Daviers
  - Zahnzangen
- Щипці екстракційні
  - Forceps de Extracció
  - استخراج العنق

## Pediatric Tooth Extracting Forceps Set

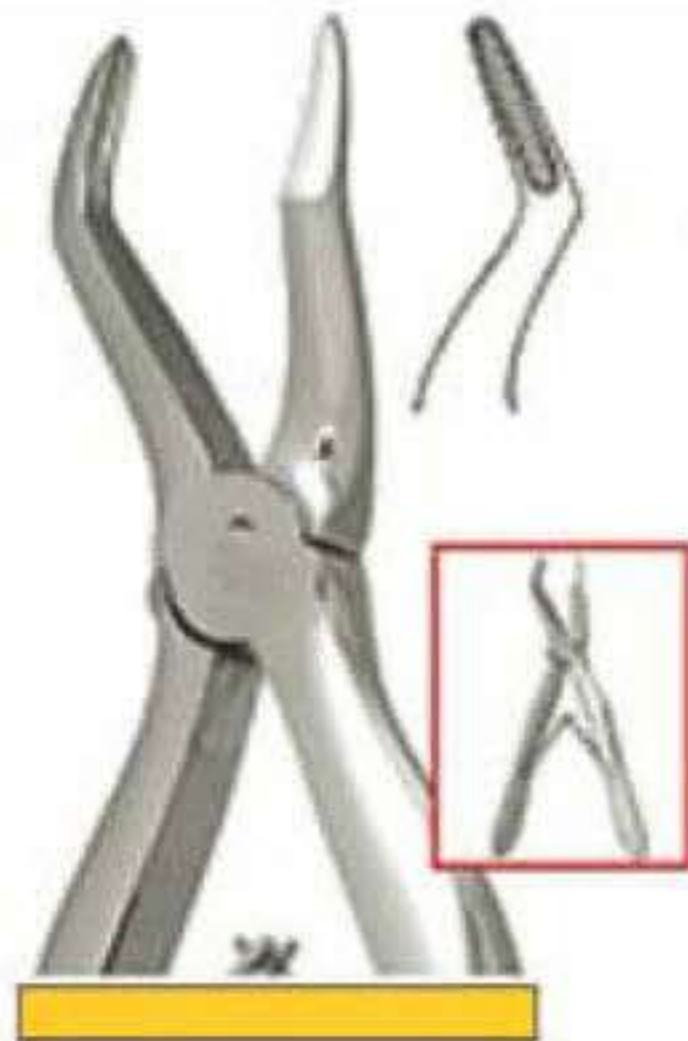

**NHS-074**  
English Pattern Klein #51S  
Pedodontic Upper root



**NHSI-073**  
English Pattern Klein #137  
Pedodontic, Upper Incisors  
Spring handle



**NHS-077**  
English Pattern Klein #5  
Pedodontic Lower Incisors.



**NHS-075**  
English Pattern Klein #139  
Pedodontic Upper Premolars



Fig. # 01 to 07  
Set of 7 Pieces



**NHS-078**  
English Pattern Klein #7  
Pedodontic Lower Roots,



**NHS-076**  
English Pattern Klein #3  
Pedodontic Upper Molars  
Universal

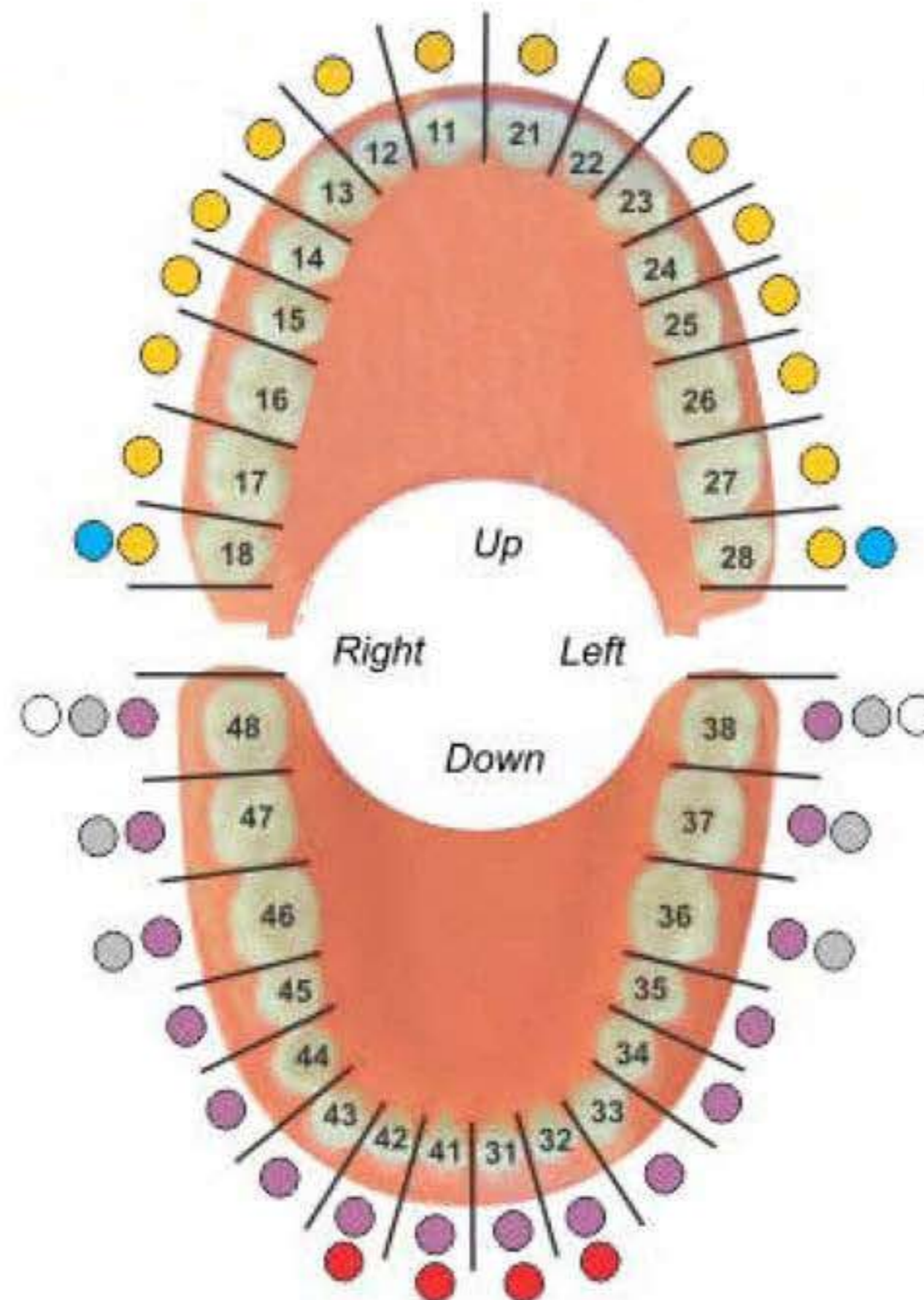

**NHS-079**  
English Pattern Klein #6  
Pedodontic Lower Molars,  
Spring Handle







# EXTRACTING FORCEPS

- Щипцы экстракционные
- Daviers
- Zahnzangen
- Щипці екстракційні
- Forceps de Extracción
- استخراج الملقط

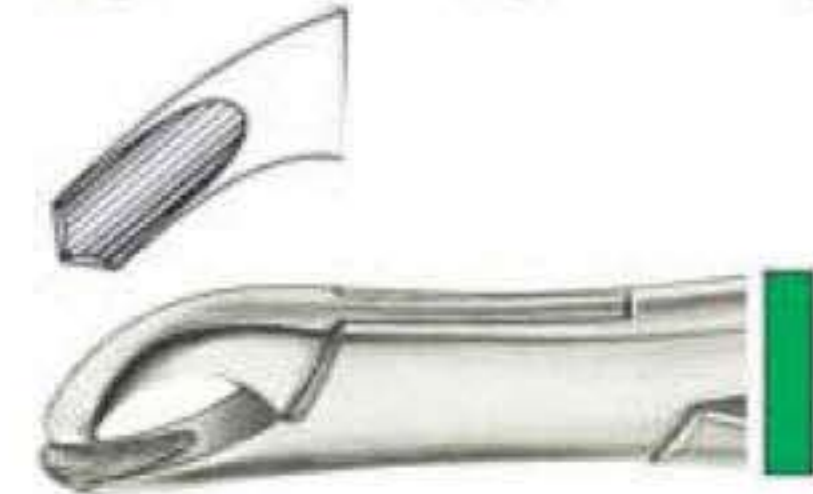
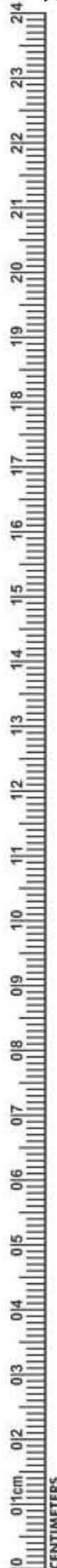

NHS-080  
Fig. 17 SK  
Lower molars

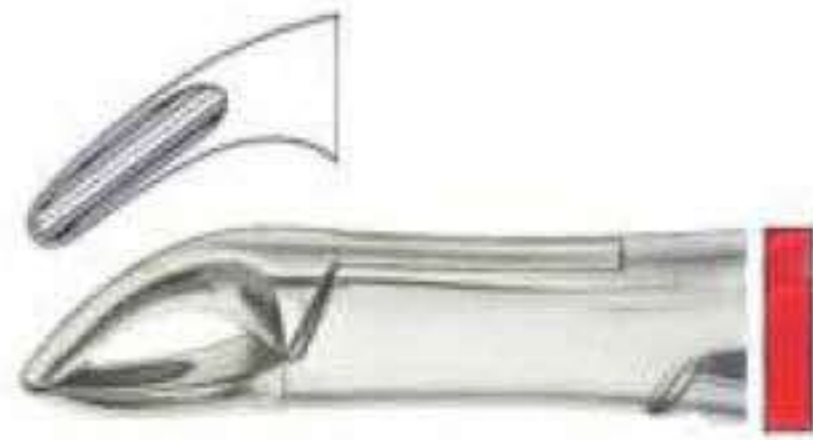

NHS-081  
Fig. 150 SK  
Upper anteriors and roots

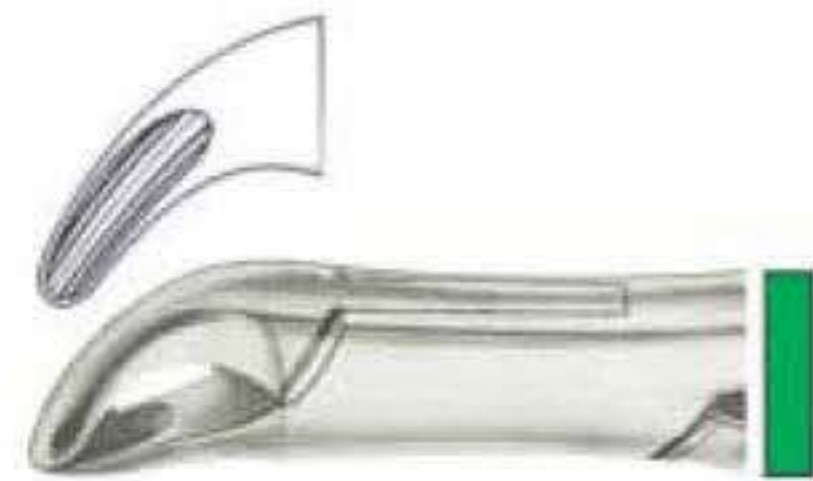

NHS-082  
Fig. 151 SK  
lower anteriors and roots

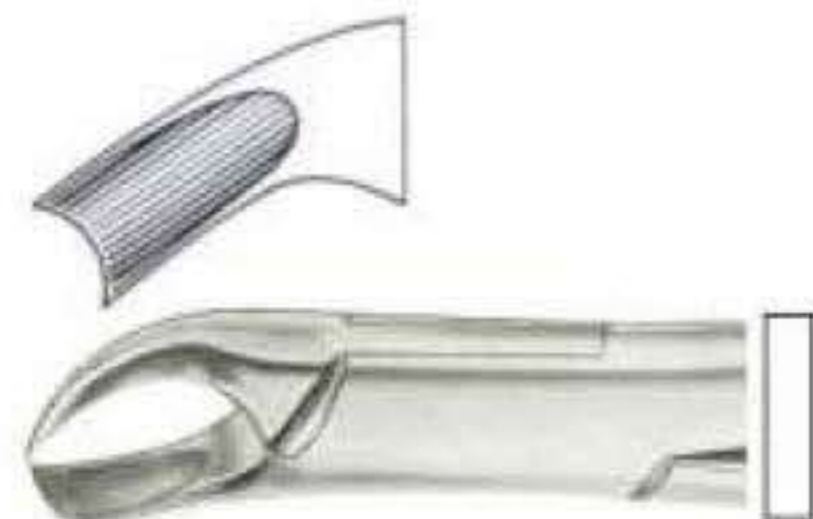

NHS-083  
Fig. 90  
Upper molars, left



NHS-084  
Fig. 17S  
Lower, molars



NHS-085  
Fig. 18LS  
upper, molars left



NHS-086  
Fig. 18RS  
upper, molars right



NHS-087  
Fig. 65S  
upper incisors and roots



NHS-088  
Fig. 69S  
upper and lower roots

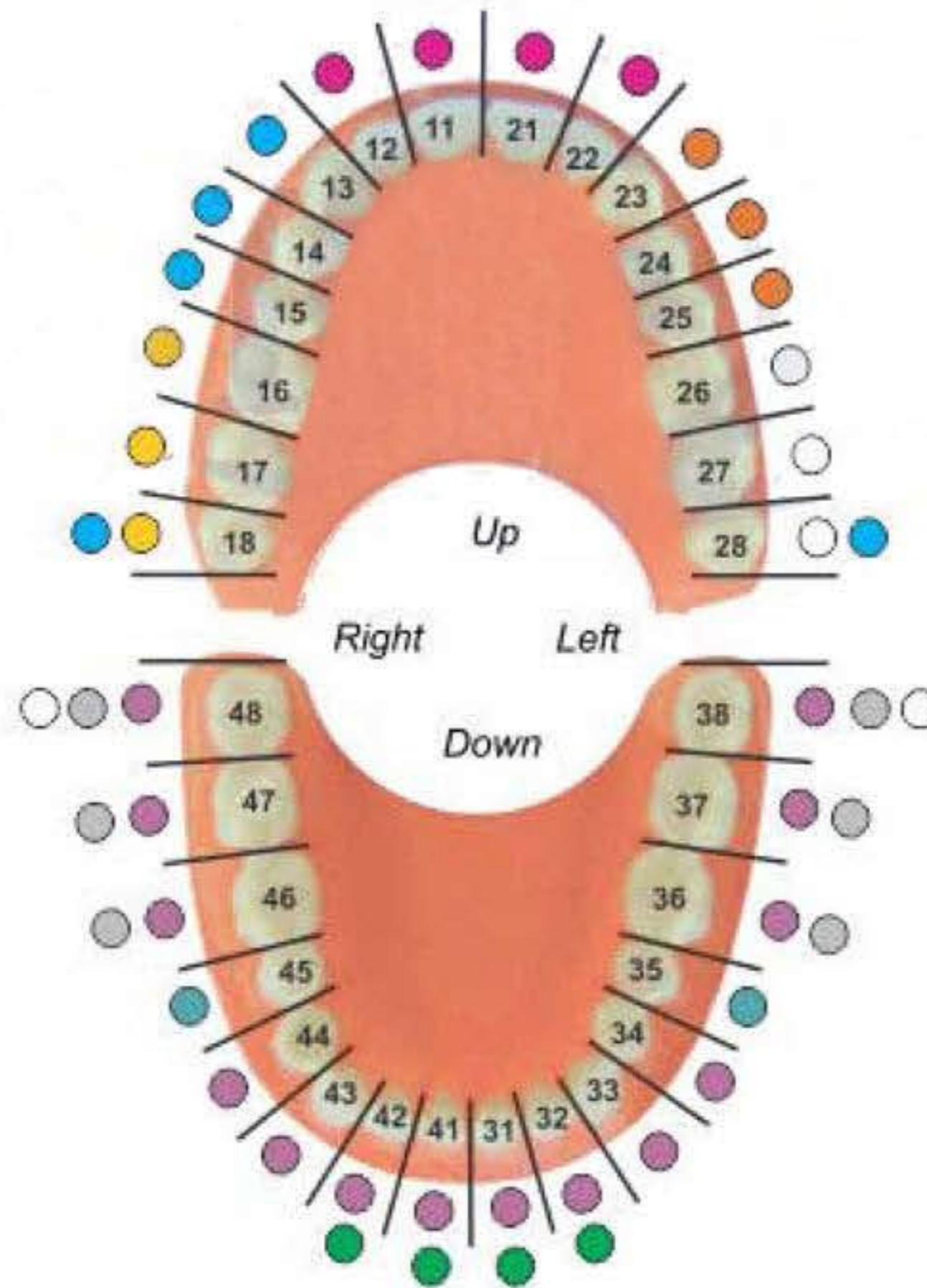



# EXTRACTING FORCEPS (American Pattern)

- Щипцы экстракционные (американская форма)
- Daviers - forme américaine
- Fórceps de extracción - forma americana
- Щипці екстракційні (американська форма)
- Pinzere per estrazione - forma americana
- استخراج الملقط (النمط الأمريكي)



Fig. 150



Fig. 150A



Fig. 150S



Fig. 151A



Fig. 151S



Fig. 151



Fig. 286



Cohen



Fig. 89



Fig. 23S



**NHS-089**  
**# 150**  
Cryer upper incisors, premolars, roots

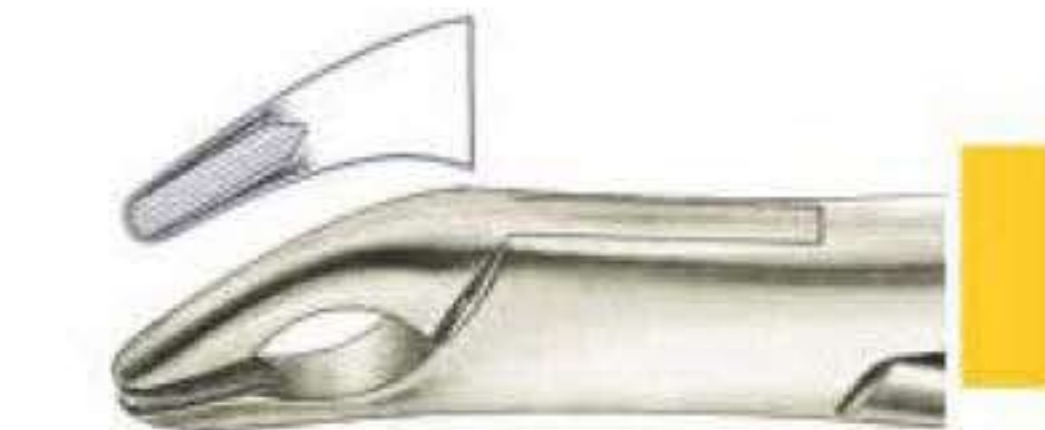

**NHS-090**  
**# 150A**  
Cryer upper incisors, premolars, roots



**NHS-091**  
**# 150S**  
Cryer upper teeth, for children

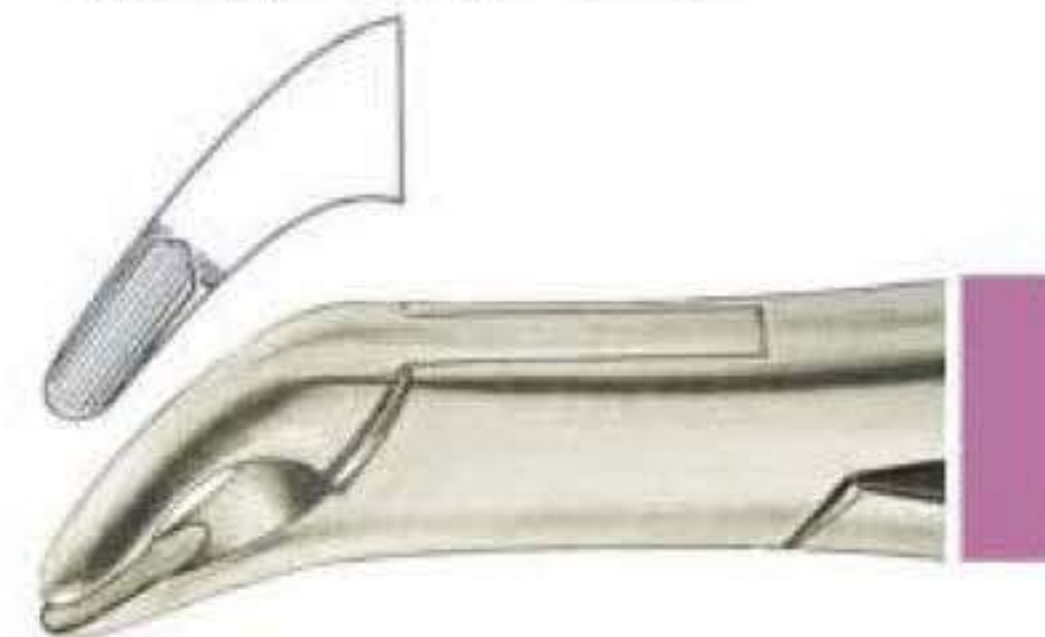

**NHS092**  
**# 151A**  
Cryer lower incisors, premolars, roots



**NHS-093**  
**# 151 S**  
Cryer lower incisors, premolars, roots

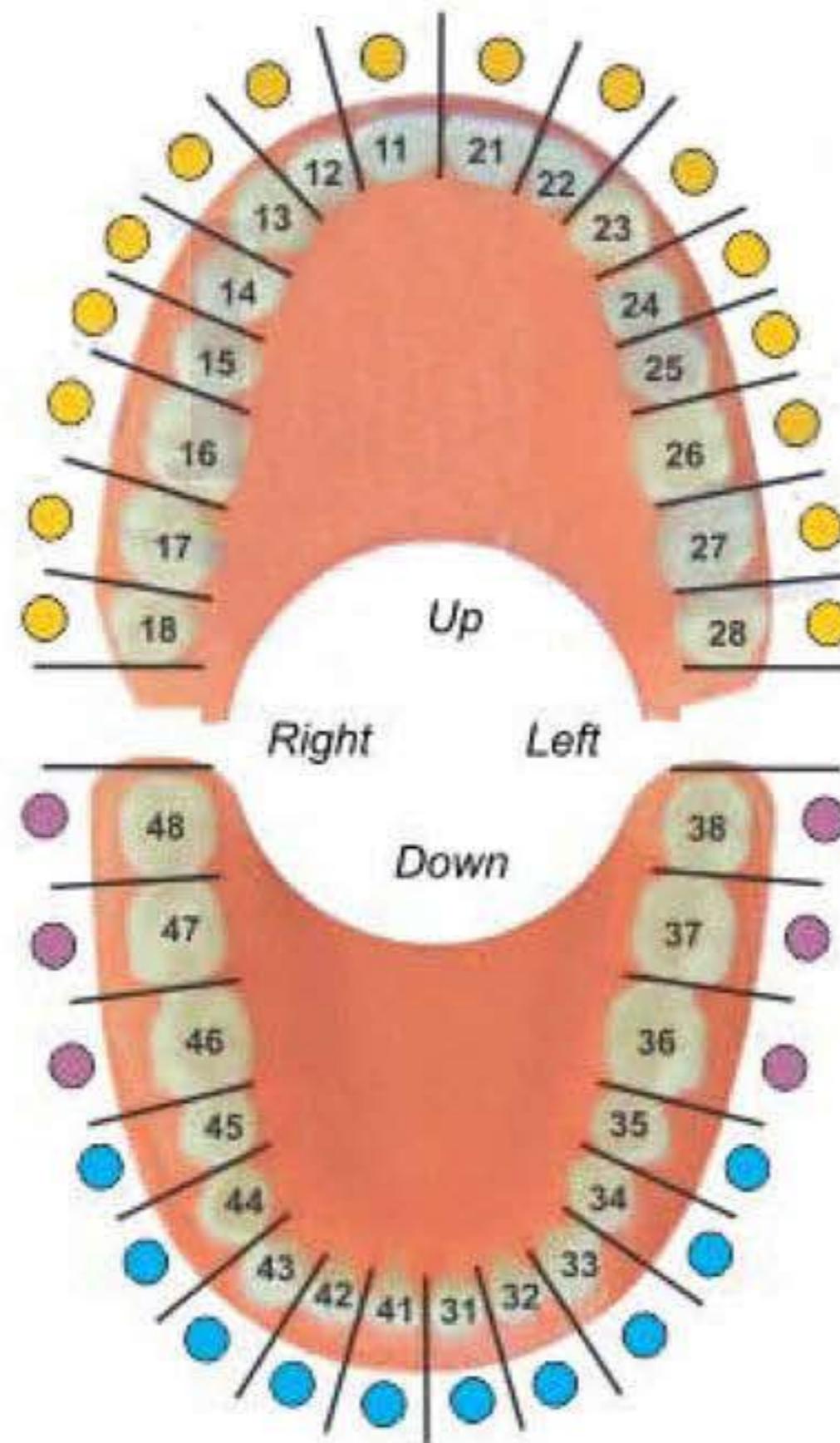

**NHS-094**  
**# 151**  
Cryer lower teeth, for children



**NHS-095**  
**# 286**  
upper incisors and roots

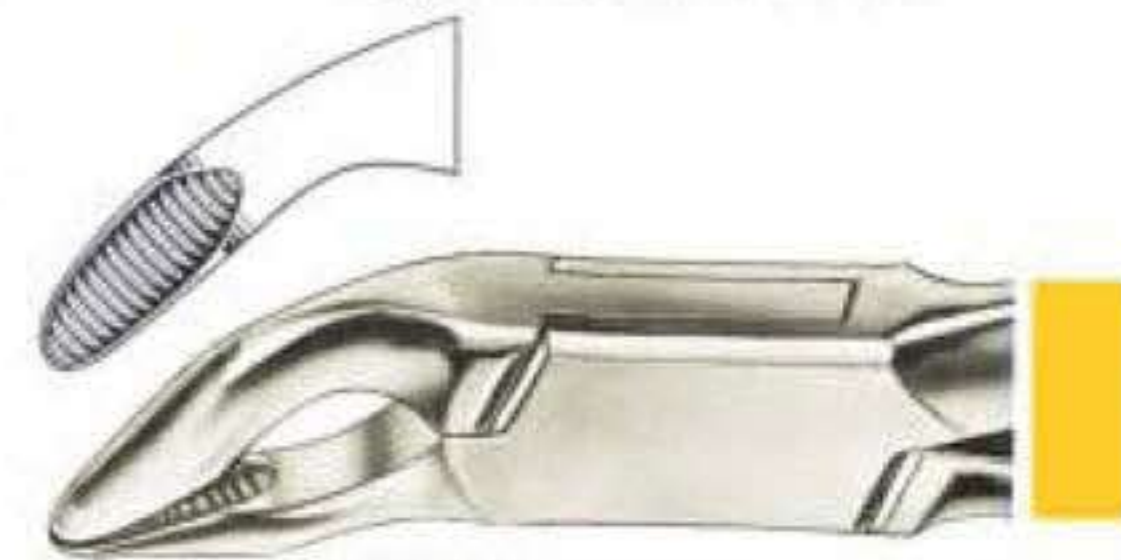

**NHS-096**  
Cohen universal forceps



**NHS-097**  
**# 89**  
Upper molars, right



**NHS-098**  
**# 23 S**  
Lower molars





## PLIERS FOR ORTHODONTICS & PROSTHETICS

- Щипцы для ортодонтии и протезирования
- Pincers pour l'orthodontie et la prothèse
- Zangen für Kieferorthopädie und Prothetik
- Щипці для ортодонції та протезування
- Alicates para ortodoncia y prótesis
- كمامة لتكوين الأسنان بروتيسيتيس

### BOX JOINT PLIERS

#### NHS-1327 Adams Plier Round Box

Adams pliers for bending wire arches and bends right angles for wires up to .022", .025 tip to beak. Length 125mm

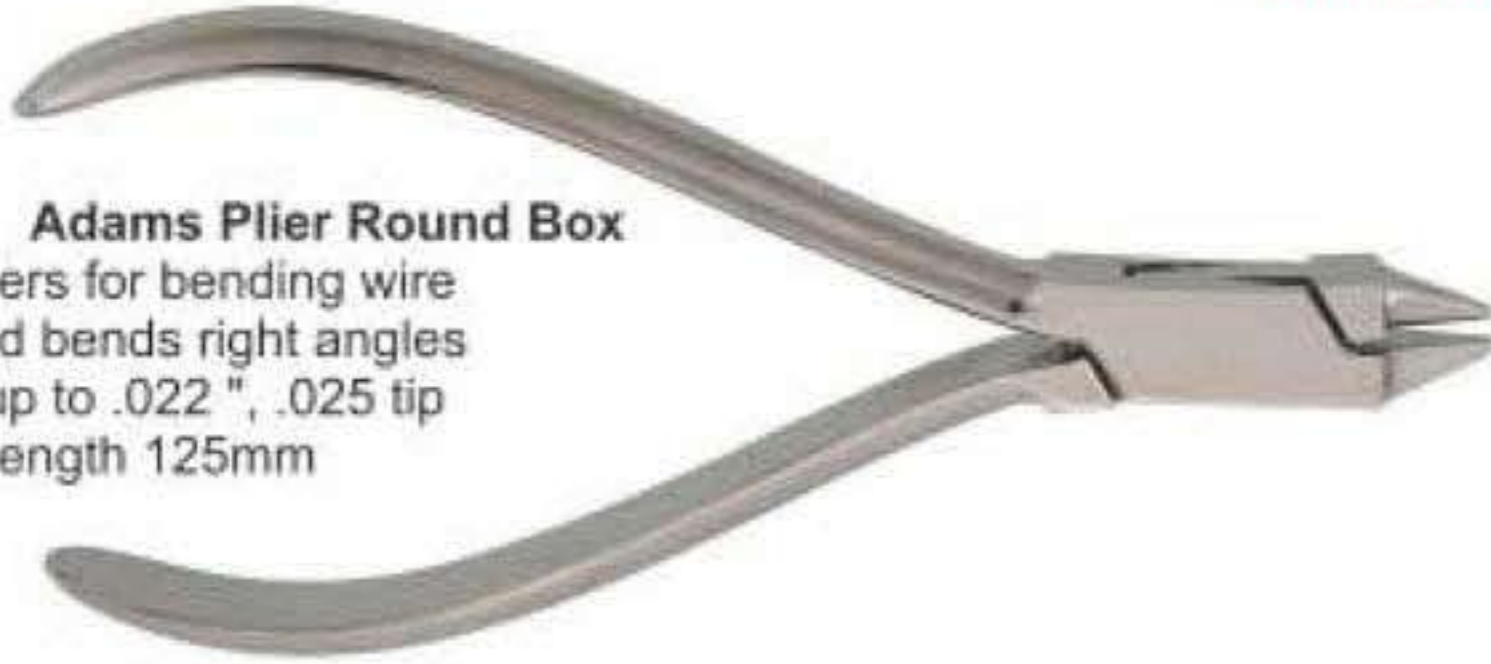

#### NHS1328 Falcon Beak Contouring Pliers.



#### NHS-1329 wires up to 0.020" / 0.7mm.



#### NHS-1330 Johnson Contouring Pliers



#### NHS-1331 Aderer Large wire bending and loop forming pliers



#### NHS1332 Tweed / angle rectangular arch forming & Torquing pliers



#### NHS-1333 Adams Plier Adams pliers for bending wire arches and bends right angles for wires up to .022", .025 tip to beak. Length 125mm

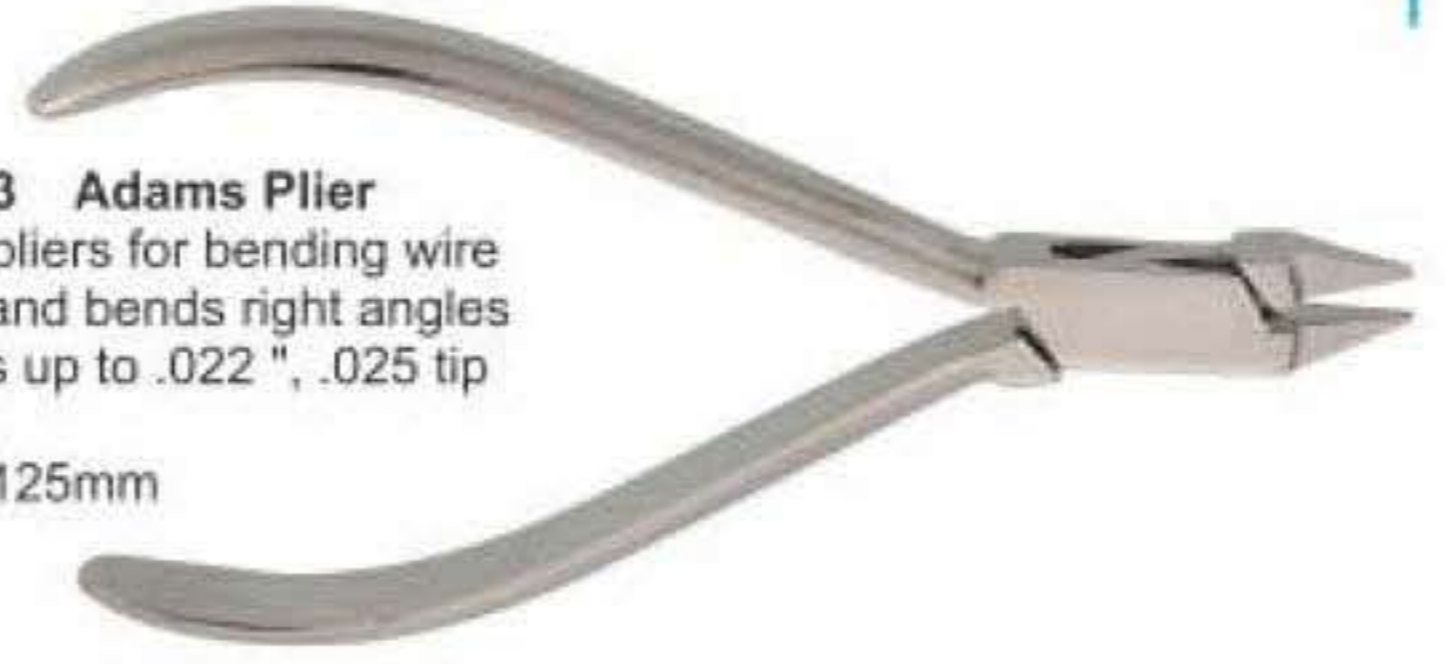

#### NHS-1334 Tweed Loop Formin Pliers



#### NHS-1335 Bird Beak Plier Standard Bird Beak Wire bending plier without notches, which is suitable as a universal utility tool. Length 125mm



#### NHS-1336 Mini Ligature cutters



#### NHS-1337 Small Fluch-cut distal and cutting Pliers with safety hold fitted with un-breakable, corrosion resistant and durable stainless steel tips



#### NHS-1338 Large Fluch-cut distal and cutting Pliers with safety hold fitted with un-breakable, corrosion resistant and durable stainless steel tips







## PLIERS FOR ORTHODONTICS & PROSTHETICS

- Щипцы для ортодонтии и протезирования
- Pincers pour l'orthodontie et la prothèse
- Zangen für Kieferorthopädie und Prothetik
- Щипці для ортодонції та протезування
- Alicates para ortodoncia y prótesis
- كمشة لتقويم الأسنان بروتیس

### BOX JOINT PLIERS

NHS-1339

**Tweed / Angel**

1.78mm (.070") wide tips arch forming and torquing pliers

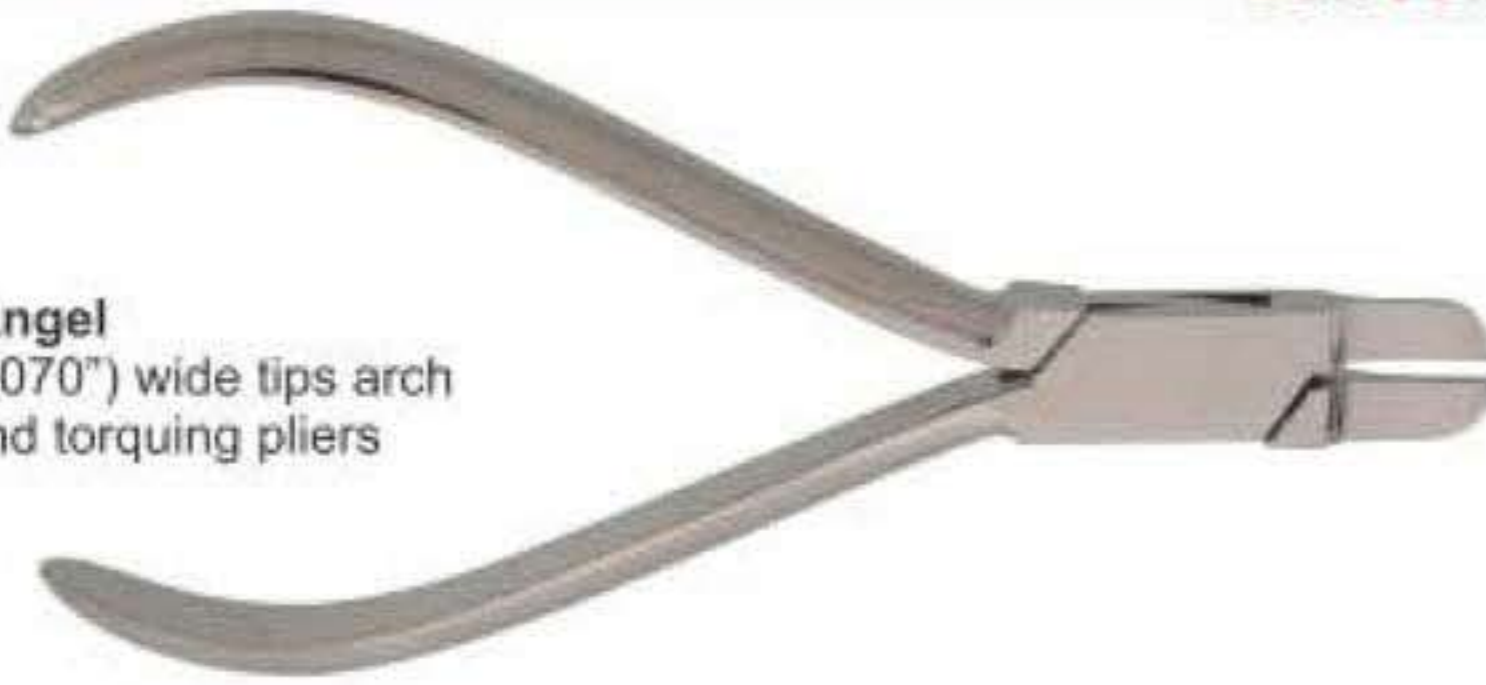

NHS-1345

**Contouring Plier**



NHS-1340

**Tweed / Angel**

1.78mm (.070") wide tips arch forming and torquing pliers



NHS-1346

**Bands & Crowns Plier**  
in order to skirt



NHS-1341

**Lingual / Palatal arch**  
forming pliers



NHS-1347

**Ligature Forming Pliers**



NHS-1342

**Aderer**

Facebow loop forming Pliers



NHS-1348

for double back and triple back bands in 0.30" / 0.76mm & 0.36" / 0.91mm lingual arch wires



NHS-1343

**Waldsavhs wire bending**  
and cutting pliers



NHS-1349

**Bird Beak Wire Bending**  
& cutting pliers



NHS-1344 **Aderer Plier**

For the manufacturing of appliances and activation of wires for wires up to .030" .fine tip and up to .036" mean tip. Length 130mm



NHS-1350

**Weingart Plier medium**

Weingart plier that are ideal due to their curved tip for setting sheets and is capable of bending the ends. Length 145mm

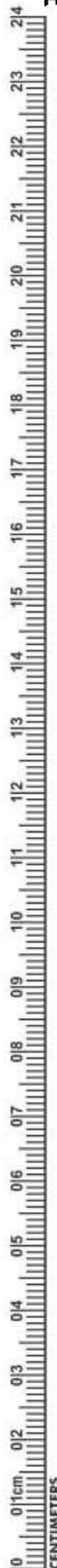
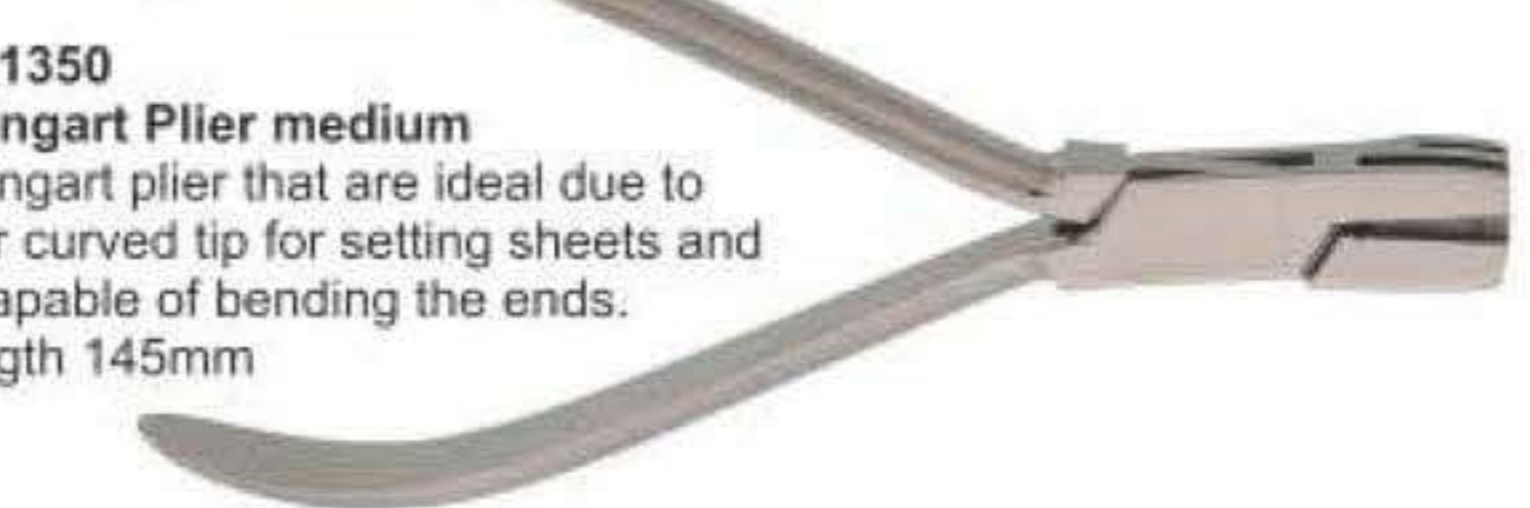



## PLIERS FOR ORTHODONTICS & PROSTHETICS

- Щипцы для ортодонтии и протезирования
- Pincers pour l'orthodontie et la prothèse
- Zangen für Kieferorthopädie und Prothetik
- Щипці для ортодонції та протезування
- Alicates para ortodoncia y prótesis
- كمامة لتكويم الأسنان بروستیتس

### LAP JOINT PLIERS



**NHS-1351**  
Distal End Cutter  
Regular with T.C

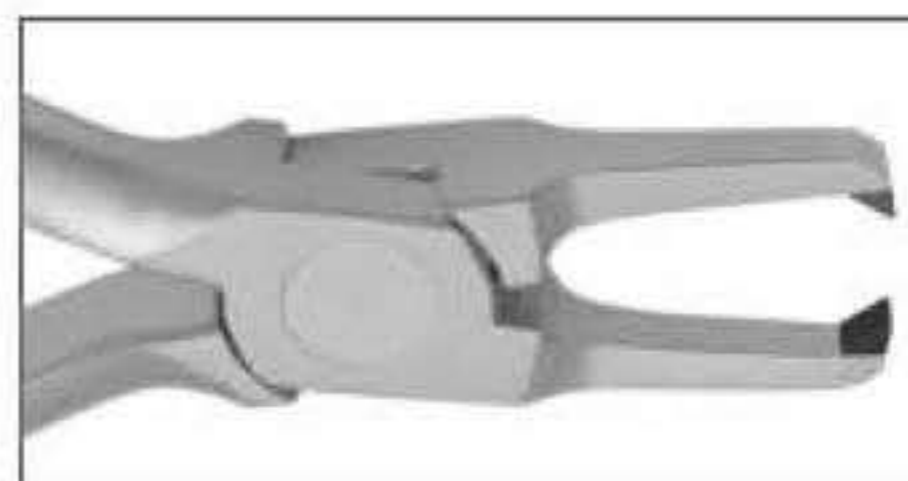

**NHS-1358**  
Bracket Remover Pliers  
Straight With T.C



**NHS-1352**  
Hard Wire Cutter With T.C



**NHS-1359**  
Bird Beak Plier With TC



**NHS-1353**  
Ligature Cutter Angled  
15° With T.C

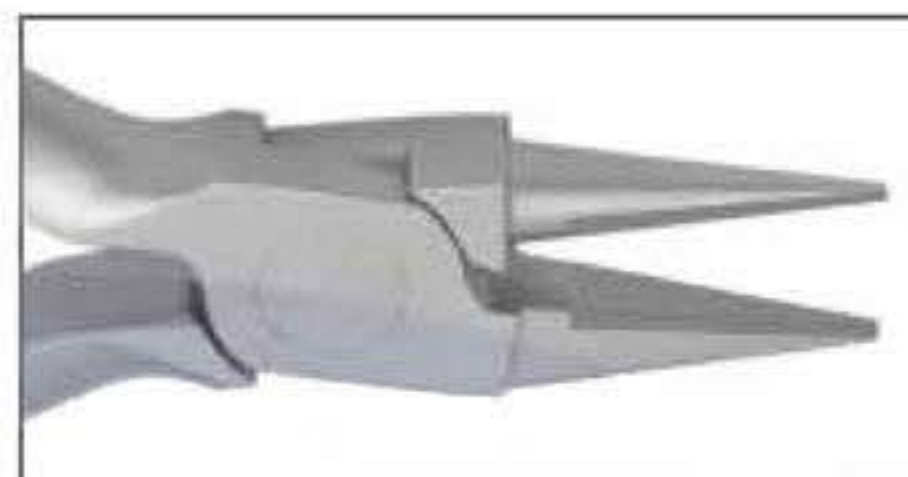

**NHS-1360**  
Light Wire Bird Beak  
Long Plier With TC



**NHS-1354**  
Light Wire Cutter Micro  
With T.C



**NHS-1361**  
Adam Plier With TC



**NHS-1355**  
Reversed Ligature  
Cutter Angled  
40° With T.C



**NHS-1362**  
Tweed Arch Forming Plier  
1.78mm With TC

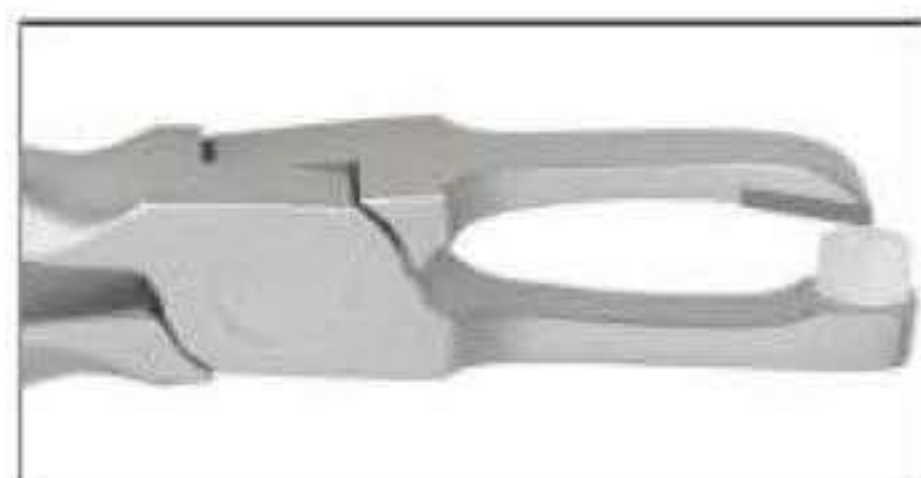

**NHS-1356**  
Posterior Band Remover Pliers  
Long With T.C



**NHS-1363**  
Weingart Plier Slim  
With TC



**NHS-1357**  
Posterior Band Remover Pliers  
Medium With T.C

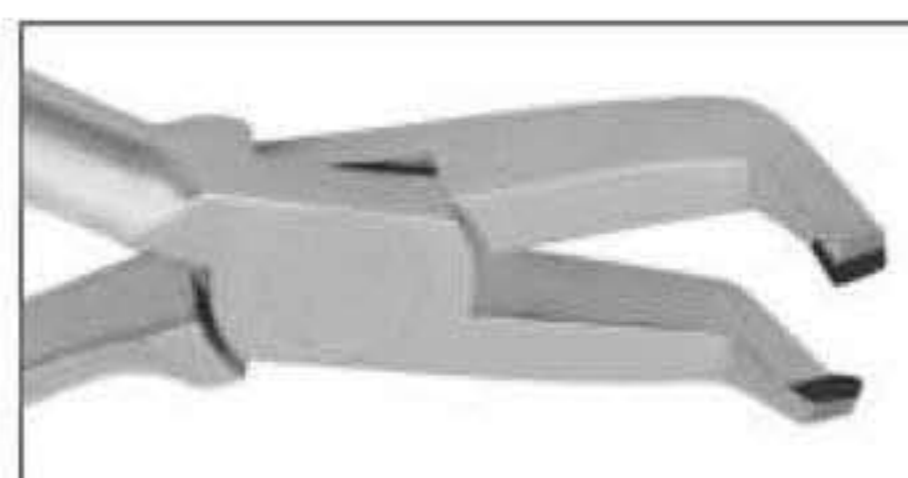

**NHS-1364**  
Bracket Remover Pliers  
Angled With T.C





## PLIERS FOR ORTHODONTICS & PROSTHETICS

- Щипцы для ортодонтии и протезирования
- Pincers pour l'orthodontie et la prothèse
- Zangen für Kieferorthopädie und Prothetik
- Щипці для ортодонції та протезування
- Alicates para ortodoncia y prótesis
- كمشة لتقويم الأسنان بروتیسیس

### LAP JOINT PLIERS

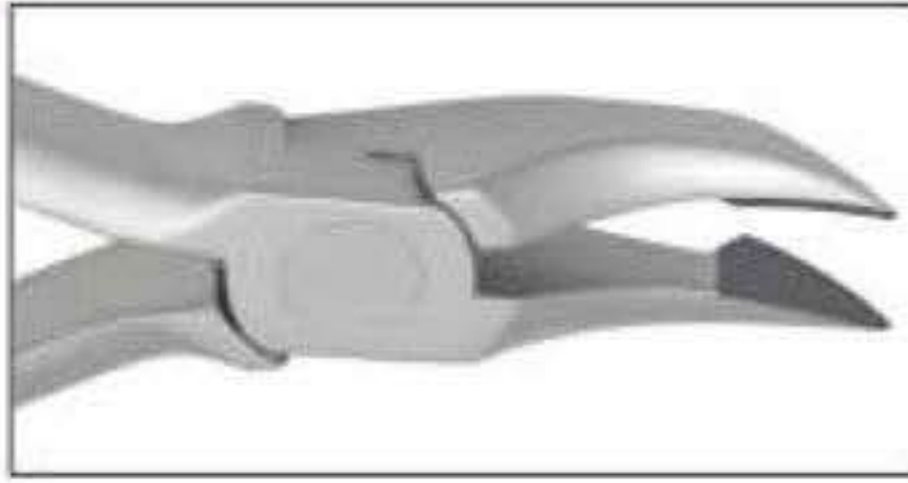

**NHS-1365**  
Weingart Plier Regular  
With TC

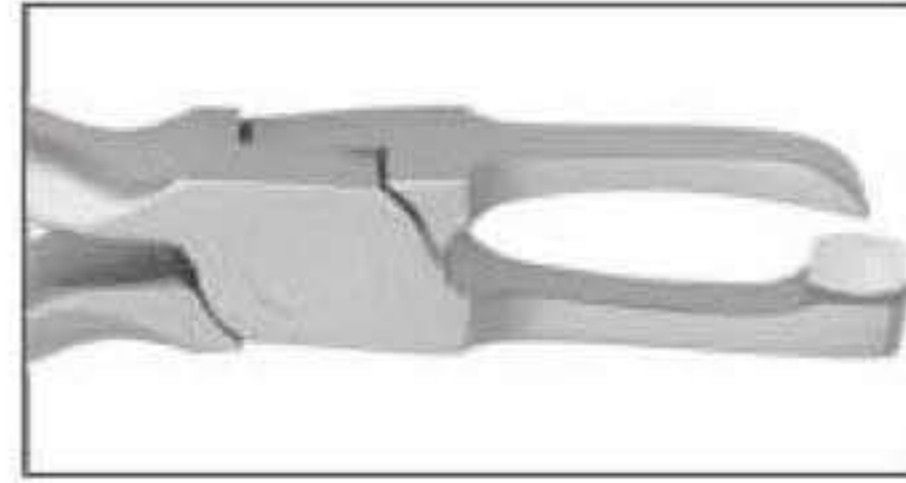

**NHS-1372**  
Posterior Bend Remover  
Plier Long



**NHS-1366**  
Weingart General Utility Plier  
Long Mouth With TC

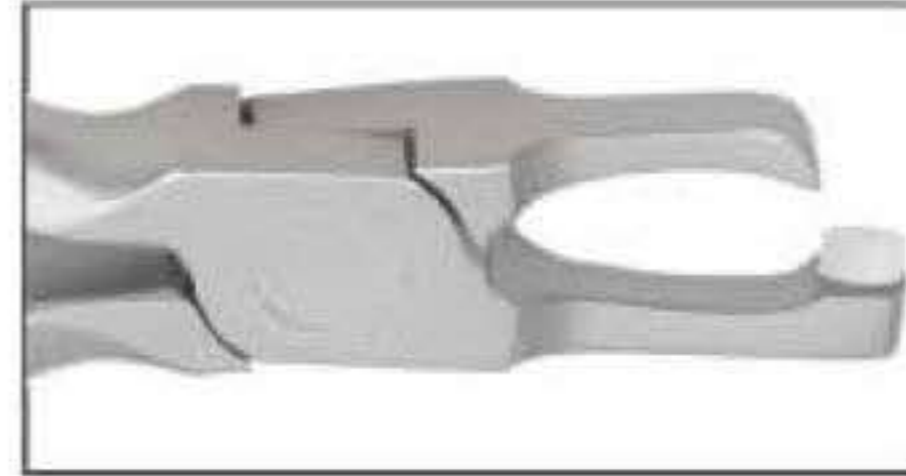

**NHS-1373**  
Posterior Bend Remover  
Plier Short

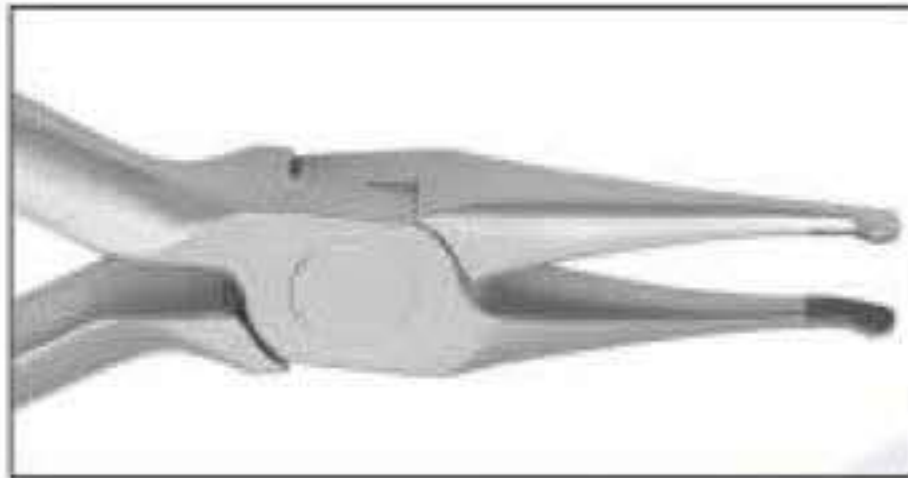

**NHS-1367**  
How Plier Straight  
With TC



**NHS-1374**  
Posterior Bend Remover  
Plier Medium

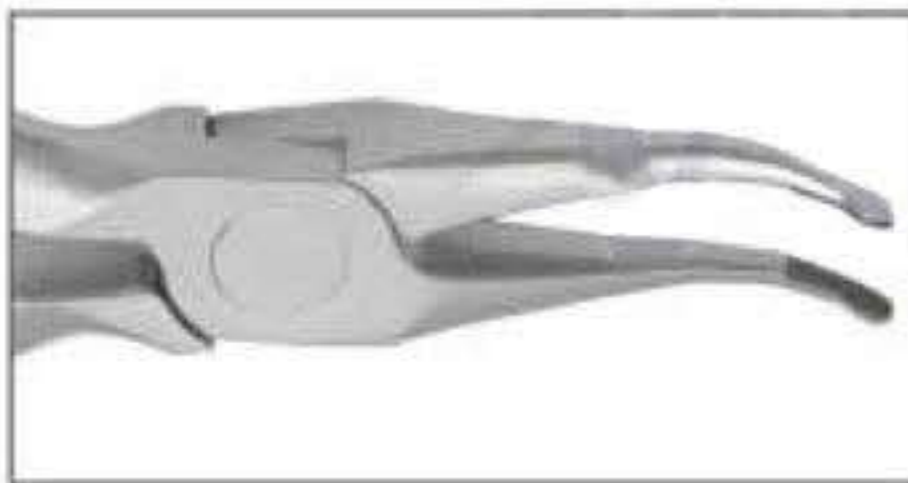

**NHS-1368**  
How Plier Curved  
With TC

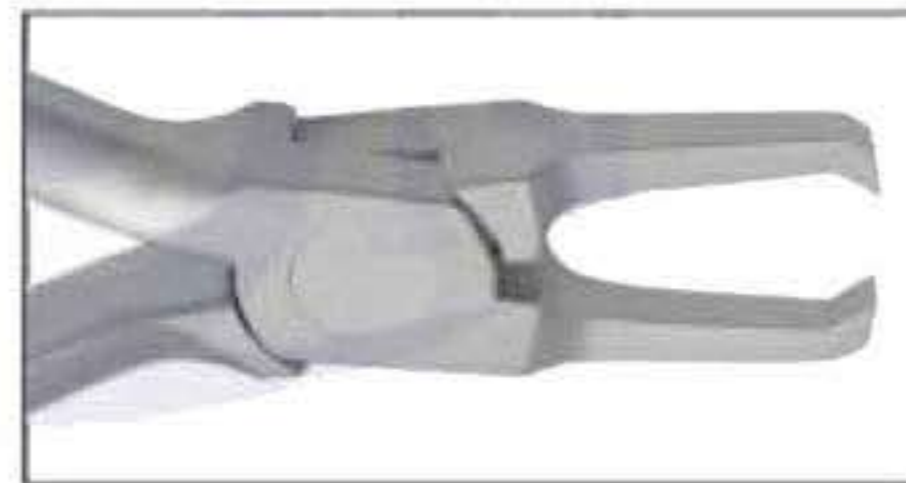

**NHS-1375**  
Bracket Remover Plier  
Straight



**NHS-1369**  
Step Pliers with T.C  
0.5mm

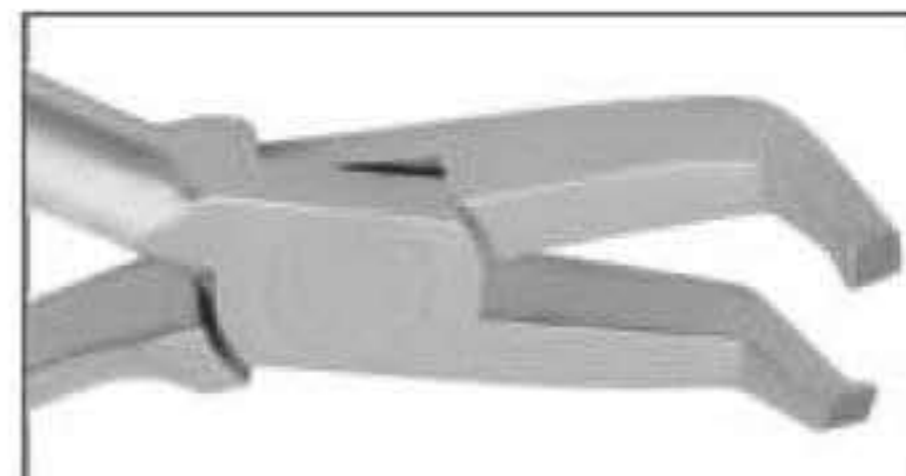

**NHS-1376**  
Bracket Remover  
Angulated  
Plier

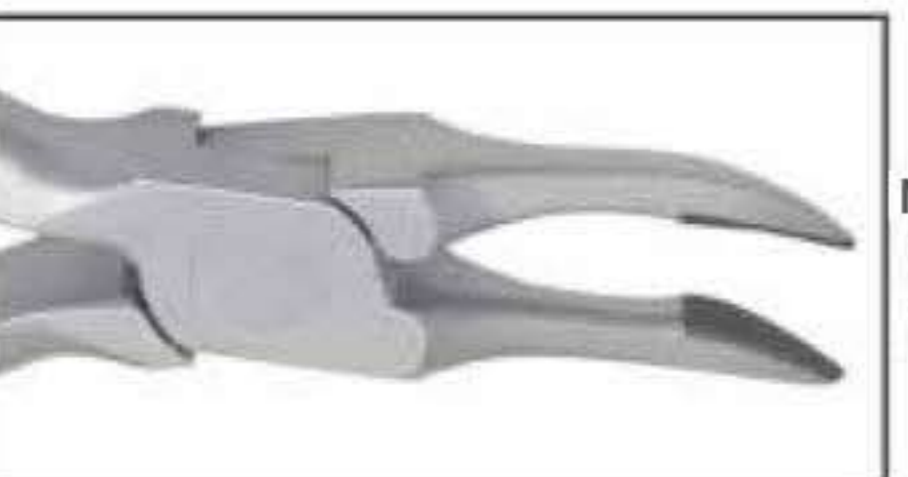

**NHS-1370**  
Weingart Plier Utility  
With TC

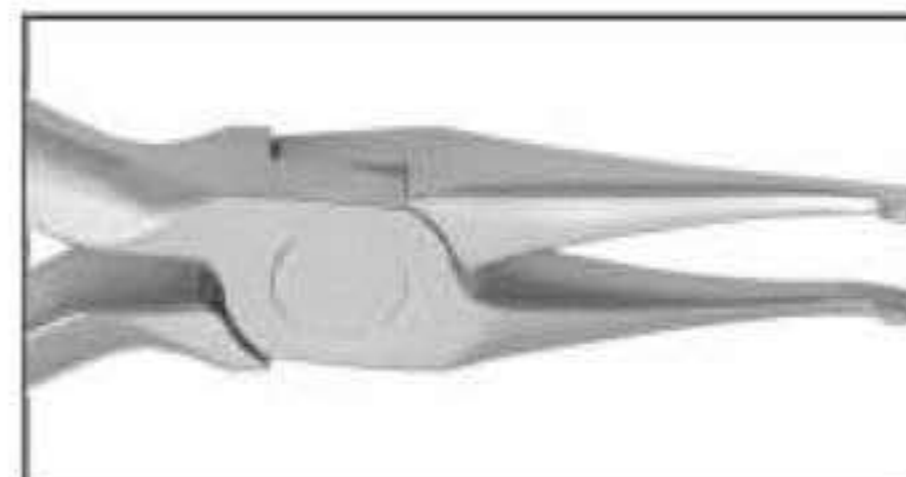

**NHS-1377**  
How Plier Straight

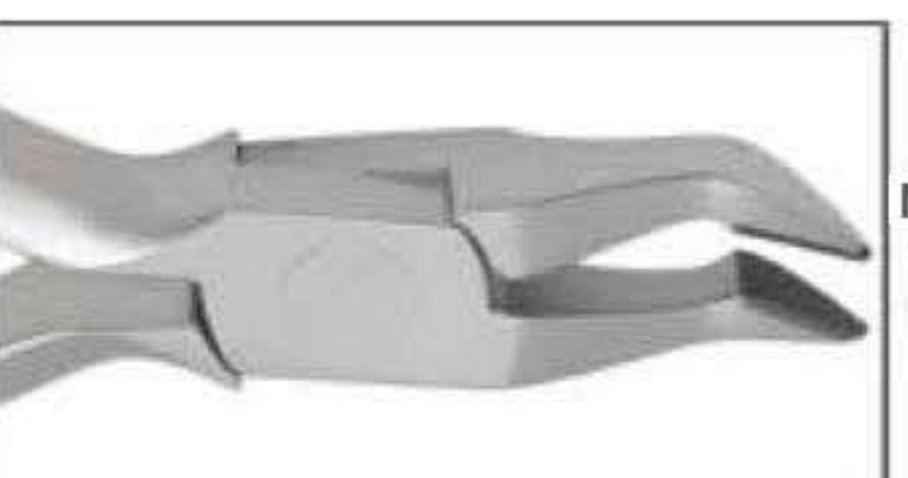

**NHS-1371**  
Weingart Plier Universal  
With TC 45°



**NHS-1378**  
Bird Beak Angled  
Bending Plier

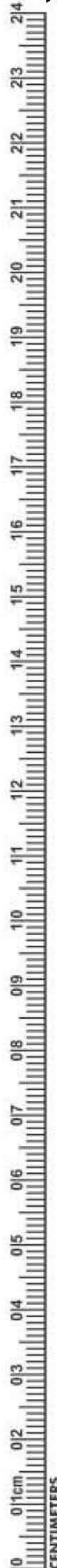



## PLIERS FOR ORTHODONTICS & PROSTHETICS

- Щипцы для ортодонтии и протезирования
- Щипці для ортодонтії та протезування
- Pinces pour l'orthodontie et la prothèse
- Alicates para ortodoncia y prótesis
- Zangen für Kieferorthopädie und Prothetik
- كماشة لتقويم الأسنان بروتستيس

### LAP JOINT PLIERS

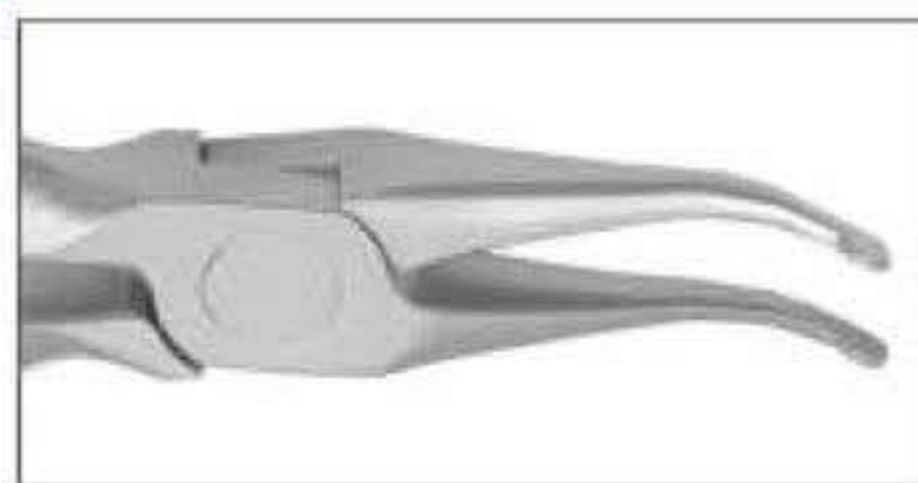

**NHS-1379**  
How Plier Curved



**NHS-1386**  
Tweed Cutter Plier With Groove



**NHS-1380**  
Hammer Head Tie Back Plier



**NHS-1387**  
Round Nose Plier

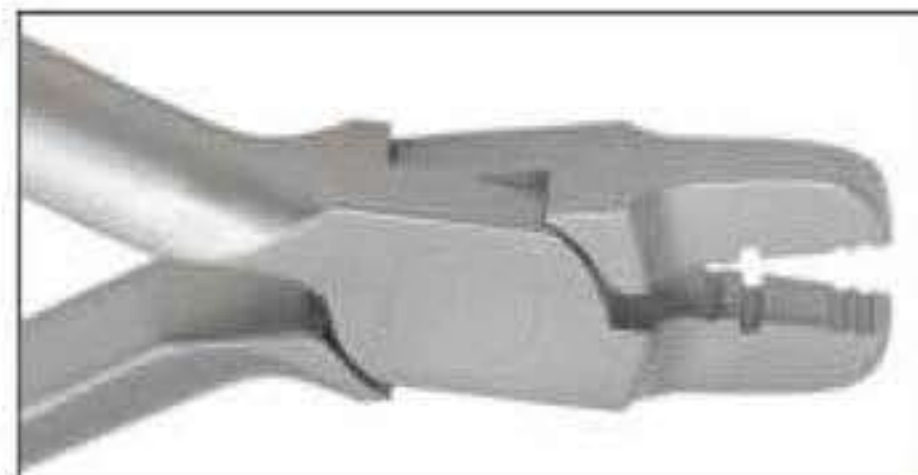

**NHS-1381**  
Arch Forming Pliers



**NHS-1388**  
Adam Plier



**NHS-1382**  
Regular Tweed Arch Forming Pliers 1.78mm



**NHS-1389**  
Jara Beak Plier



**NHS-1383**  
Bird Beak with Cutter Pliers 3 Groove

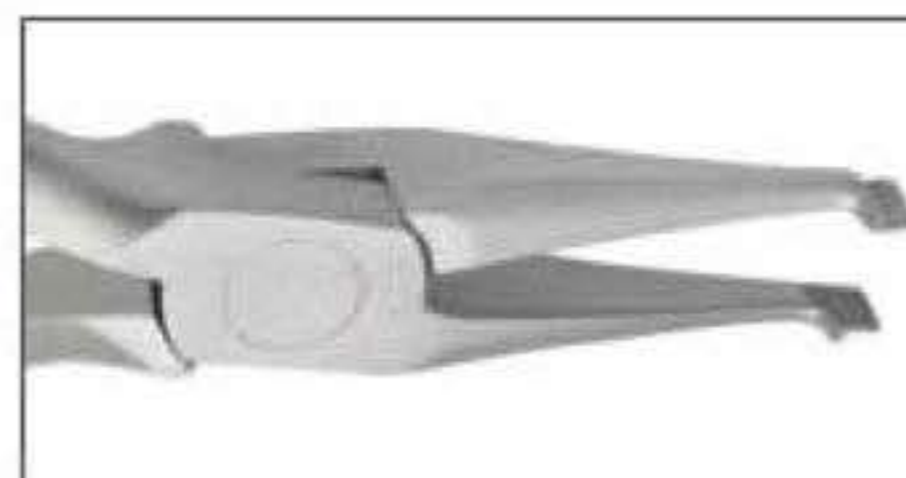

**NHS-1390**  
Band Seating Plier

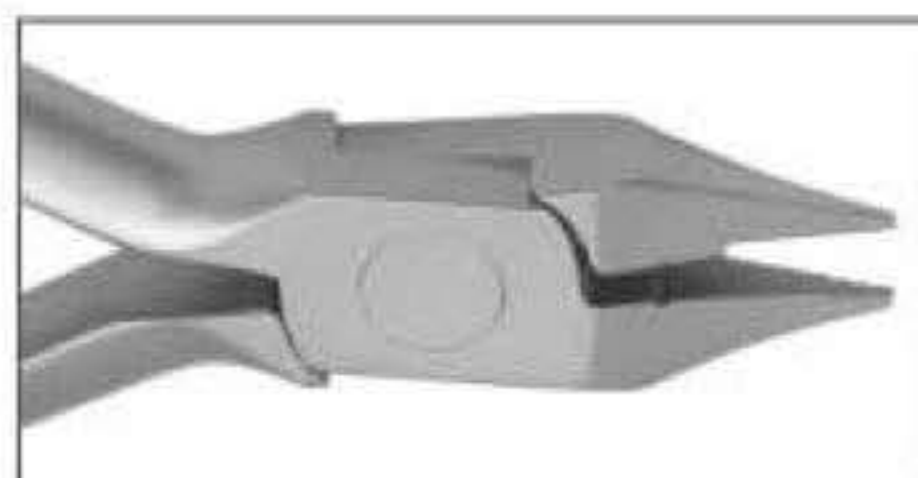

**NHS-1384**  
Light Wire Bird Beak Pliers With Groove

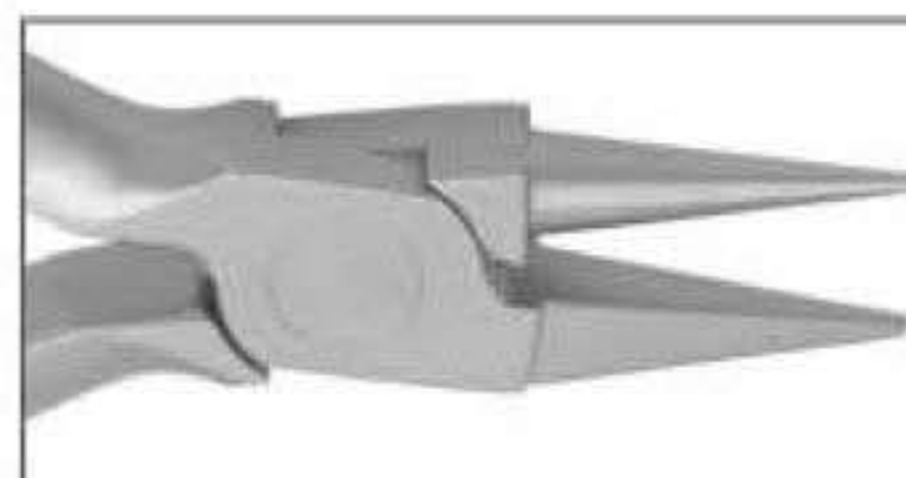

**NHS-1391**  
Light Wire Bird Beak Long Plier



**NHS-1385**  
Tweed Loop Plier



**NHS-1392**  
Light Wire plier two step groove 0.51mm/.020"





## PLIERS FOR ORTHODONTICS & PROSTHETICS

- Щипцы для ортодонтии и протезирования
- Pincers pour l'orthodontie et la prothèse
- Zangen für Kieferorthopädie und Prothetik
- Щипці для ортодонції та протезування
- Alicates para ortodoncia y prótesis
- كمشة لتقويم الأسنان بروستتیس

### LAP JOINT PLIERS



**NHS-1393**  
Ball Hook Crimping Plier



**NHS-1394**  
Marcotte Looping Plier



**NHS-1395**  
Tweed Loop Plier

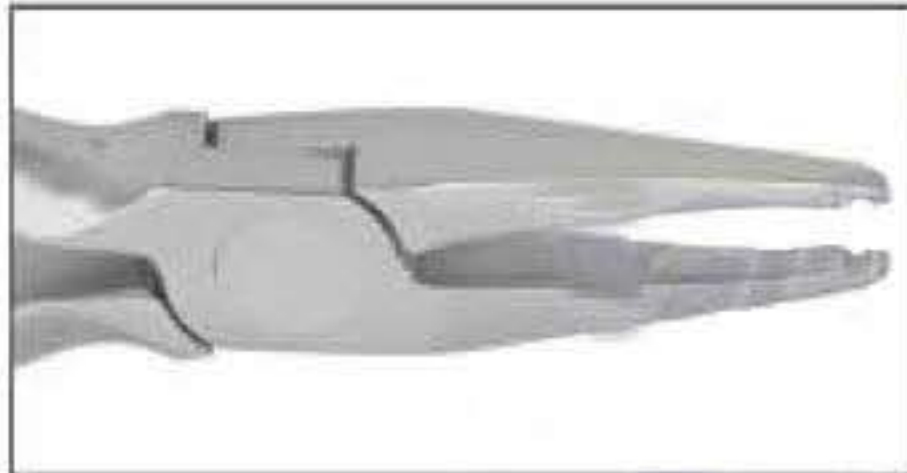

**NHS-1396**  
Palatal Arch Plier



**NHS-1397**  
Nance Plier



**NHS-1398**  
Young Plier with Grooved



**NHS-1399**  
Wingurt Plier Slim



**NHS-1400**  
Tweed loop Forming  
Plier TC.

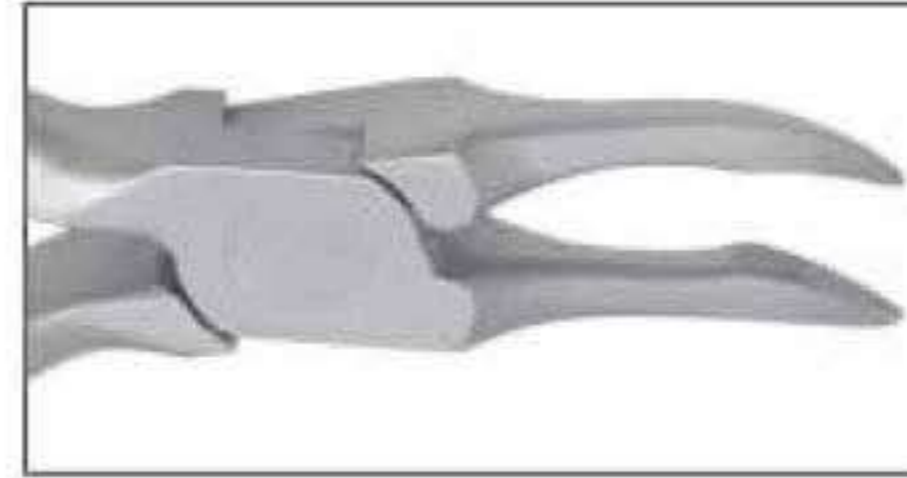

**NHS-1401**  
Wingurt Utility Plier

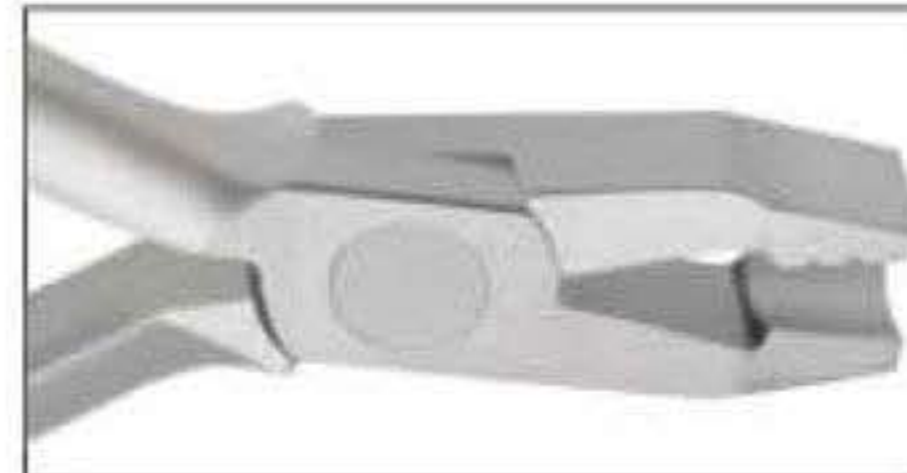

**NHS-1402**  
De La Rosa Pliers  
with Grooved



**NHS-1403**  
De La Rosa Pliers

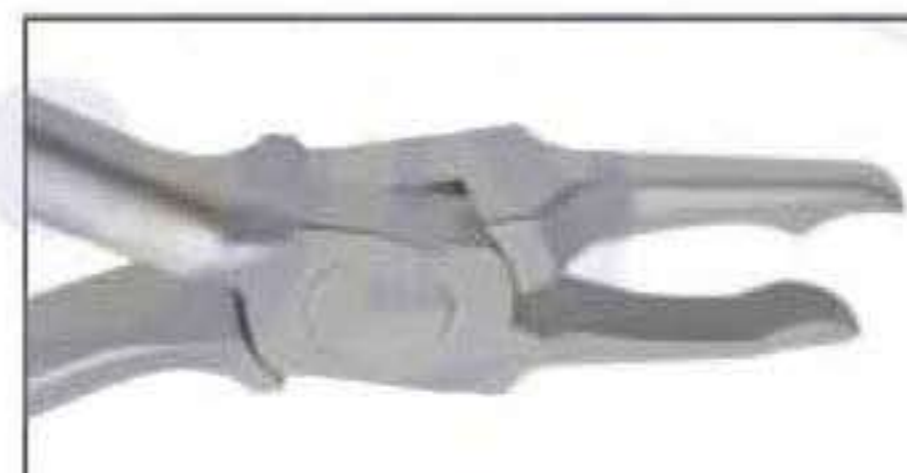

**NHS-1404**  
Crown and Band  
Contouring Pliers



**NHS-1405**  
Flat Nose Plier with Serration



**NHS-1406**  
Flat Nose Plier Smooth

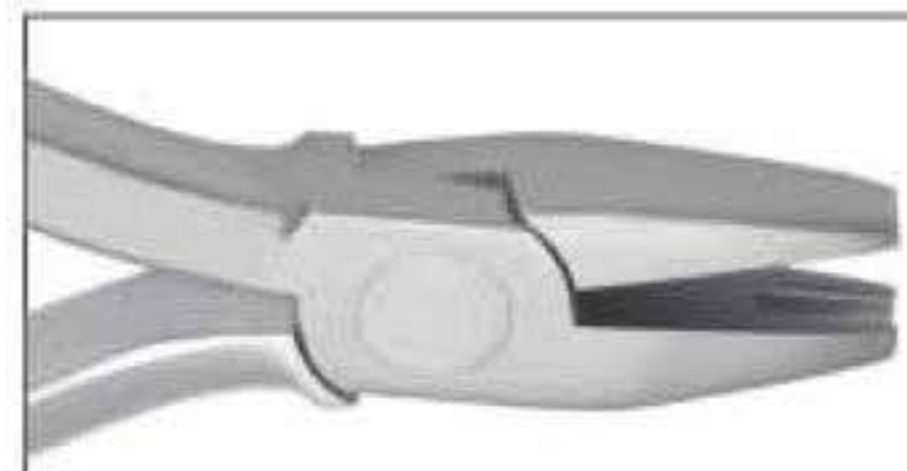

**NHS-1407**  
Stop V Bending Plier





## PLIERS FOR ORTHODONTICS & PROSTHETICS

- Щипцы для ортодонтии и протезирования
- Pincers pour l'orthodontie et la prothèse
- Zangen für Kieferorthopädie und Prothetik
- Щипці для ортодонції та протезування
- Alicates para ortodoncia y prótesis
- كمامة لتكويم الأسنان بروستیتس

### LAP & L-KEY JOINT PLIERS

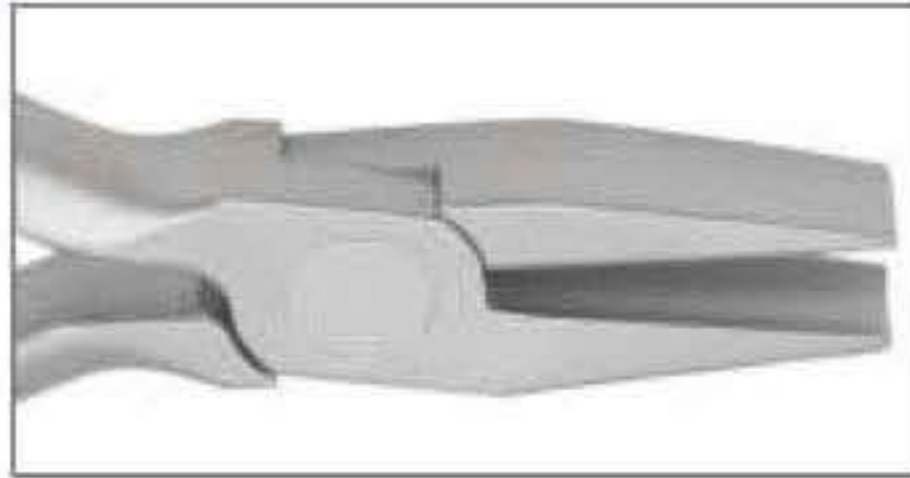

**NHS-1408**  
Hollowchop Contouring  
Pliers

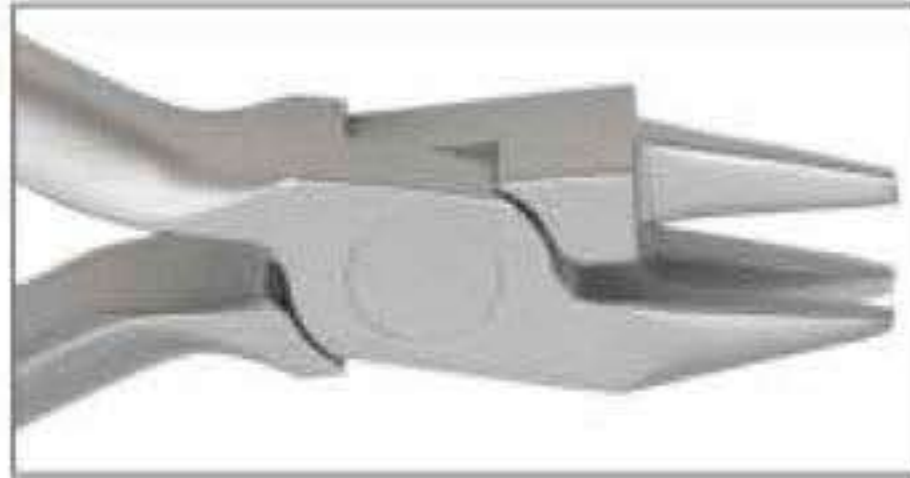

**NHS-1409**  
Lap-Joint Three Prong Plier



**NHS-1410**  
Three Prong Pliers Regular

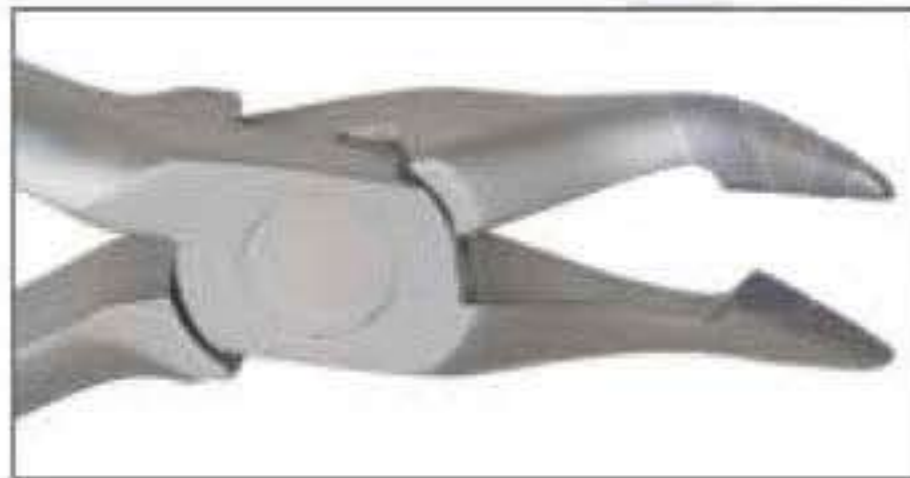

**NHS-1411**  
Lingual Plier Weingart  
Regular Long Handle 35°



**NHS-1412**  
Lingual Plier Long Handle  
90° Angled

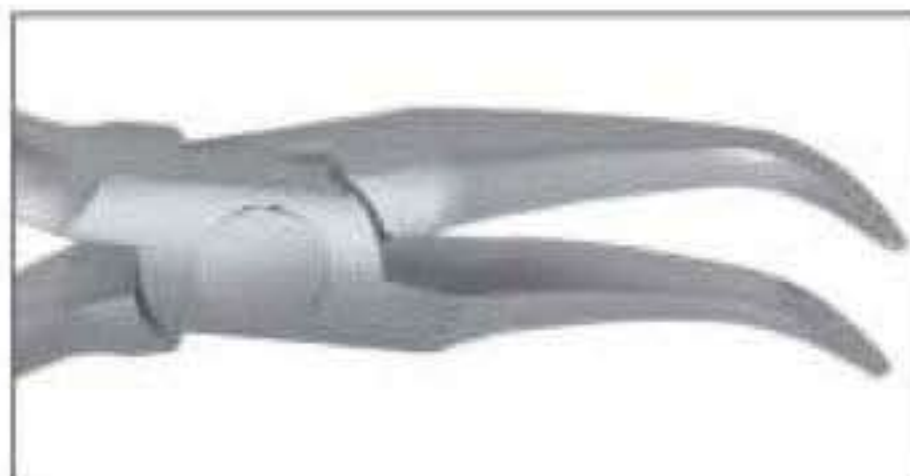

**NHS-1413**  
Lingual Weingart Plier Fine  
Long Handle 60° Angled



**NHS-1414**  
Direct Bonding Bracket  
Remover Plier TC.



**NHS-1415**  
Pin & Ligature Cutters  
TC.



**NHS-1416**  
Mini Pin & Ligature  
Cutter TC.



**NHS-1417**  
Standard Ligature  
Cutter TC.



**NHS-1418**  
V Bend Stop Plier  
TC.



**NHS-1419**  
Angled Direct Bond Bracket  
Remover TC.





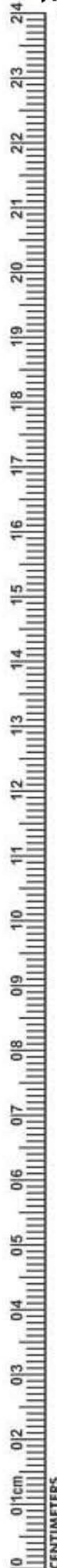

**NHS-1420**  
Distal end Cutter, Safety Hold Plier  
(Ideal for Cutting Wire) TC.



**NHS-1421**  
Hook Crimping Plier Angled  
Straight TC.



**NHS-1422**  
3 Prong Clasp Adjustable  
Plier TC.



**NHS-1423**  
Utility Plier Weingart TC.



**NHS-1424**  
Direct Bracket Remover  
TC.



**NHS-1425**  
Straight Direct Bond Bracket  
Remover TC.



**NHS-1426**  
Pin Holding Plier TC.



**NHS-1427**  
Hard wire cutters



**NHS-1428**  
Elastic Separating Plier  
Round Handle



**NHS-1429**  
Elastic  
Separating Plier



**NHS-1430**  
**BSI-1431**  
Smaha  
Elastomeric  
ligature  
placing forceps  
140 mm



**NHS-1432**  
Elastomeric  
ligature placing  
forceps with  
groove  
Falcon 140 mm



**NHS-1433**  
Elastomeric  
ligature placing  
forceps with  
groove  
Falcon 140 mm





# Normal Anatomy – Dental Implants

Bone Level Normal  
(No Bone Loss)

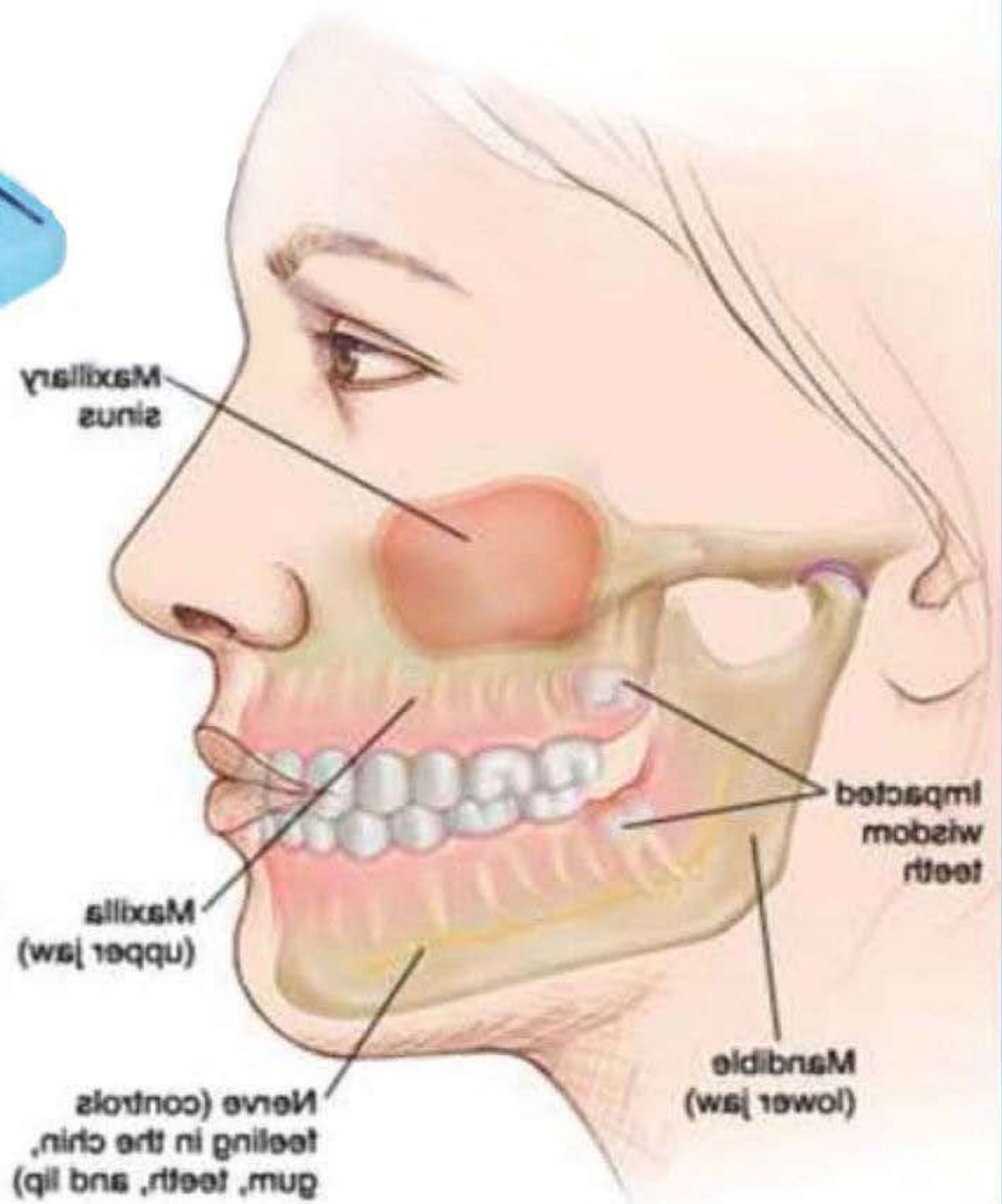
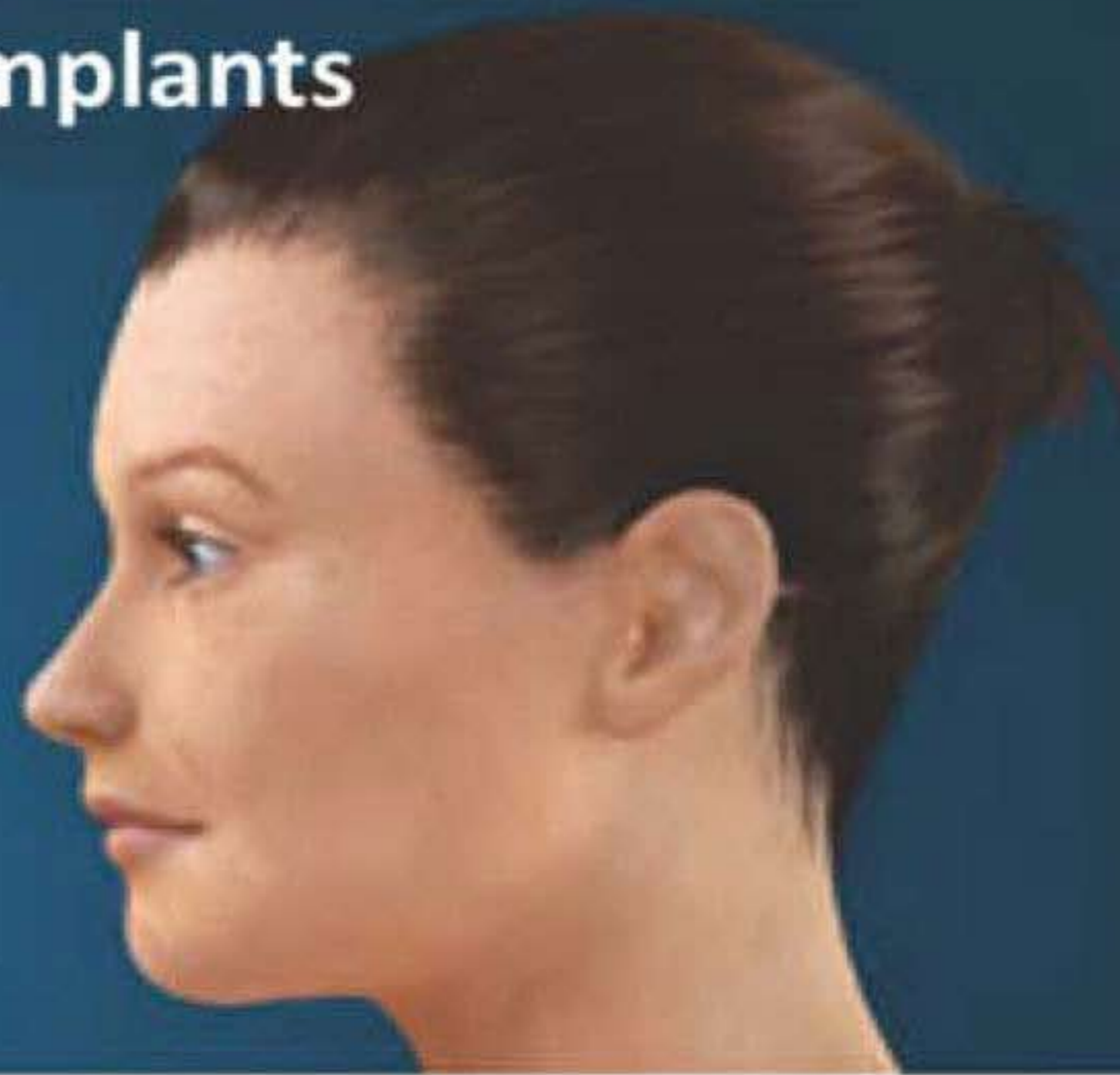
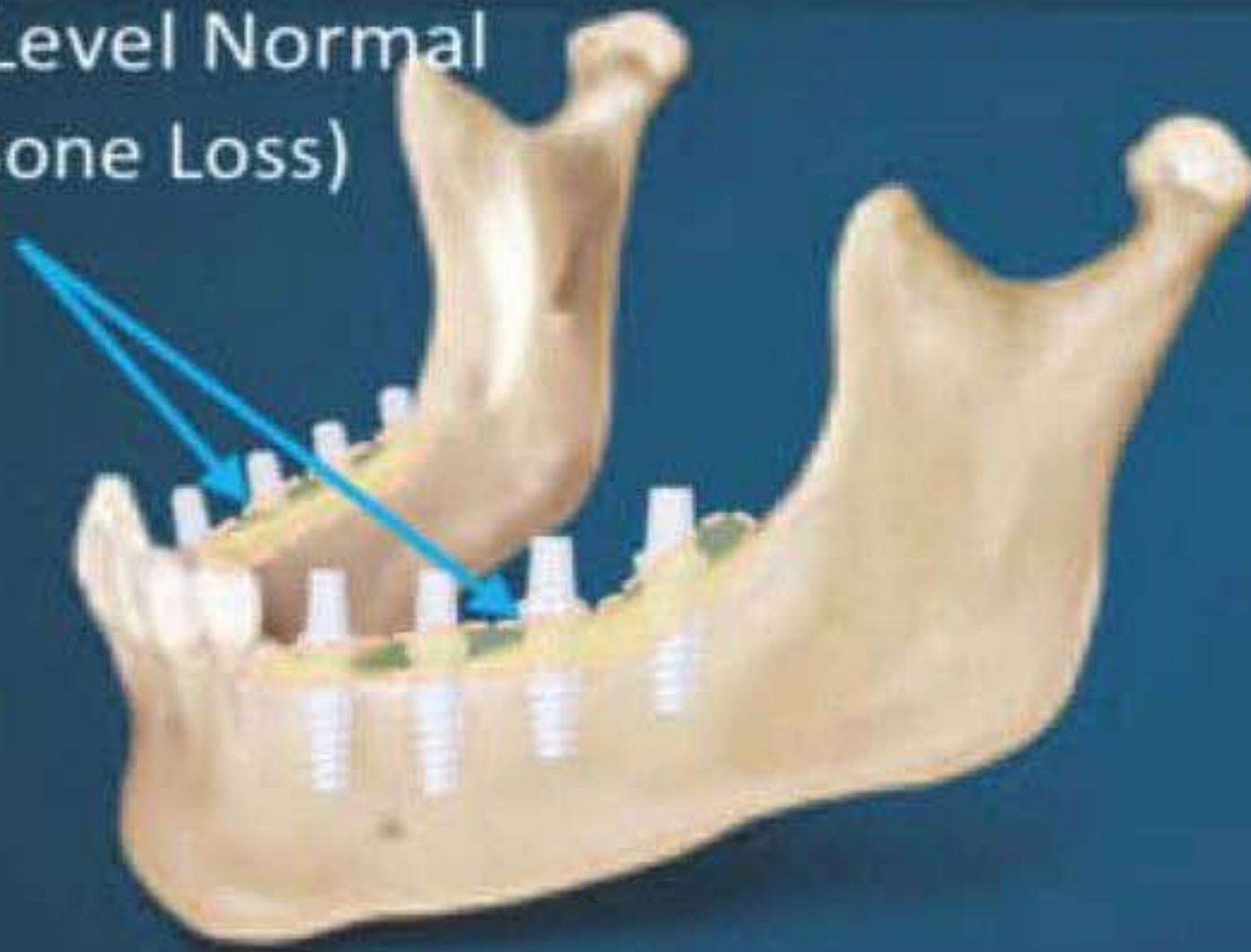





- Инструменты для имплантологии
- Implantologie
- Implantologie

- Инструменти для імплантології
- Implantologia
- زراعة الأسنان

IMPLANT GAGES



**NHS-1434**  
**Multifunctional Meter**  
 Length 90 mm,  
 different sizes,  
 8-10-11mm,  
 corrosion-resistant

**NHS-1435**  
**Multifunctional Meter**  
 Length 90 mm,  
 different sizes,  
 5-13-15-17 mm,  
 corrosion-resistant

**NHS-1436**  
**Measuring Probe**  
 Length 170 mm,  
 hand shape or flexible  
 (6-8-10-14-16 mm),  
 corrosion-resistant

NHS-1437

NHS-1438

NHS-1439

NHS-1440

IMPLANT GAGES



NHS-1441

NHS-1442

NHS-1443



- Инструменты для имплантологии
- Implantologie
- Implantologie

- Инструменти для імплантології
- Implantoloia
- زراعة الأسنان



**NHS-1444**  
**Clamp, Osteometer**  
Length about 155 mm,  
ridge width measurement,  
two-sided scale,  
measuring  
range 0 - 25 mm



**NHS-1445**  
**Measuring Loop**  
straight length 90 mm,  
measuring range  
0 - 40 mm,



**NHS-1446**  
**Measuring Loop**  
angled, length 90 mm,  
measuring range  
0 - 40 mm,



**NHS-1447**  
**Measuring loop, Castroviejo**  
angled, length 175 mm,  
measuring range 0 - 40 mm,  
with window



**NHS-1448**  
**Boley Gauge**  
Stainless Steel



**NHS-1449**  
**Measuring Loop**  
angled, length  
175 mm,  
measuring range  
0 - 40 mm,



**NHS-1450**  
**Measuring Loop**  
straight length  
175 mm,  
measuring range  
0 - 40 mm,



**NHS-1451**  
Fig. 1  
Iwanson  
spring caliper  
For metal and  
porcelain.



**NHS-1452**  
Fig. 2  
Iwanson  
spring caliper  
For wax.



**NHS-1453**  
**Bone Thickness Gauge**  
40mm, 180mm



**NHS-1454**  
**Gauge**  
for measuring  
distances  
(0 - 90 mm),







# EXTRACTING FORCEPS (American Pattern)

- Щипцы экстракционные (американская форма)
- Daviers - forme américaine
- Fórceps de extracción - forma americana
- Щипці екстракційні (американська форма)
- Pinzere per estrazione - forma americana
- استخراج الملقط (النمط الأمريكي)

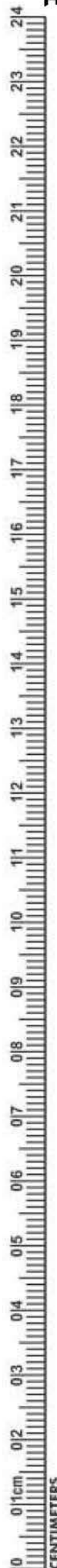
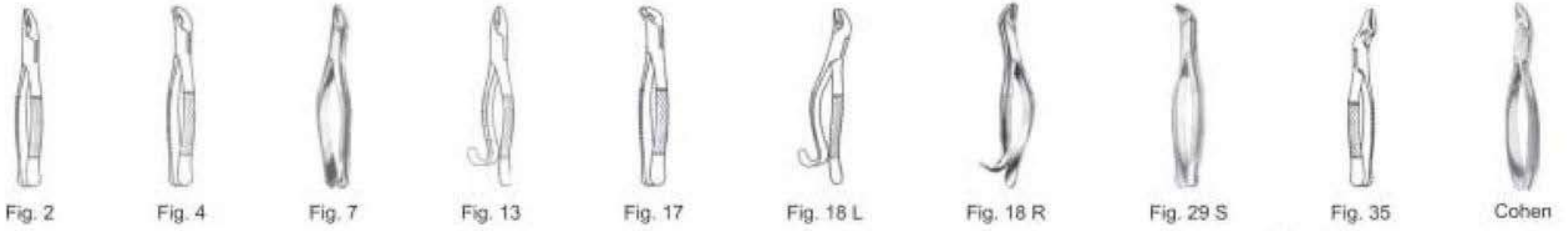

NHS-099 # 2 upper and lower roots



NHS-100 # 4 upper and lower premolars

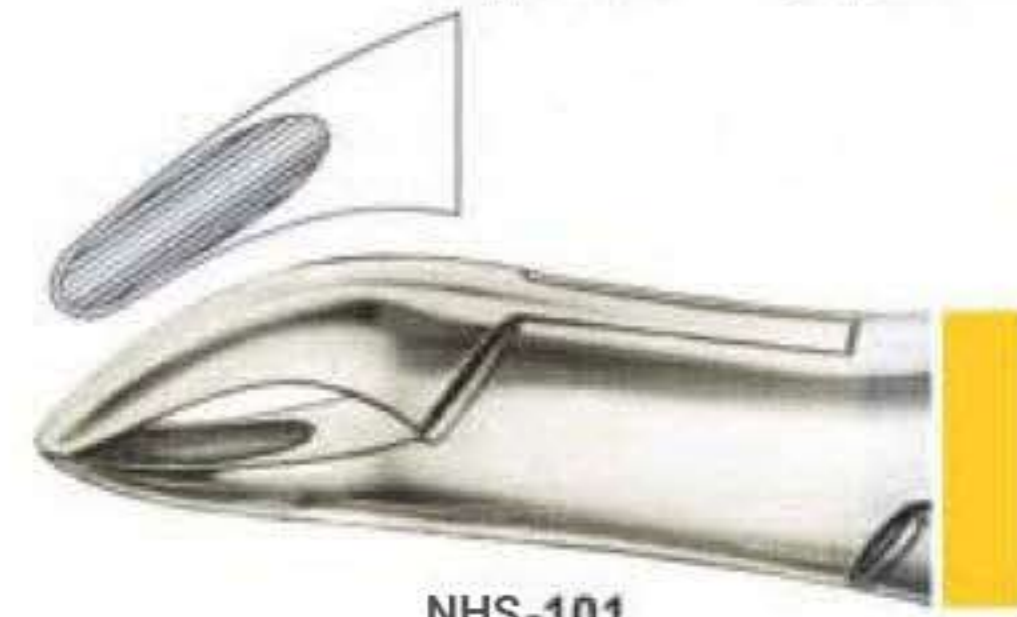

NHS-101 # 7 upper roots

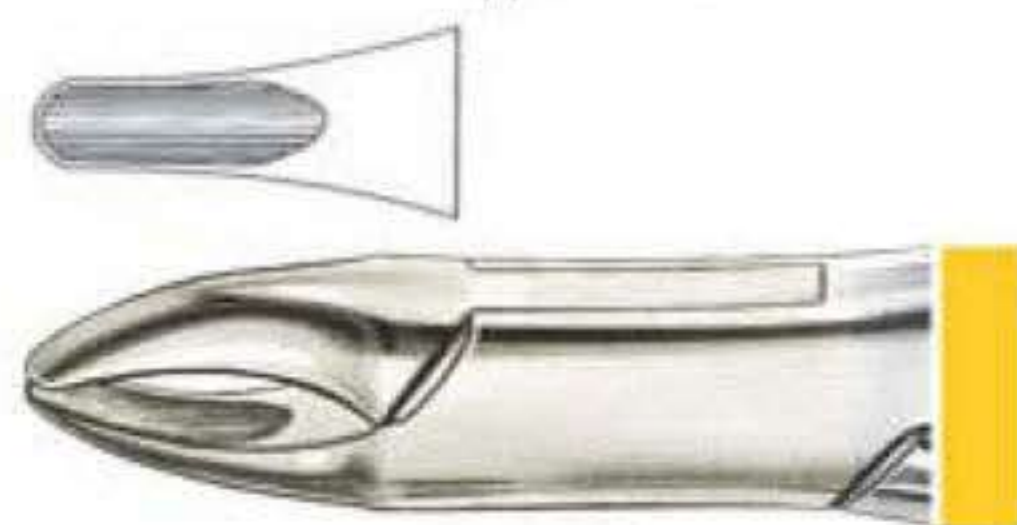

NHS-102 # 13 upper incisors



NHS-103 # 17 lower molars

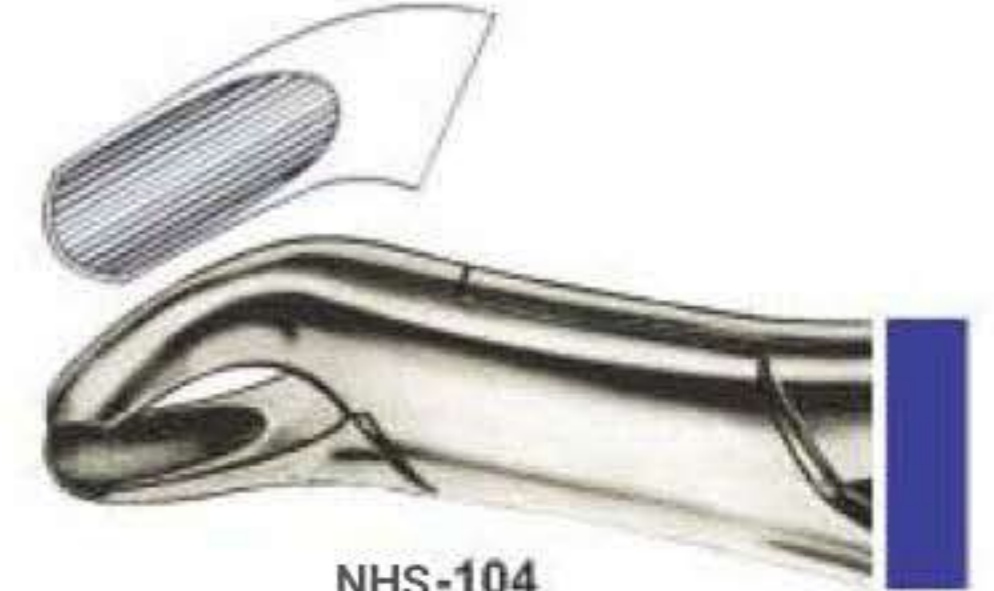

NHS-104 # 18 L Harris upper molars, left



BSI-105 # 18R Harris upper molars, right

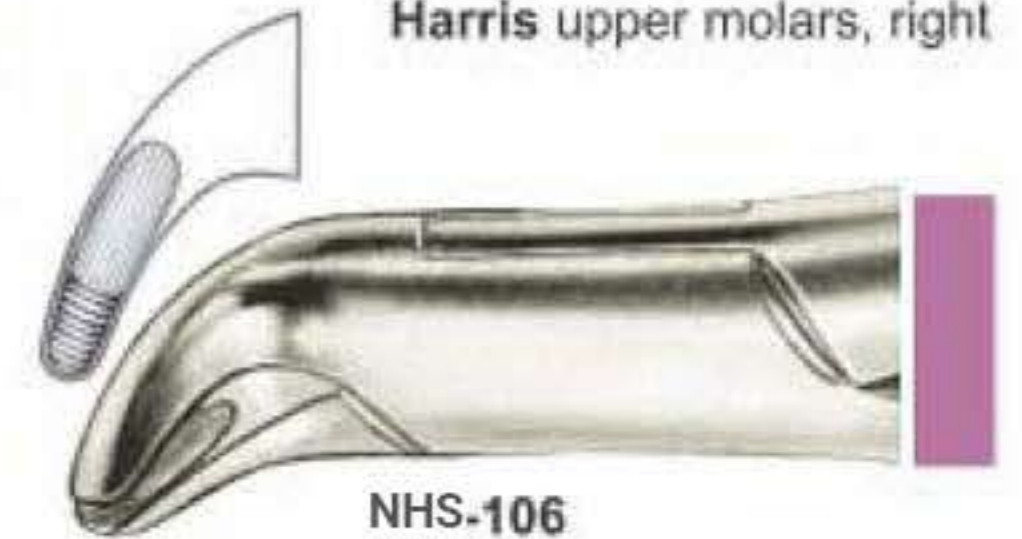

NHS-106 # 29S lower teeth, for children



NHS-107 # 35 upper roots



NHS-108 Cohen universal forceps

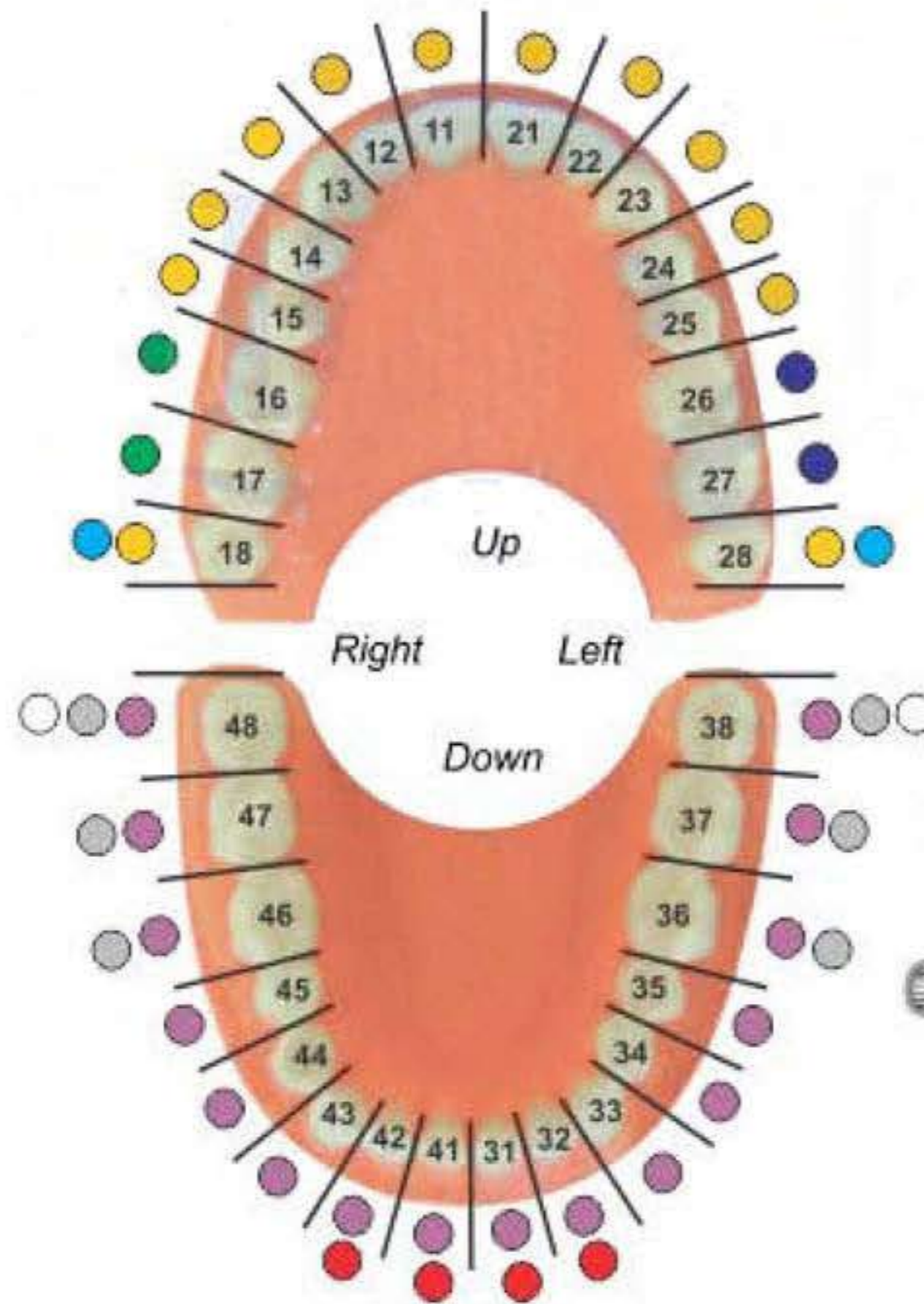



## EXTRACTING FORCEPS (American Pattern)

- Щипцы экстракционные (американская форма)
- Daviers - forme américaine
- Férceps de extracción - forma americana
- Щипці екстракційні (американська форма)
- Pinzere per estrazione - forma americana
- استخراج الملقط (النمط الأمريكي)



NHS-109  
Fig. 1  
Upper Anterior

NHS-110  
Lower Molar  
Fig. 23 Cow Horn



NHS-111  
Fig. 74  
Lower Anterior



NHS-112  
Fig. 88L  
Upper Molar Left



NHS-113  
Fig. 88R  
Upper Molar Right



NHS-114  
Fig. 74  
Lower Anterior



NHS-115  
Fig. 106  
Lower Incisors



NHS-116  
Fig. 174  
Extra Narrow  
Lower Anterior  
Apical Retention  
Forceps



NHS-117  
Fig. 859  
Lower Molars  
Roots







## DENTAL SYRINGES

- Шприцы стоматологические карпульные
- Seringues à usage dentaire
- Dentspritzen

- Шприці стоматологічні карпульні
- Jeringas dentales
- المحاقن الأسنان

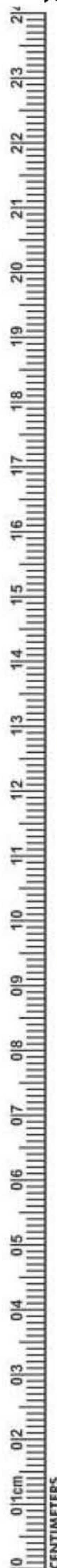

NHS-118 1.8ML  
NHS-119 2.2ML



NHS-120 1.8ML  
NHS-121 2.2ML



NHS-122 1.8ML  
NHS-123 2.2ML



NHS-124 1.8ML  
NHS-125 2.2ML



NHS-126 1.8ML  
NHS-127 2.2ML



NHS-128 1.8ML  
NHS-129 2.2ML



NHS-130  
# 1001  
Intraligamental  
Anesthesia Syringe  
in Black Colour



NHS-131 1.8ML  
NHS-132 2.2ML  
Angled



NHS-133  
Aluminium



NHS-134  
Aluminium - Silver 1.8 ml



NHS-135  
Aluminium - Orange 1.8 ml



NHS-136  
Aluminium - Green 1.8 ml



NHS-137  
Aluminium - Blue 1.8 ml



# BONE ROUNGER

- Костные кусачки
- Hohlmeißelzangen
- Pincès-gouges
- Кусачки для кісток
- Pinzas-gubias
- رونچپورس العظام



**NHS-138**  
Blumenthal  
15cm



**NHS-139**  
Blumenthal  
15cm



**NHS-140**  
Blumenthal  
15cm



**NHS-141**  
Friedman  
14cm



**NHS-142**  
Friedman  
14.5cm



**NHS-143**  
Micro-Friedman  
14cm



**NHS-144**  
Micro-Friedman  
15cm



**NHS-145**  
Micro-Friedman  
16cm



**NHS-146**  
Kleinert-Kutz  
18.5cm



**NHS-147**  
Beyer  
18.5cm



**NHS-148**  
Mead 1A  
18.5cm



**NHS-149**  
Luer  
18.5cm







**NAZEERIYA  
HAROONIYA**  
Surgical Industries

# ROOT ELEVATORS

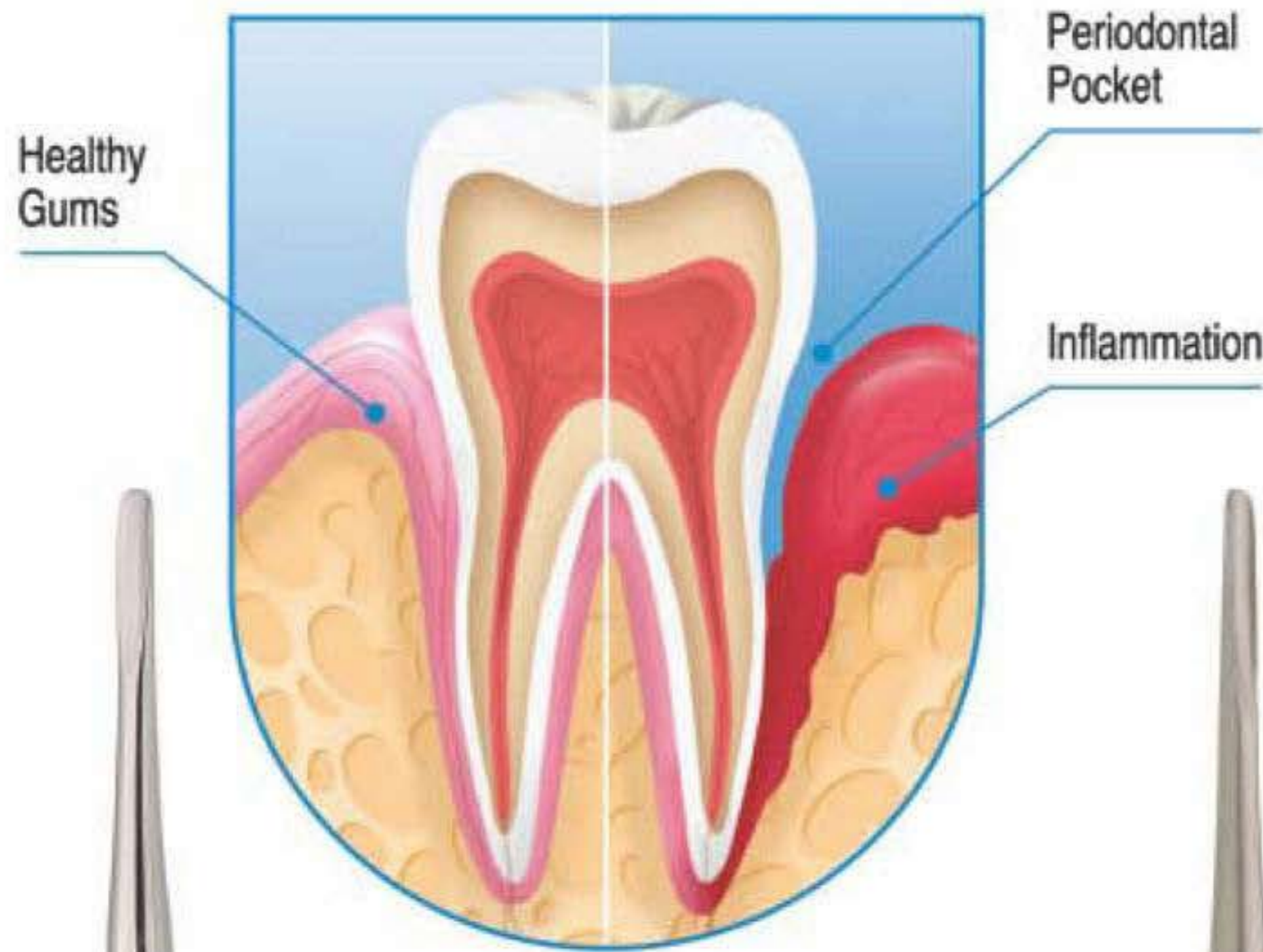
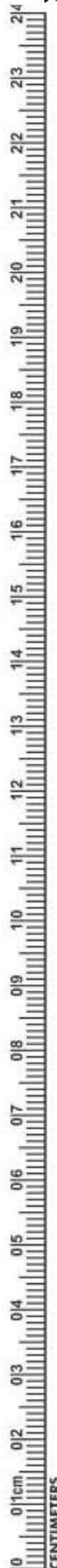

**HANDLES FOR ROOT ELEVATORS POINTS  
A, B, C, D**

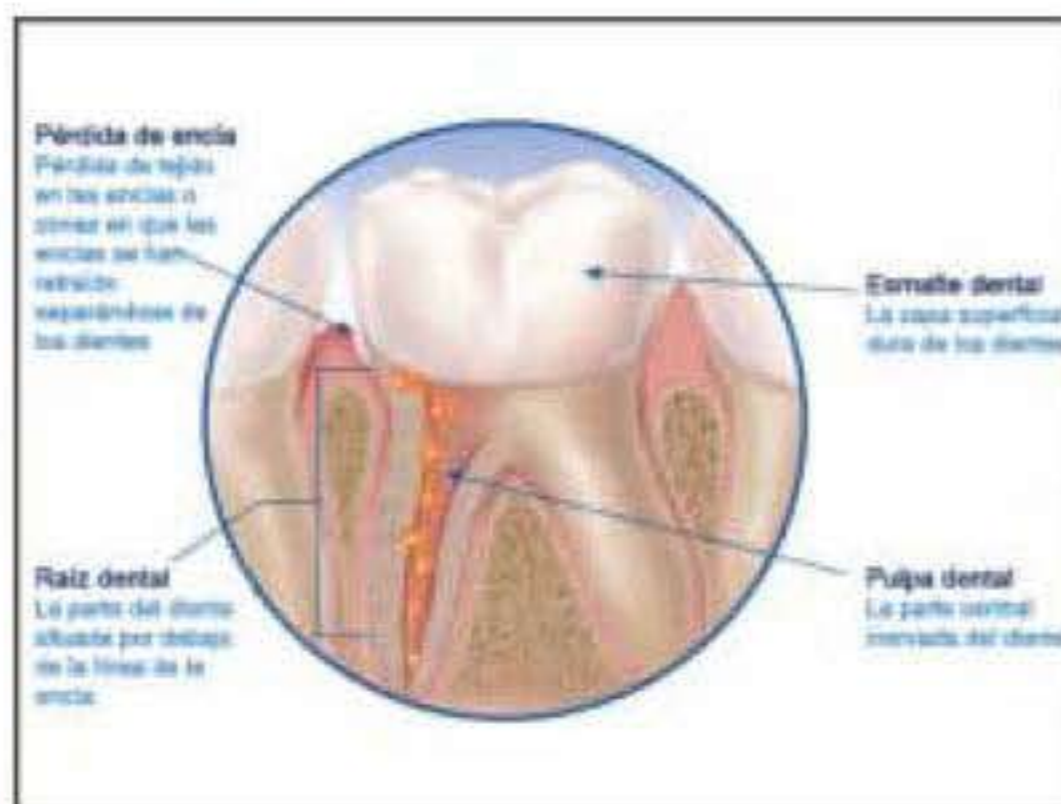



# ROOT ELEVATOR

- Элеватор корневой экстракционный
- Elévateurs à racines
- Wurzelheber
- Elevator corneviy ekstraktsionnyy
- Elevadores para raices
- المصاعد الجذر

## Apexo Root Elevators



Apexo



**NHS-150**  
Apexo  
2.5x9mm  
Straight



**NHS-151**  
Apexo  
2.7x9mm  
Straight



**NHS-152**  
Apexo  
3.0x9mm  
Straight



**NHS-153**  
Apexo  
2.5x9mm  
Curved



**NHS-154**  
Apexo  
3.0x9mm  
Curved



**NHS-155**  
Seldin  
3.0x14mm  
Straight

## Luxator Root Elevators



Luxator



**NHS-156**  
Luxator  
3mm  
straight



**NHS-157**  
Luxator  
3mm  
curved



**NHS-158**  
Luxator  
4mm  
straight



**NHS-159**  
Luxator  
4mm  
curved



**NHS-160**  
Luxator  
5mm  
straight



**NHS-161**  
Luxator  
5mm  
curved

## Bein Root Elevators



Bein



**NHS-162**  
Bein 2mm



**NHS-163**  
Bein 3mm



**NHS-164**  
Bein 4mm

## Seldin Root Elevators



Seldin



**NHS-165**  
Flohr 1



**NHS-166**  
Seldin 34S



**NHS-167**  
Seldin 34





- Элеватор корневой экстракционный
- Elévateurs à racines
- Wurzelheber
- Elevator corneviy ekstraktsionnyy
- Elevadores para raices
- المصاعد الجذر

## Apexo Root Elevators



Apexo



NHS-168  
Apexo  
2.5x9mm  
Straight



NHS-169  
Apexo  
2.7x9mm  
Straight



NHS-170  
Apexo  
3.0x9mm  
Straight



NHS-171  
Apexo  
2.5x9mm  
Curved



NHS-172  
Apexo  
3.0x9mm  
Curved



NHS-173  
Seldin  
3.0x14mm  
Straight

## Luxator Root Elevators



Luxator



NHS-174  
Luxator  
3mm  
straight



NHS-175  
Luxator  
3mm  
curved



NHS-176  
Luxator  
4mm  
straight



NHS-177  
Luxator  
4mm  
curved



NHS-178  
Luxator  
5mm  
straight



NHS-179  
Luxator  
5mm  
curved

## Bein Root Elevators



Bein



NHS-180  
Bein 2mm



NHS-181  
Bein 3mm



NHS-182  
Bein 4mm

## Seldin Root Elevators



Seldin



NHS-183  
Flohr 1



NHS-184  
Seldin 34S



NHS-185  
Seldin 34

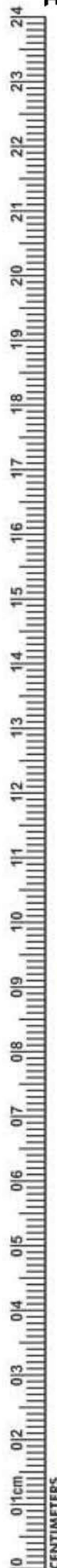



# ROOT ELEVATOR

- Элеватор корневой экстракционный
- Elevateurs à racines
- Wurzelheber
- Elevator corneviy ekstraktsionniy
- Elevadores para raices
- المصاعد الجذر

## Apical Root Elevators

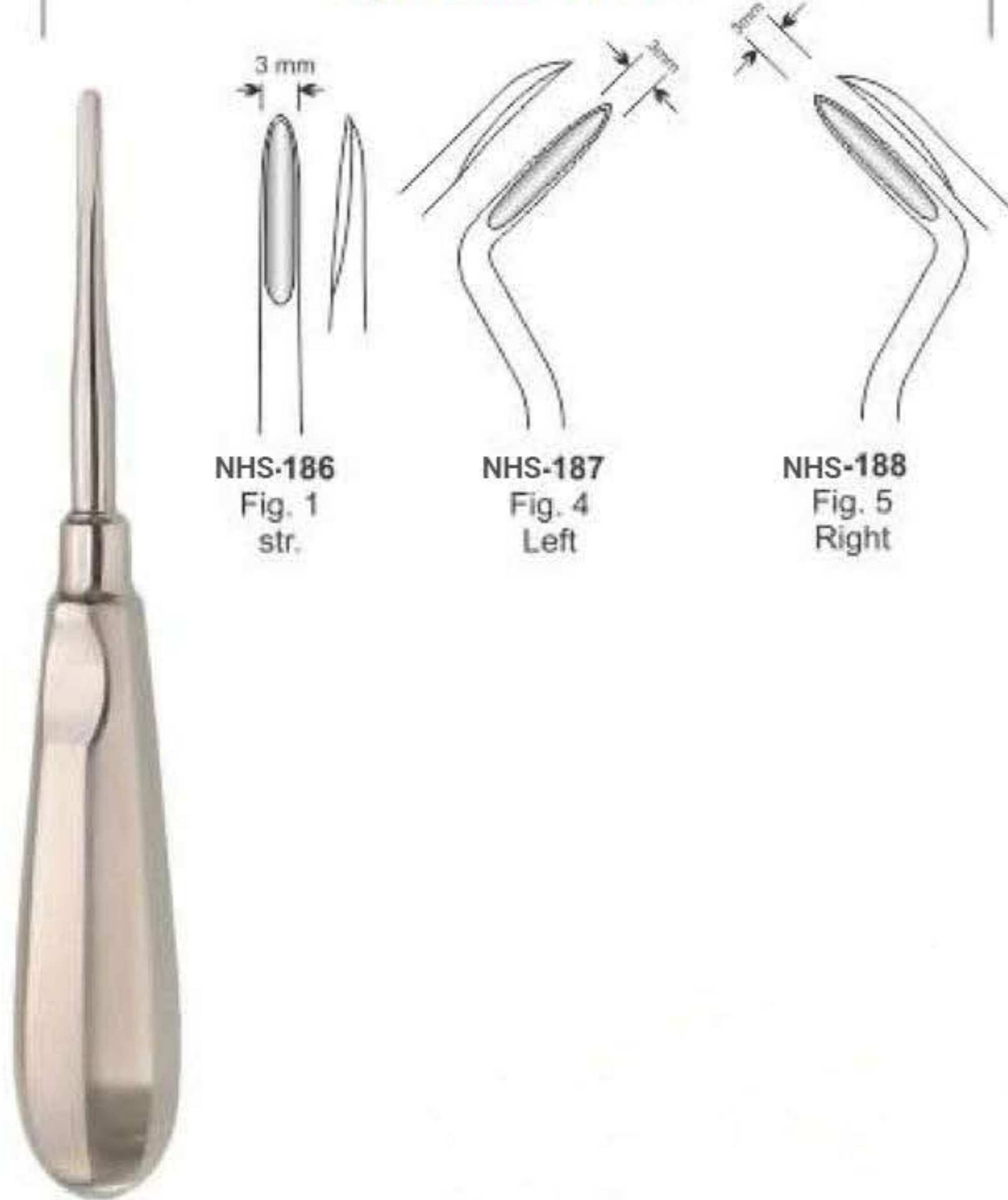

## Apical Root Elevators

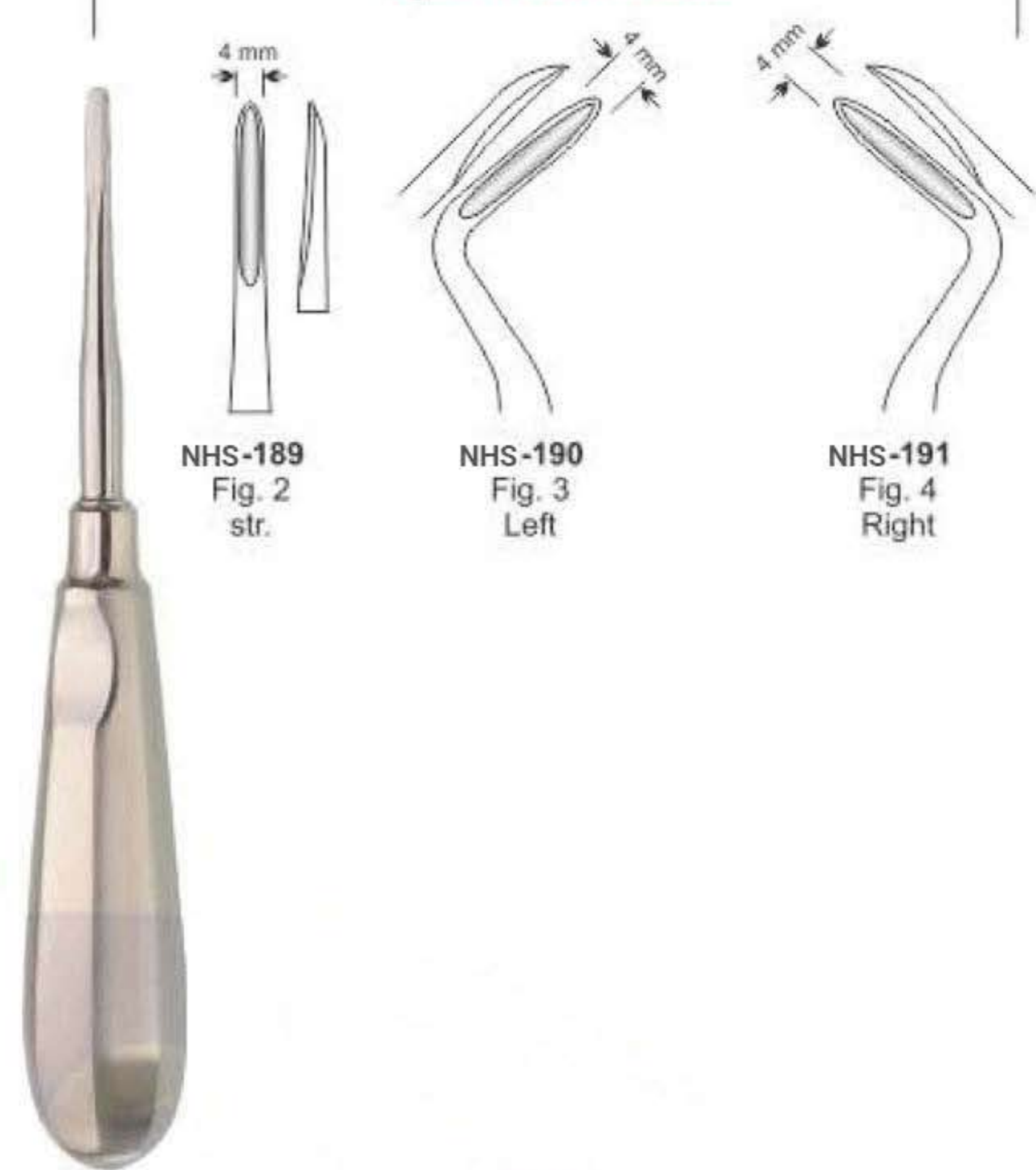

## Coupland Root Elevators

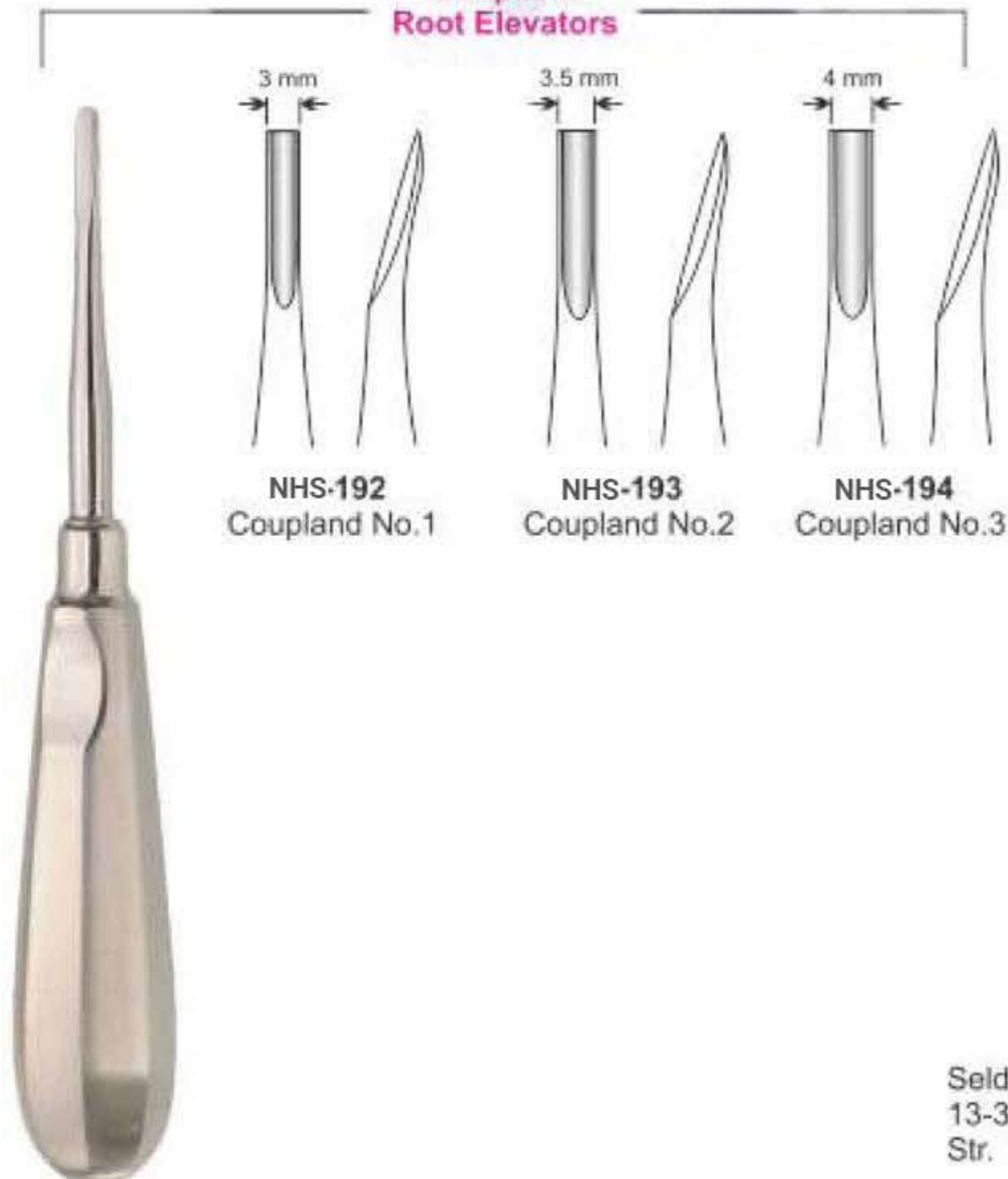

## Seldin Root Elevators

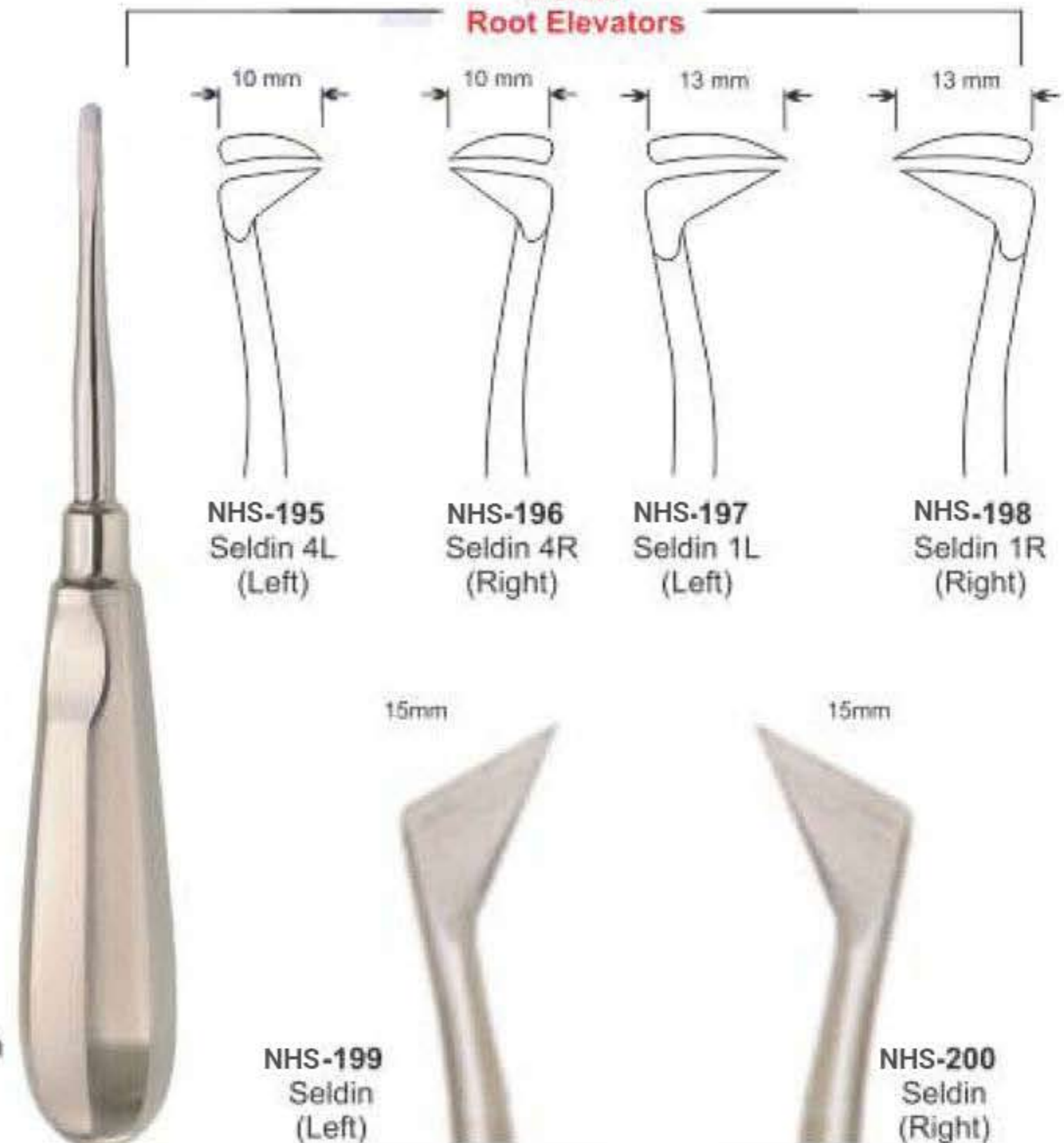



- Элеватор корневой экстракционный
- Elevateurs à racines
- Wurzelheber

- Elevator cornevia ekstraktsionnyy
- Elevadores para raices
- المعساعد الجذر

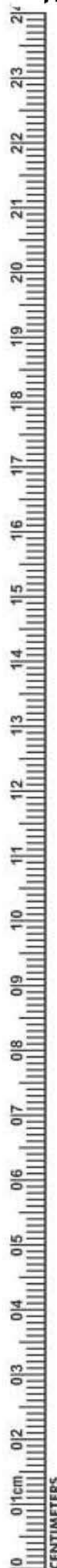

**Apical Root Elevators**

**Apical Root Elevators**



NHS-201  
Fig. 1  
Str.

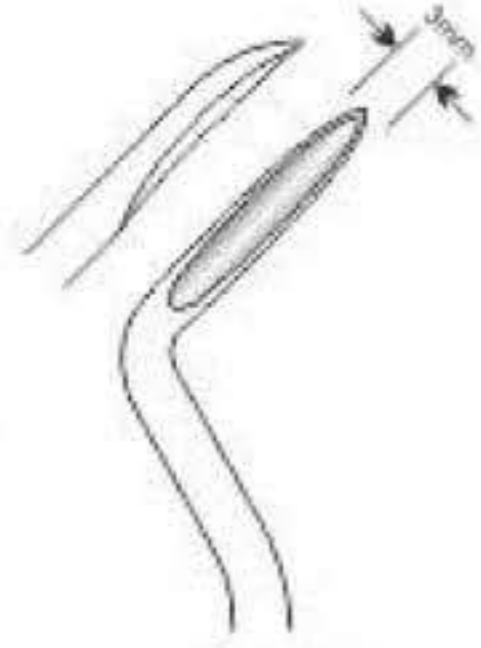

NHS-202  
Fig. 4  
Left

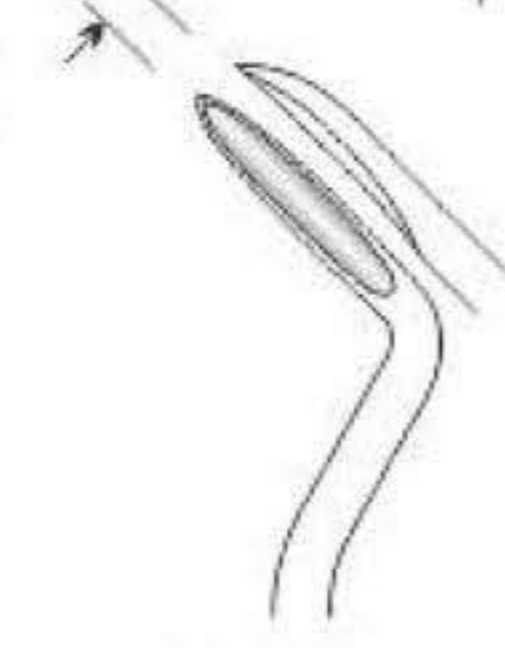

NHS-203  
Fig. 5  
Right



NHS-204  
Fig. 2  
Str.



NHS-205  
Fig. 3  
Left

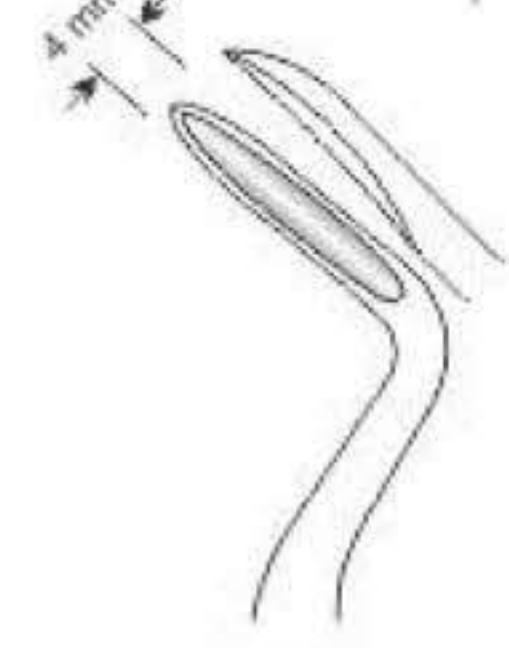

NHS-206  
Fig. 4  
Right

**Coupland Root Elevators**

**Seldin Root Elevators**



NHS-207  
Coupland No.1



NHS-208  
Coupland No.2



NHS-209  
Coupland No.3

Coupland



NHS-210  
Seldin 4L  
(Left)



NHS-211  
Seldin 4R  
(Right)

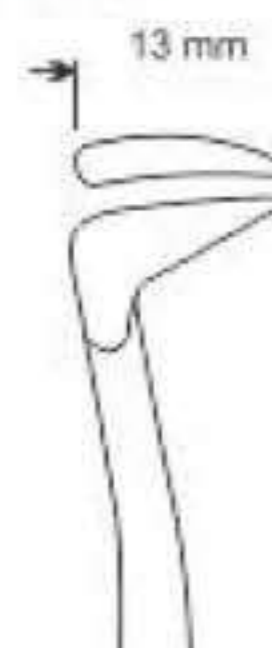

NHS-212  
Seldin 1L  
(Left)



NHS-213  
Seldin 1R  
(Right)

Seldin  
13-3  
Str.



NHS-2  
Seld  
(Lef



NHS-215  
Seldin  
(Right)



# ROOT ELEVATOR

- Элеватор корневой экстракционный
- Elevateurs à racines
- Wurzelheber
- Elevator corneviy ekstraktsionniy
- Elevadores para raices
- المصاعد الجذر

## Apical Root Elevators

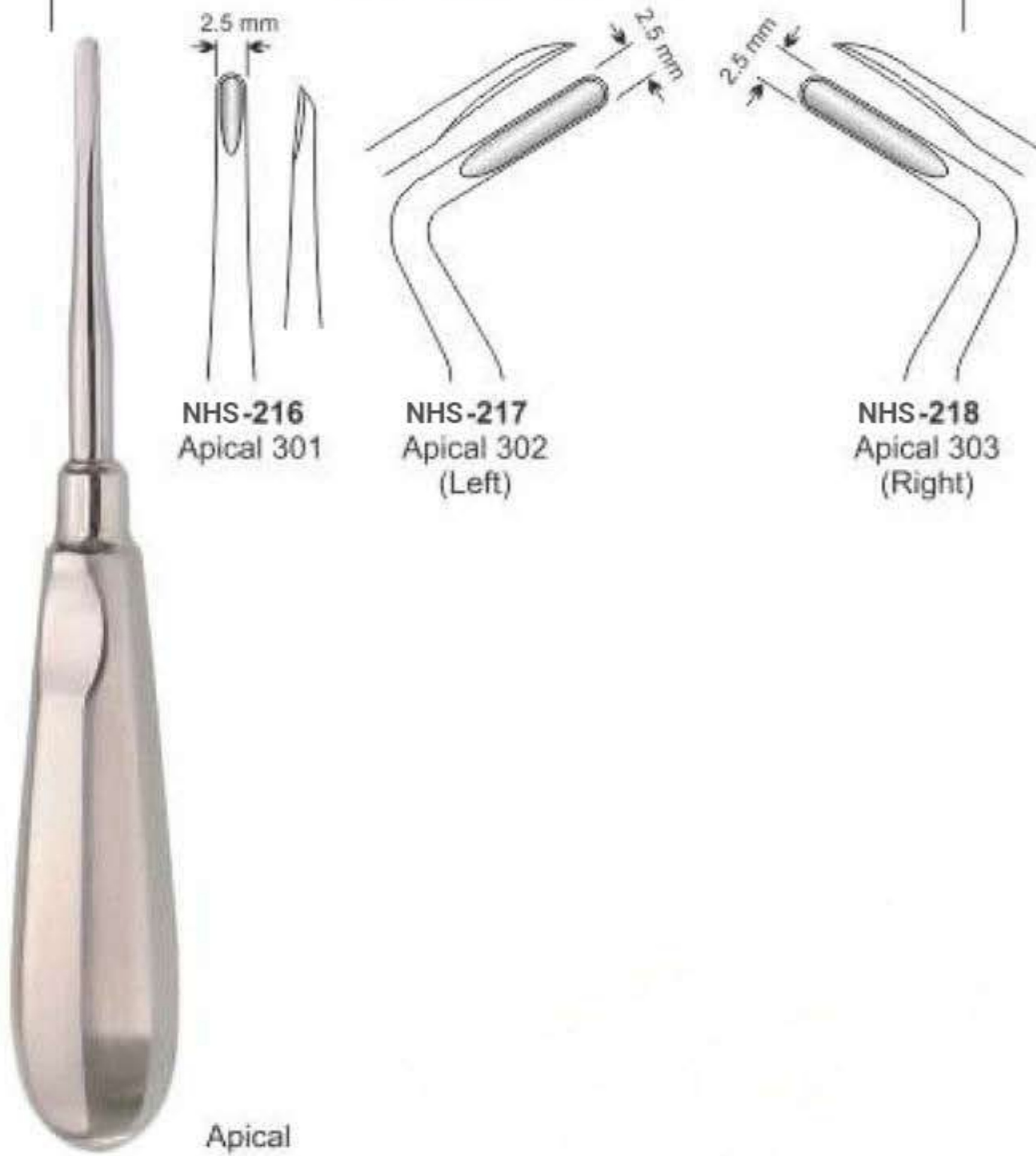

## Apical Root Elevators



## Apical Root Elevators



## Laxutor Root Elevators

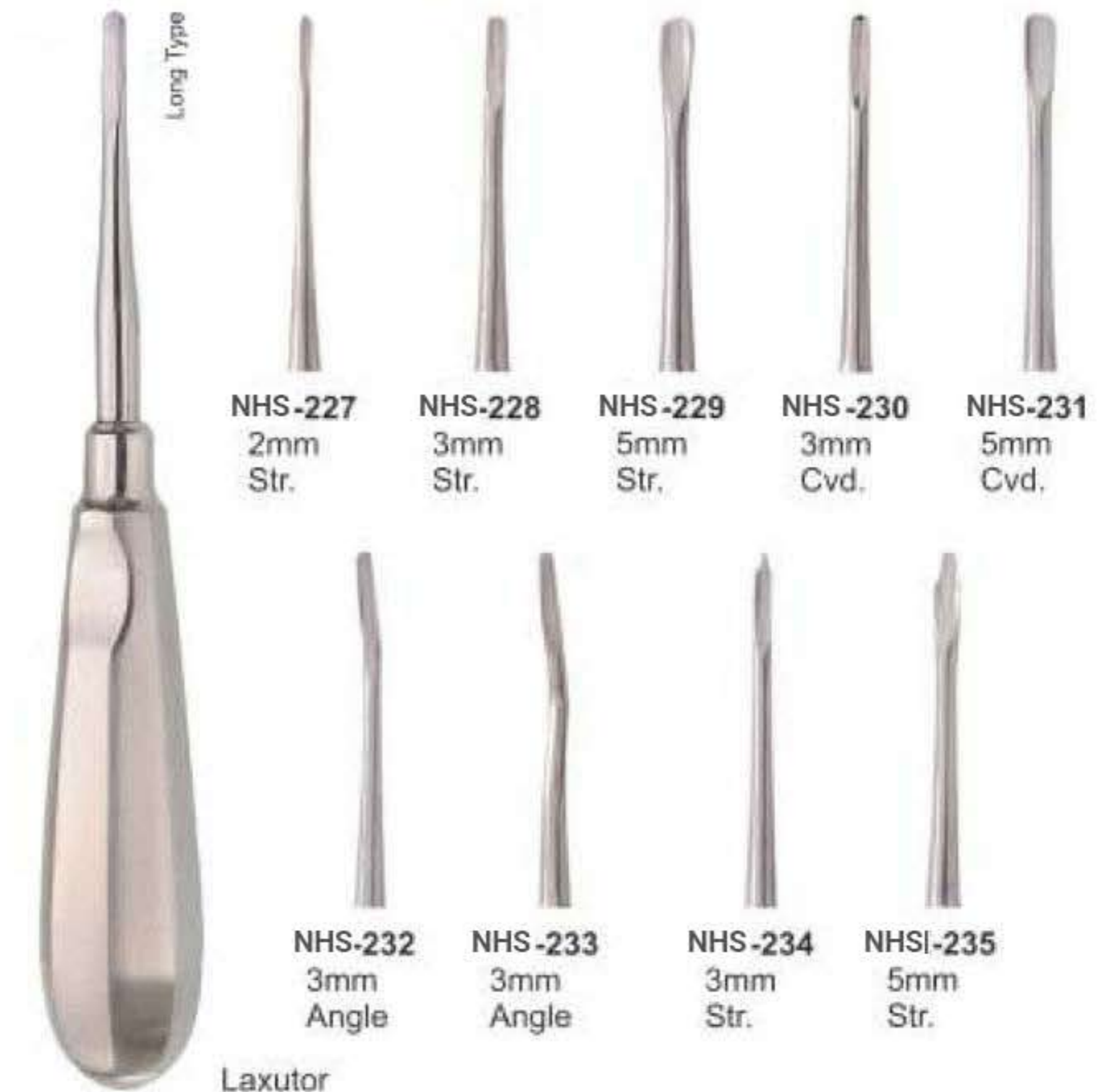





- Элеватор корневой экстракционный
- Elévateurs à racines
- Wurzelheber
- Elevator corneviu extracționii
- Elevadores para raices
- المصاعد الجذر

### Lindo Levian Root Elevators

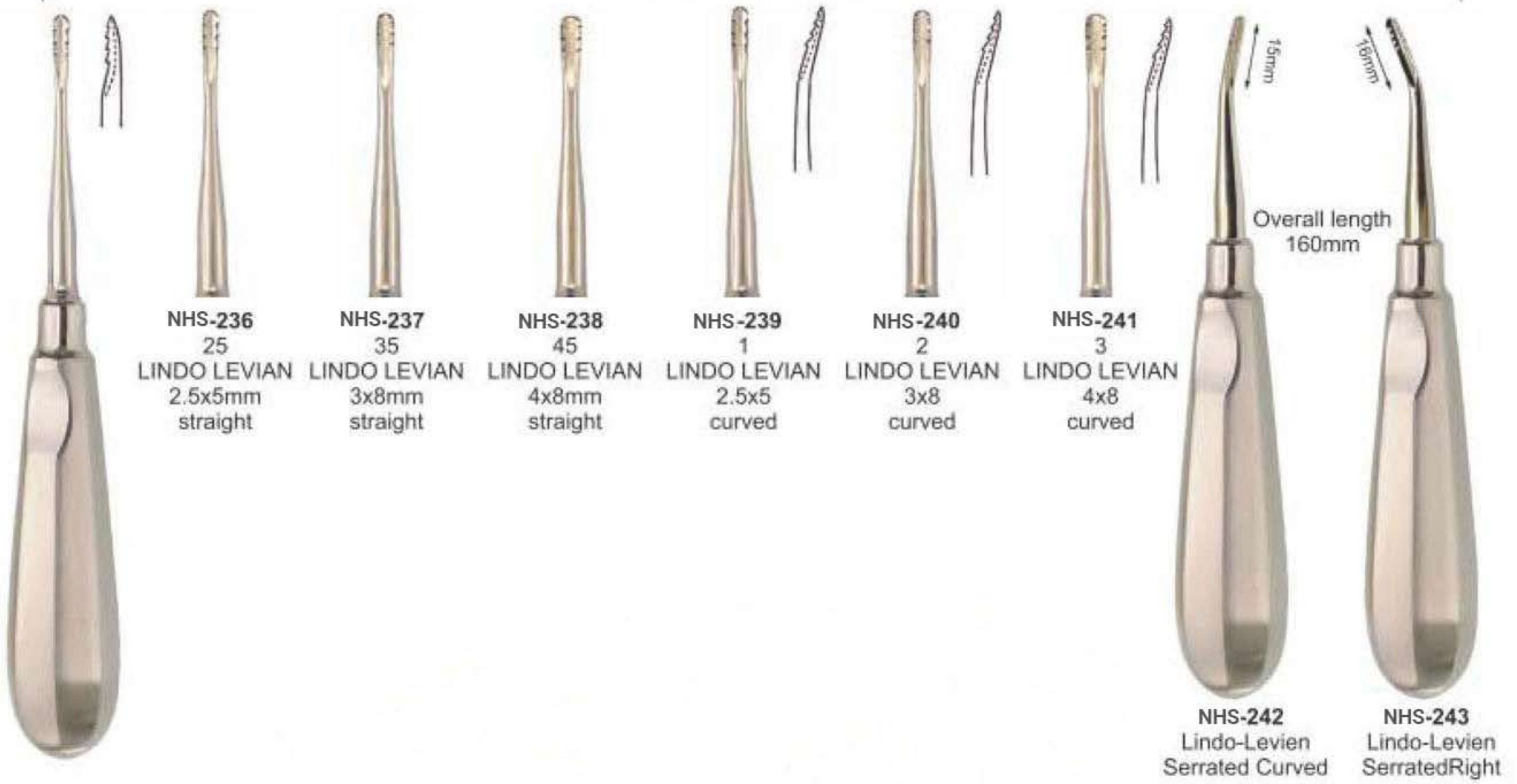

### Flohr Root Elevators

### Heidbrink Root Elevators

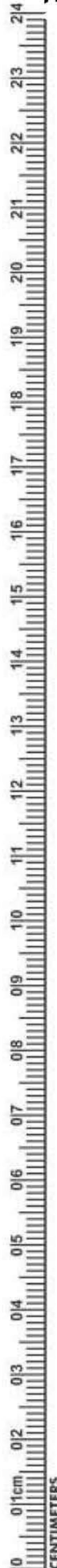
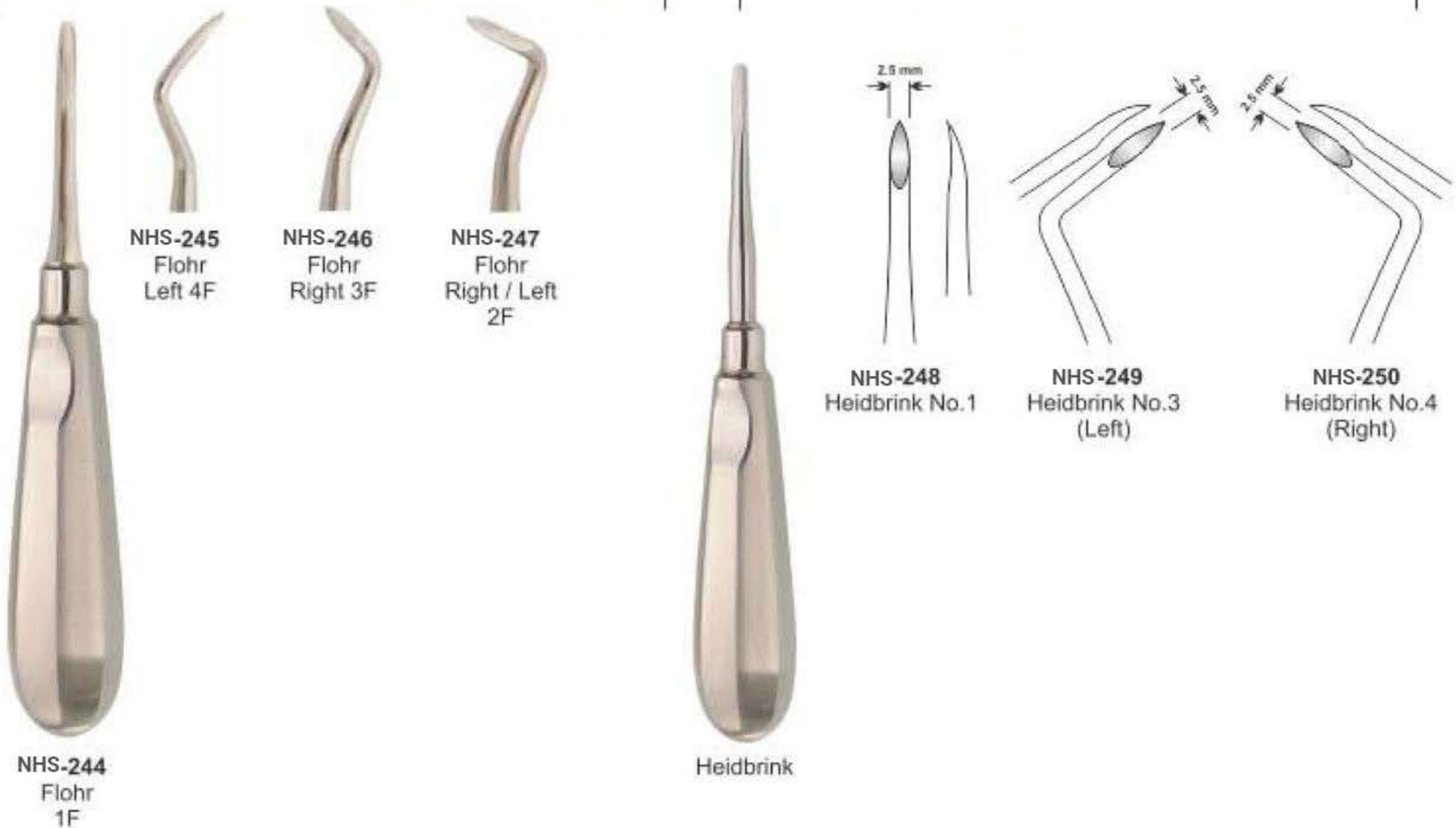



# ROOT ELEVATOR

- Элеватор корневой экстракционный
- Elévateurs à racines
- Wurzelheber
- Elevator corneviu extracționii
- Elevadores para raices
- المصاعد الجذر

## Friedmann Roots Elevator



NHS-251  
Friedmann 4F  
Str.

NHS-252  
Friedmann 5F  
Left

NHS-253  
Friedmann 6F  
Right

## Heidbrink Roots Elevator



NHS-254  
Heidbrink  
Straight

NHS-255  
Heidbrink  
Left

NHS-256  
Heidbrink  
Right

## Wisdom Roots Elevator



NHS-257  
Wisdom  
for 18 and 38

NHS-258  
Wisdom  
for 28 and 48

## Bayonet Roots Elevator Set



NHS-259  
Left

NHS-260  
Right

NHS-261  
bayonet

NHS-262  
Curved

NHS-263  
Straight

## Luxator Roots Elevator



NHS-264  
Luxator  
Straight

NHS-265  
Luxator  
Curved







# ROOT ELEVATOR

- Элеватор корневой экстракционный
- Elévateurs à racines
- Wurzelheber
- Elevator corneviy ekstraktsionnyy
- Elevadores para raices
- المعصاعد الجذر

## Roots Elevator

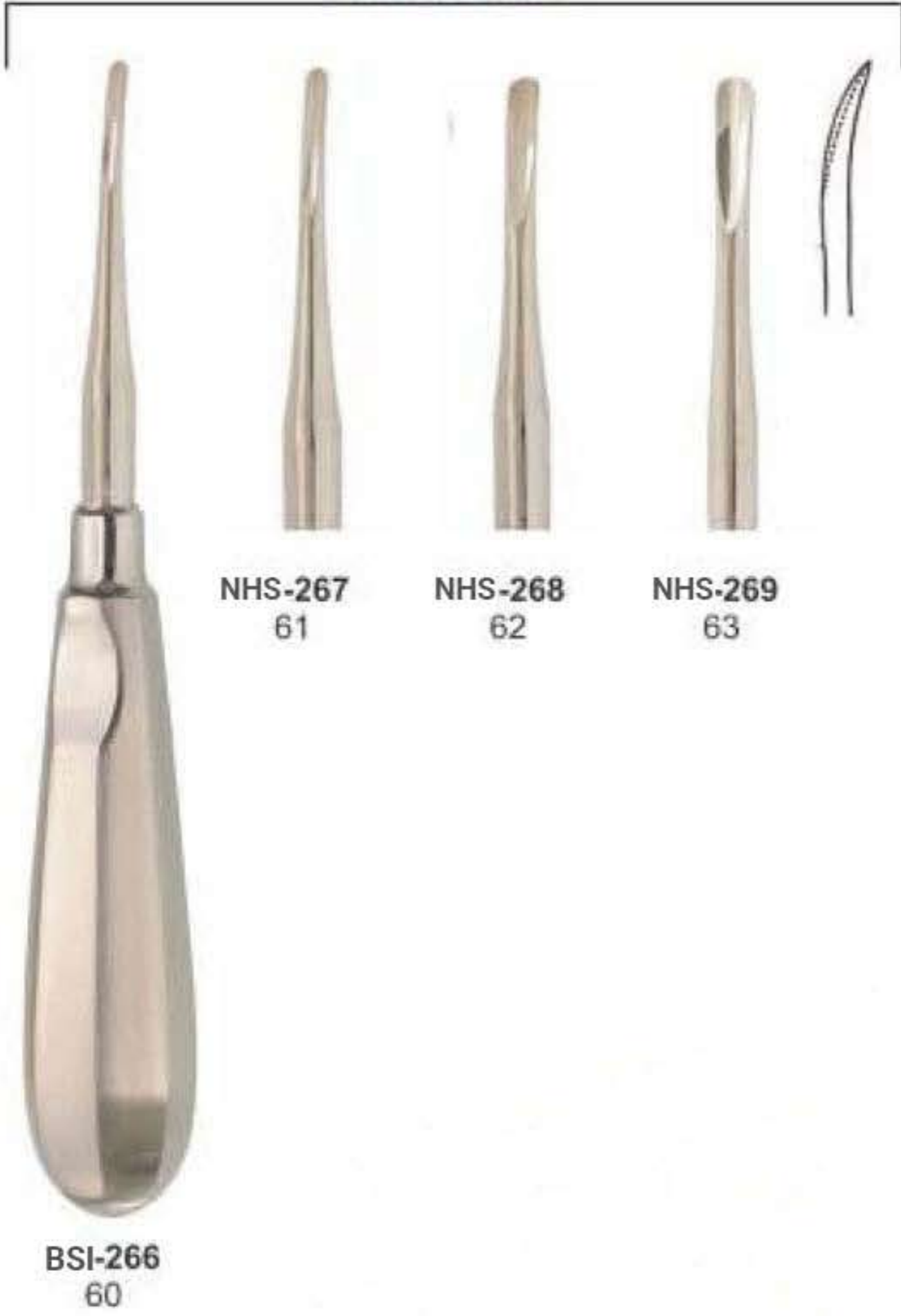

## Luxier Roots Elevator



## Luxier Roots Elevator

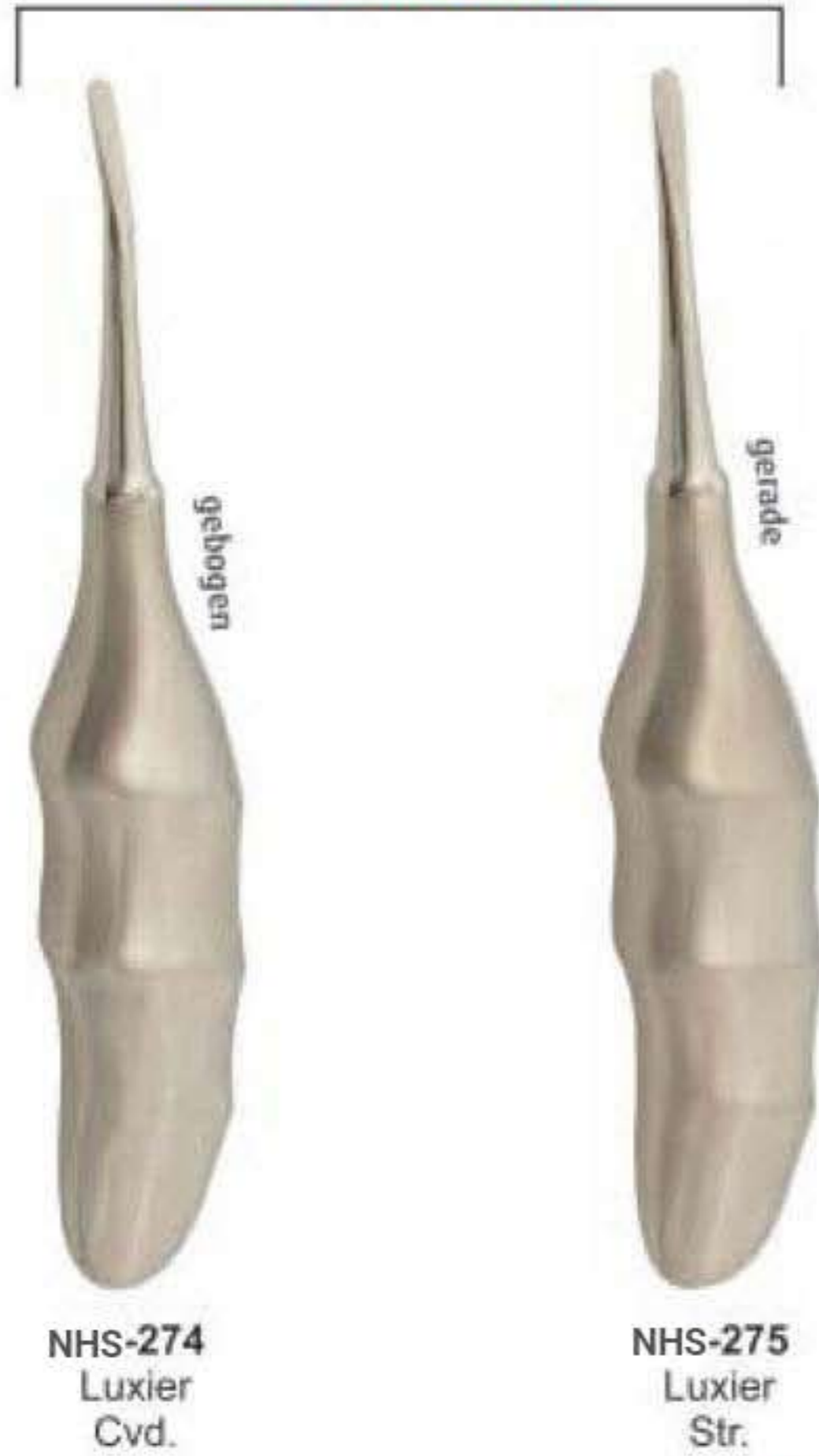

## Claw-Lift Roots Elevator

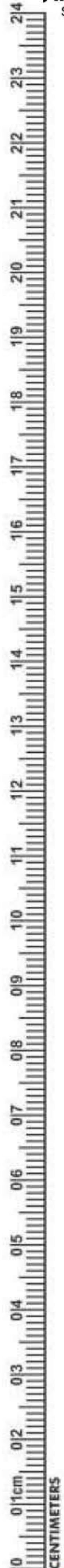



# ROOT ELEVATOR

- Elevator корневой экстракционный
- Elevateurs à racines
- Wurzelheber
- Elevator корневий екстракційний
- Elevadores para raices
- المصاعد الجذر

## Hylin Roots Elevator



## Cryer Roots Elevator



## Kopp Roots Elevator







# ROOT ELEVATOR

- Элеватор корневой экстракционный
- Elévateurs à racines
- Wurzelheber

- Elevator corneviy ekstraktsionniy
- Elevadores para raices
- المصاعد الجذر

## Kopp Roots Elevator



NHS-295  
Kopp  
Right

NHS-296  
Kopp  
Left

## Heber Roots Elevator



NHS-297  
Heber  
Bayonet

NHS-298  
Heber  
Bayonet

## Bein Roots Elevator



NHS-299  
Bein,  
3mm

NHS-300  
Bein,  
4mm

## Bein Roots Elevator

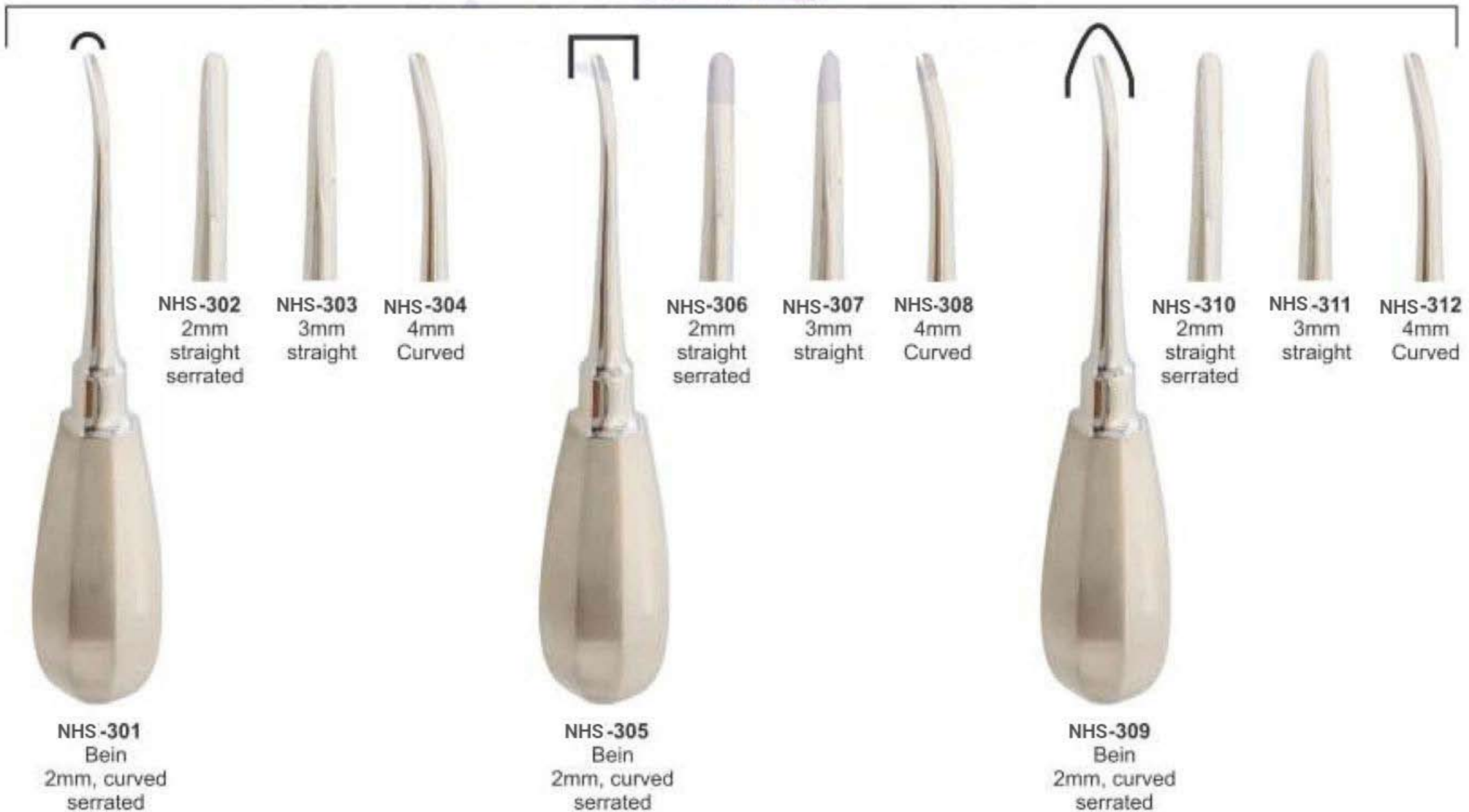

NHS-302  
2mm  
straight  
serrated

NHS-303  
3mm  
straight

NHS-304  
4mm  
Curved

NHS-306  
2mm  
straight  
serrated

NHS-307  
3mm  
straight

NHS-308  
4mm  
Curved

NHS-310  
2mm  
straight  
serrated

NHS-311  
3mm  
straight

NHS-312  
4mm  
Curved

NHS-301  
Bein  
2mm, curved  
serrated

NHS-305  
Bein  
2mm, curved  
serrated

NHS-309  
Bein  
2mm, curved  
serrated

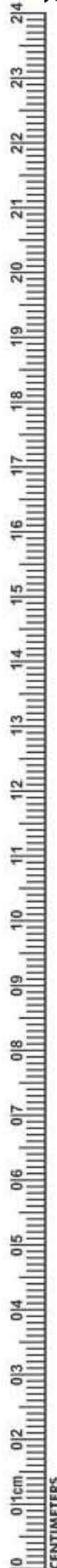



# ROOT ELEVATOR

- Элеватор корневой экстракционный
- Elévateurs à racines
- Wurzelheber
- Elevator corneviy ekstraktsionnyy
- Elevadores para raices
- المصاعد الجذر

## Seldin Roots Elevator



## W. Barry Roots Elevator



## Winter Roots Elevator



## Pott Roots Elevator







- Элеватор корневой экстракционный
- Elévateurs à racines
- Wurzelheber

- Elevator corneviu extracționii
- Elevadores para raices
- المصاعد الجذر

### Heidbrink Roots Elevator



NHS-338  
Heidbrink  
Straight

NHS-339  
Heidbrink  
Left

NHS-340  
Heidbrink  
Right

NHS-341  
Heidbrink  
Straight

NHS-342  
Heidbrink  
Left

NHS-343  
Heidbrink  
Right

### Syndesmotomes Roots Elevator



NHS-344  
Straight

NHS-345  
Left

NHS-346  
Right

### Periotome Roots Elevator



NHS-347  
Periotome  
2.1mm  
Straight

NHS-348  
Periotome  
2.6mm  
Straight

NHS-349  
Periotome  
2.1mm  
Angular

NHS-350  
Periotome  
2mm  
Curved

NHS-351  
Periotome  
2.0mm

NHS-352  
Periotome  
2.5mm

NHS-353  
Periotome  
3.0mm

NHS-354  
Periotome  
4.0mm

Syndesmotomes

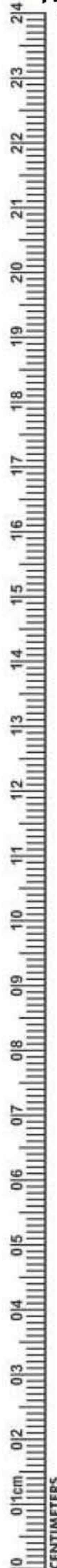





# ROOT ELEVATOR

- Элеватор корневой экстракционный
- Elevateurs à racines
- Wurzelheber
- Єлеватор коренвий екстракційний
- Elevadores para raices
- المصاعد الجذر



**NHSI-355**  
1S  
(Straight 1mm)



**NHSI-356**  
2S  
(Straight 2mm)



**NHS-357**  
3S  
(Straight 3mm)



**NHSI-358**  
5S  
(Straight 5mm)



**NHS-359**  
3C  
(Curved 3mm)



**NHS-360**  
5C  
(Curved 5mm)



**NHS-361**  
3CA  
(Curved Angle 3mm)



**NHS-362**  
3IC  
(Inverted Curved 3mm)



**NHS-363**  
DE 3  
(Dual Edge 3mm / 1.5mm)



**NHS-364**  
DE 5  
(Dual Edge 5mm / 3mm)







- Элеватор корневой экстракционный
  - Elévateurs à racines
  - Wurzelheber
- PDL ELEVATORS**

- Elevator corneviu extracționii
- Elevadores para raíces
- المعساعد الجذر

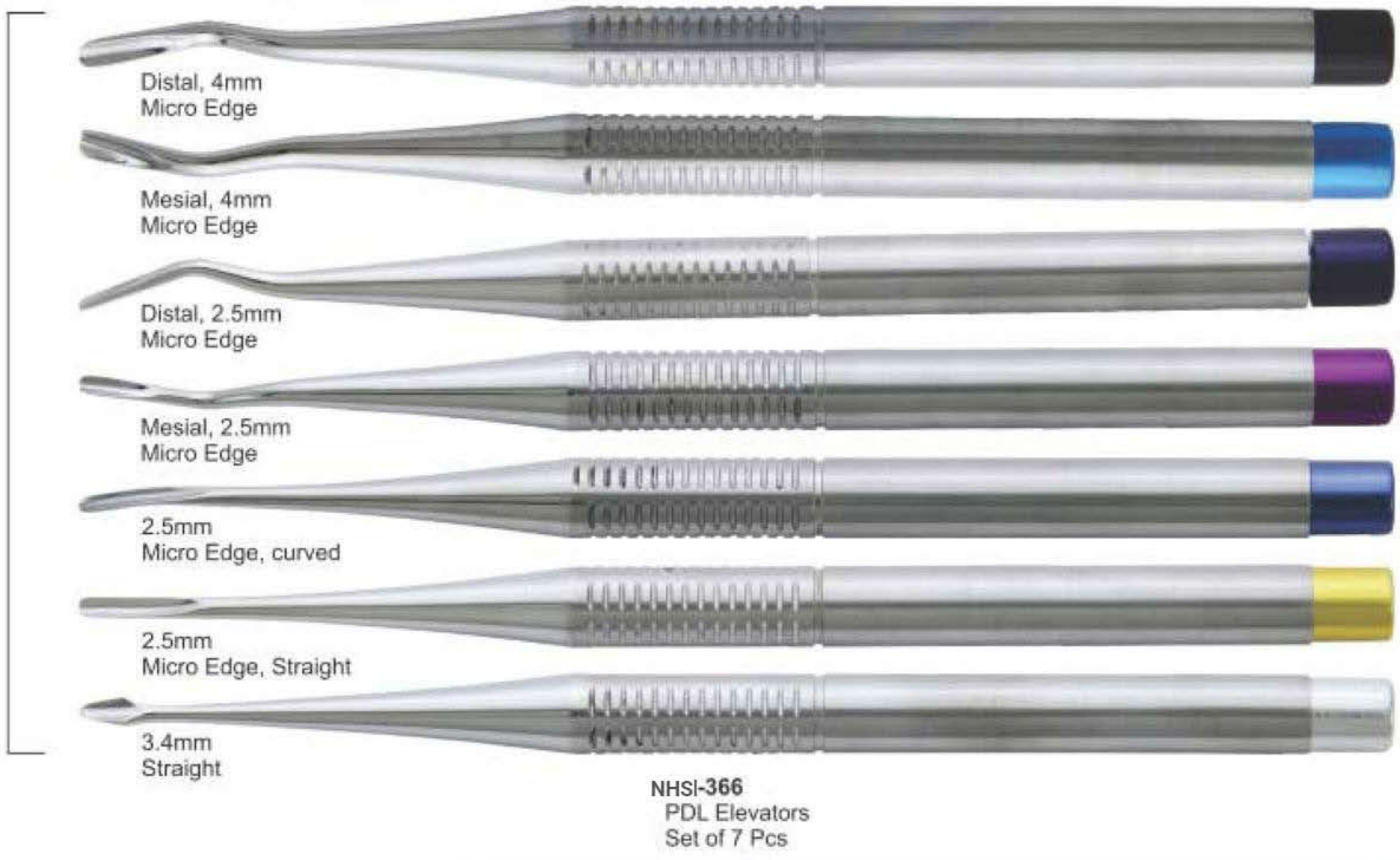
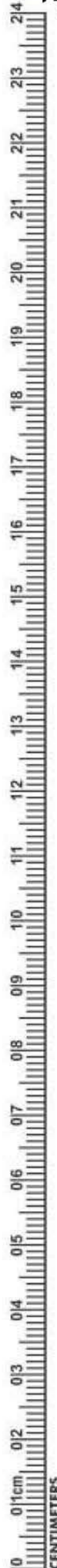



# ROOT ELEVATOR

- Элеватор корневой экстракционный
- Elévateurs à racines
- Wurzelheber
- Elevator corneviy ekstraktsionniy
- Elevadores para raices
- المصاعد الجذر

## PDL ELEVATORS

Delicate Arrow tip



4,0mm straight  
4,0mm curved

Luxivators straight  
atraumatic luxation of the tooth



2,5mm straight  
3,5mm straight  
4,5mm straight

Luxivators curved  
atraumatic luxation of the tooth



2,5mm curved  
3,5mm curved  
4,5mm curved



NHS-367  
PDL Elevators  
Set of 8 Pcs





## Our Scalers

Compare our scalers and curettes with the best in the industry and you will immediately recognize we are equal in every way but one... price. Note the deep precision knurling for better tactile feel. The same high-grade stainless steel tips, the same light weight (under 18 grams) for less hand fatigue, the same professional craftsmanship, and surpassing the highest industry standards. Of course, any manufacturer can make these claims, but we guarantee and certify ours.

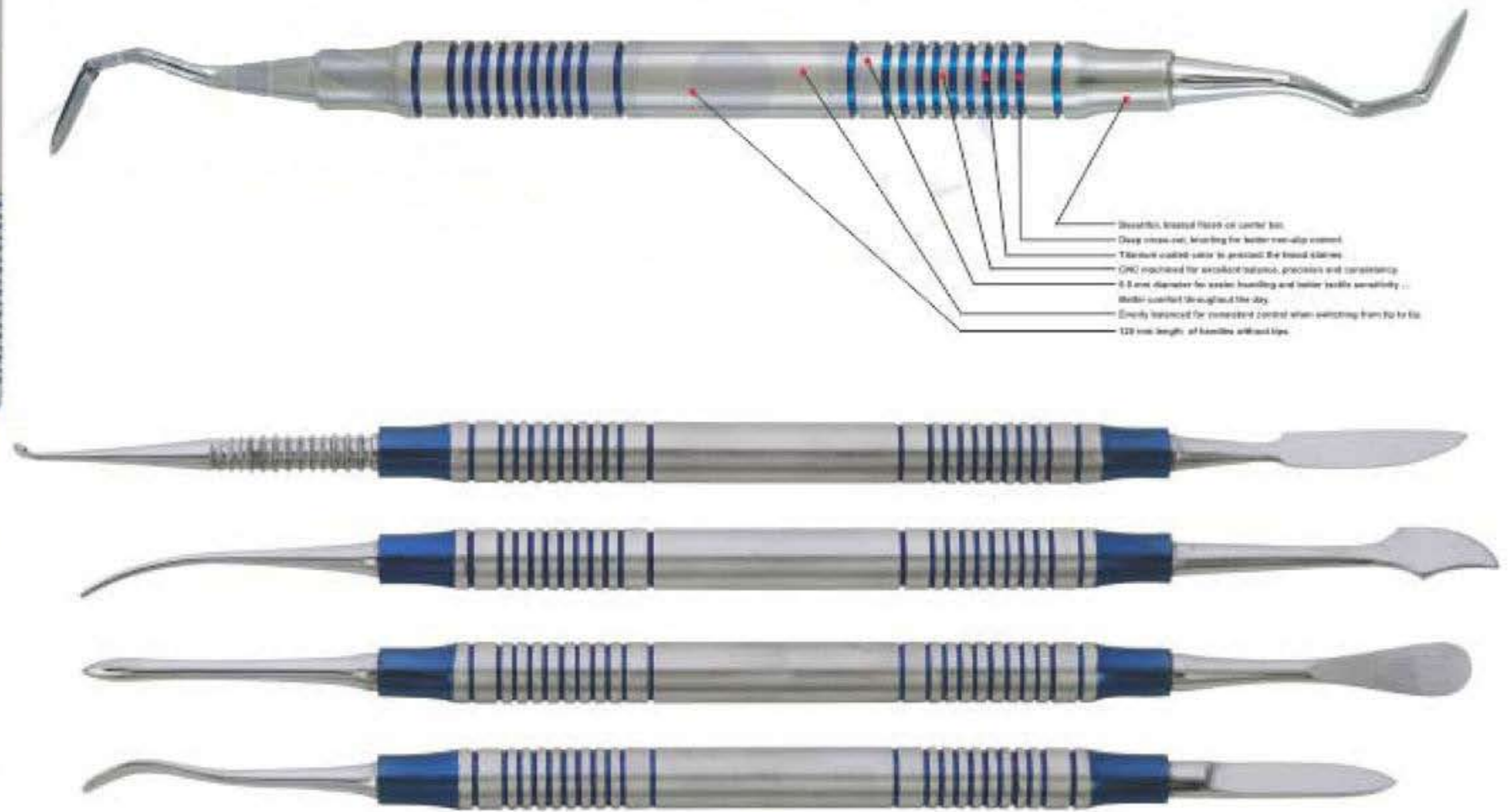
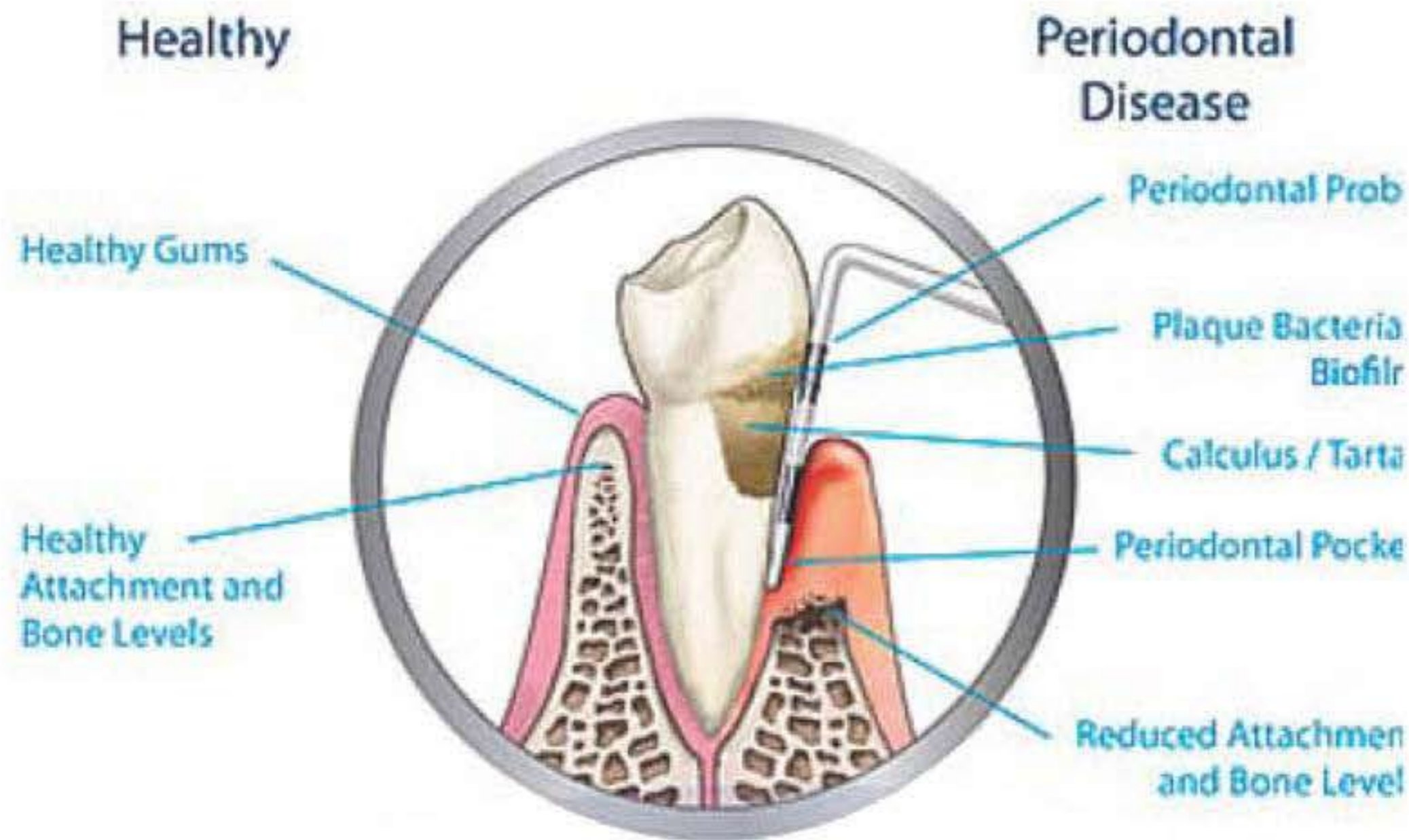
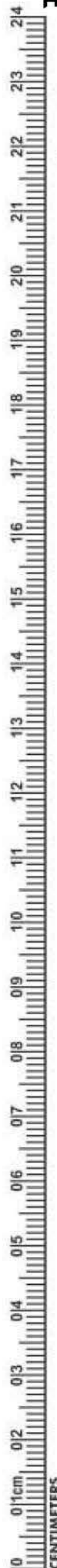

- Smooth, beveled flange on control bar
- Deep knurling, knurling for better tactile control
- Titanium coated base to protect the hand during use
- CNC machined for excellent balance, precision and consistency
- 8.5mm diameter for easier handling and better tactile sensitivity ...
- Mirror polished throughout the day
- Evenly balanced for consistent control when switching from top to tip
- 120mm length of handle without tips

- High-polish mirror finish tips.
- Manufactured within the guidelines of the FDA quality assurance system for good manufacturing practices.
- Highest grade German stainless steel, razor sharp, durable tips. Rockwell hardened to 60 RHC.
- 27 of the most popular designs from Graceys to McCalls to Columbias, and many European patterns.
- All instruments are guaranteed against defects in material and workmanship.

- All instruments bear the CE mark, emblematic of the European community's highest standards.
- Customer satisfaction guarantee, too!
- Less than 20 grams ... Lightweight for less hand fatigue.
- Manufactured to the most exacting standards so the 50th instrument you buy is exactly like your first.
- You decide ... Why pay more for the same high-quality instruments?



# HANDLES FOR MOUTH MIRRORS

- Ручки для зеркал
- Manches pour miroirs à bouche
- Mundspiegelgriffe
- Ручки для дзеркал
- Mangos para espejos de boca
- مقابض لمرآة الفم



Magnifying

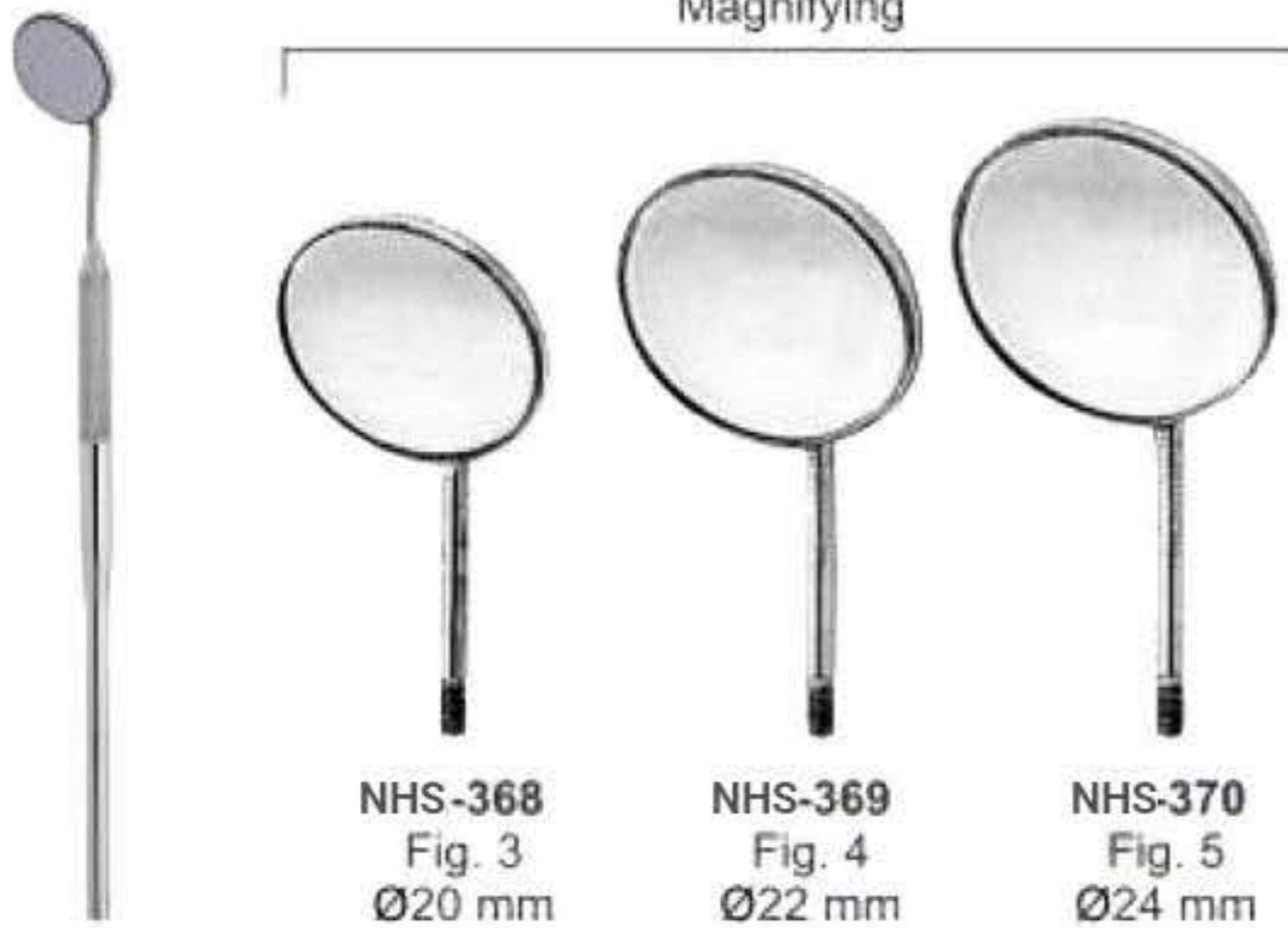

Plain

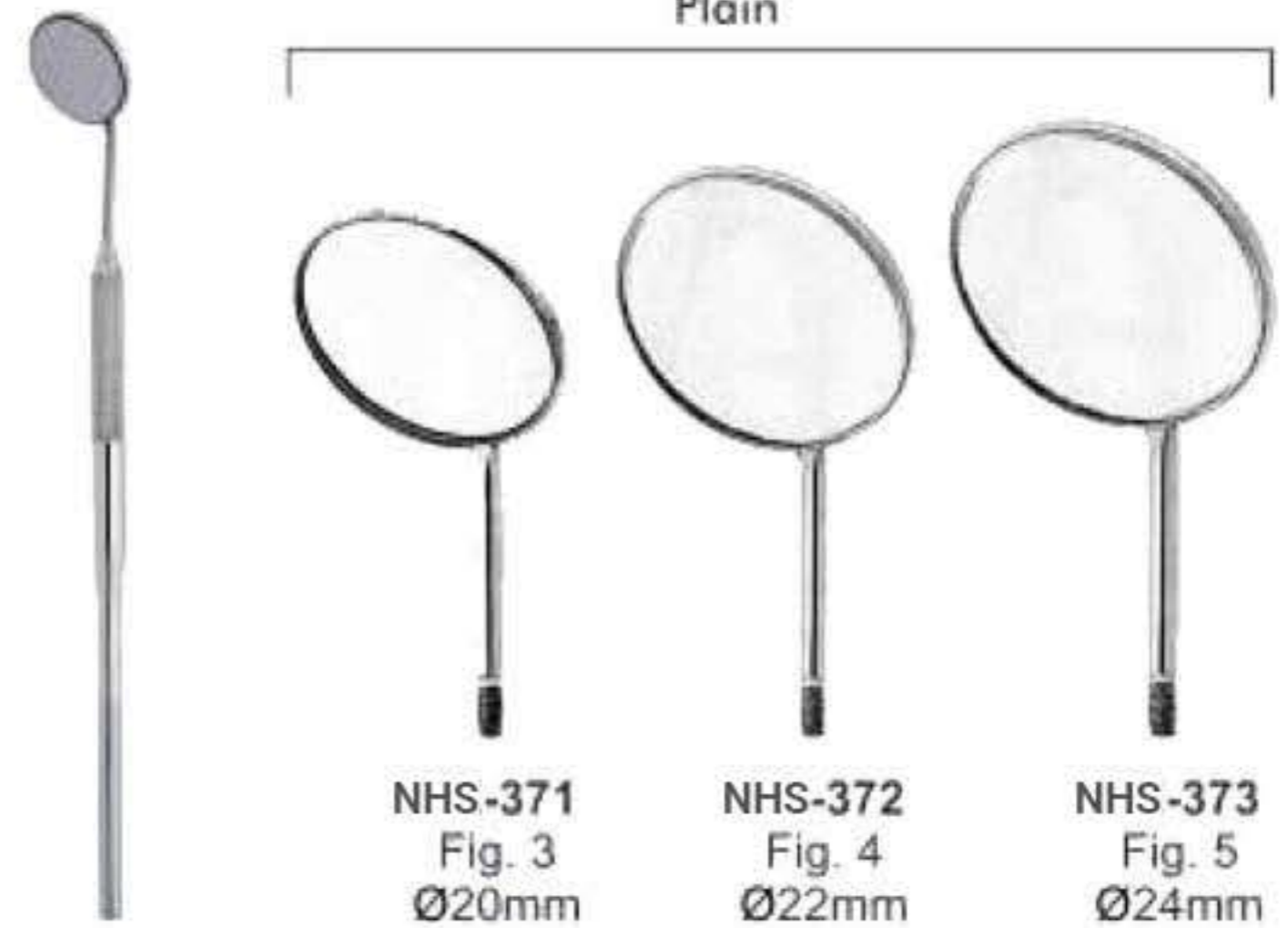

Rhodium

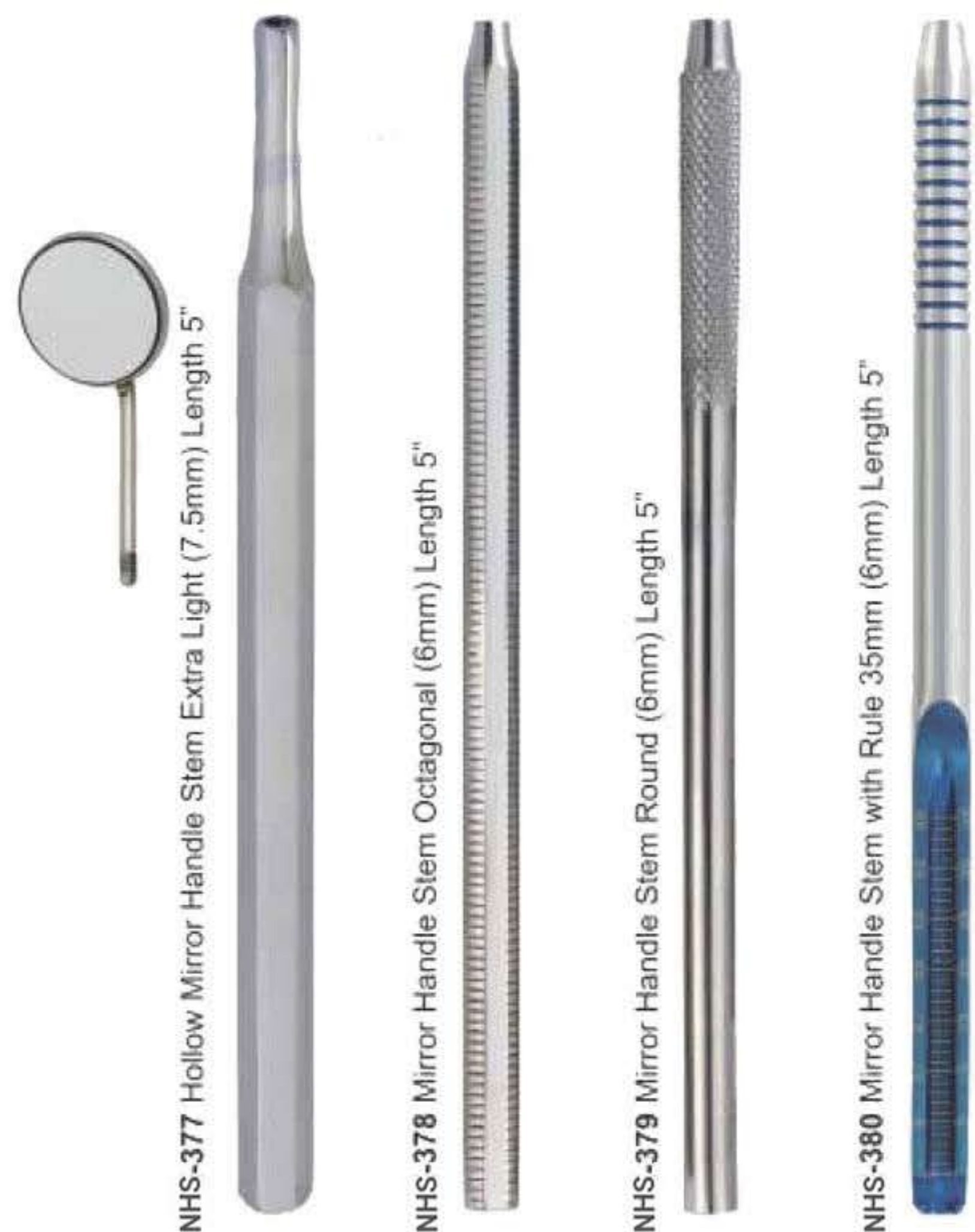
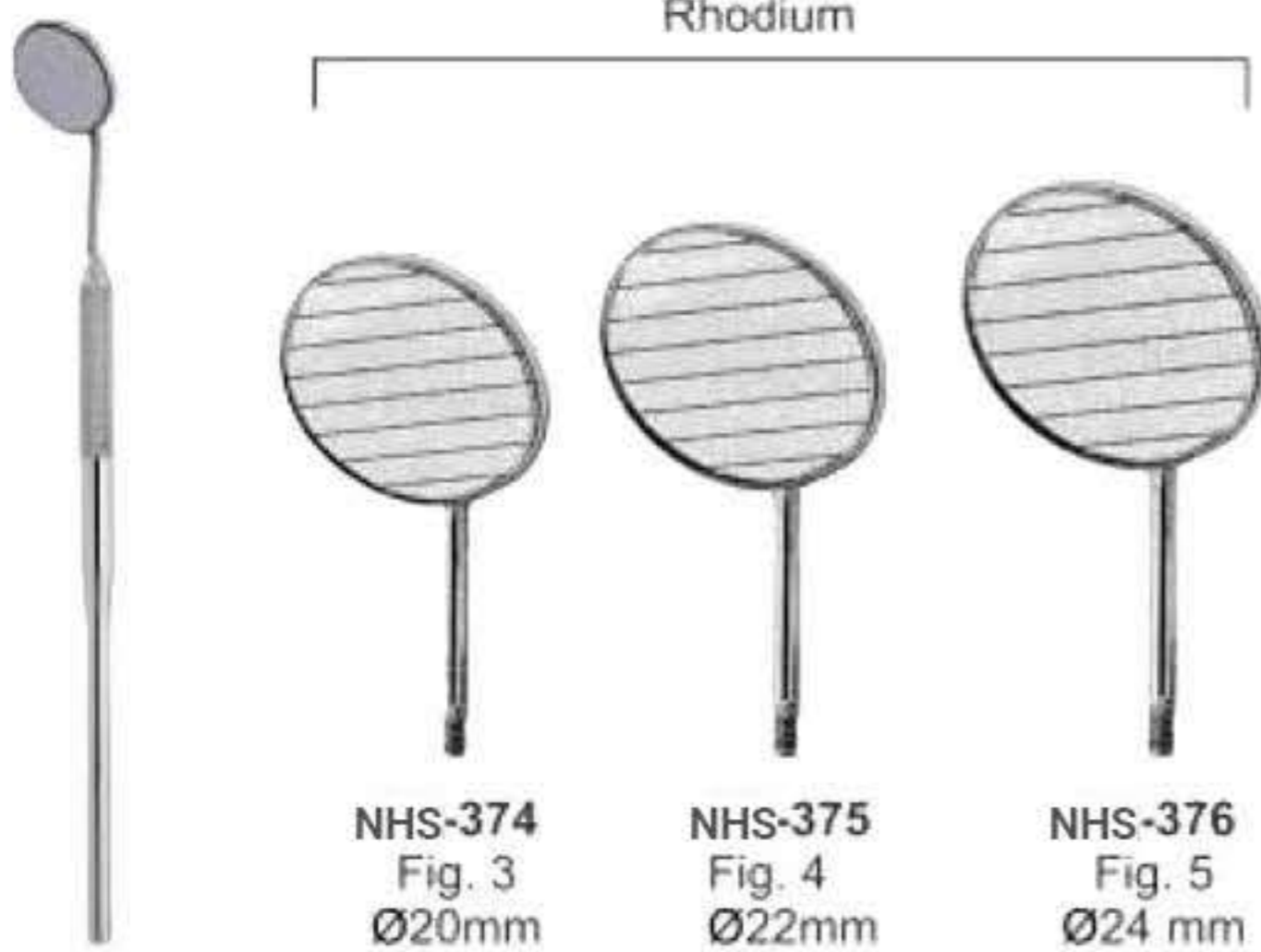

INCHES  
0 1 2 3 4 5 6 7 8 9





# TWEEZERS

- Пинцеты
- Prècelles - Brucelles
- Zahnpinzetten

- Пинцети
- Pinzas para algodón
- ملاقط



**NHS-381**  
Surgical  
11.5cm



**NHS-382**  
London College  
15cm



**NHS-383**  
Semken Taylor  
Str.



**NHS-384**  
Semken Taylor  
Cvd.



**NHS-385**  
Meriam  
16cm



**NHS-386**  
Dressing  
14cm



**NHS-387**  
Semken Taylor  
1x2 Straight



**NHS-388**  
Semken Taylor  
1x2 Curved



**NHS-389**  
Gilles  
15cm 1x2



**NHS-390**  
14cm 1x2



**NHS-391**  
Perry  
13cm



**NHS-392**  
Atraumatic  
15cm Cvd



**NHS-393**  
Atraumatic  
15cm Str.



**NHS-394**  
College with Lock  
15cm Cvd.



**NHS-395**  
Gerald  
17.5cm



**NHS-396**  
with lock  
15cm



**NHS-397**  
Atraumatic  
17.5cm

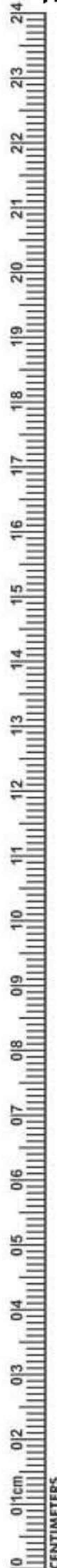

CENTIMETERS



# TWEEZERS

- Пинцеты
- Précelles - Bruxelles
- Zahnpinzetten

- Пінцети
- Pinzas para algodón
- پینسا



**NHS-398**  
Adson-TC  
12cm



**NHS-399**  
Adson-TC  
12cm 1x2



**NHS-400**  
Adson-TC  
15cm 1x2



**NHS-401**  
Adson  
12cm



**NHS-402**  
Adson  
12cm 1x2



**NHS-403**  
Adson  
15cm 1x2



**NHS-404**  
Adson Brown  
12cm



**NHS-405**  
Crane Kaplan  
15cm



**NHS-406**  
Crane Kaplan  
15cm



**NHS-407**  
Crane Kaplan  
15cm



**NHS-408**  
Hemingway  
15cm



**NHS-409**  
Miller  
15cm Str.



**NHS-410**  
Miller  
15cm Cvd.



**NHS-411**  
Dressing  
Tweezer  
14.5cm



**NHS-412**  
College  
Curved  
Tip 15cm



**NHS-413**  
Maryam  
Tweezers  
15cm



**NHS-414**  
College  
Tweezer  
15cm



**NHS-415**  
Perry  
Tweezer  
12.5cm



**NHS-416**  
Self-locking  
Tweezer  
15cm







- Зонды
- Sondes
- Zahnsonden
- Зонди
- Sondas
- المستكشفين

Single Ended Probe Solid Handle 4.5mm Length 150mm

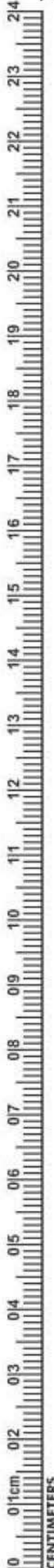
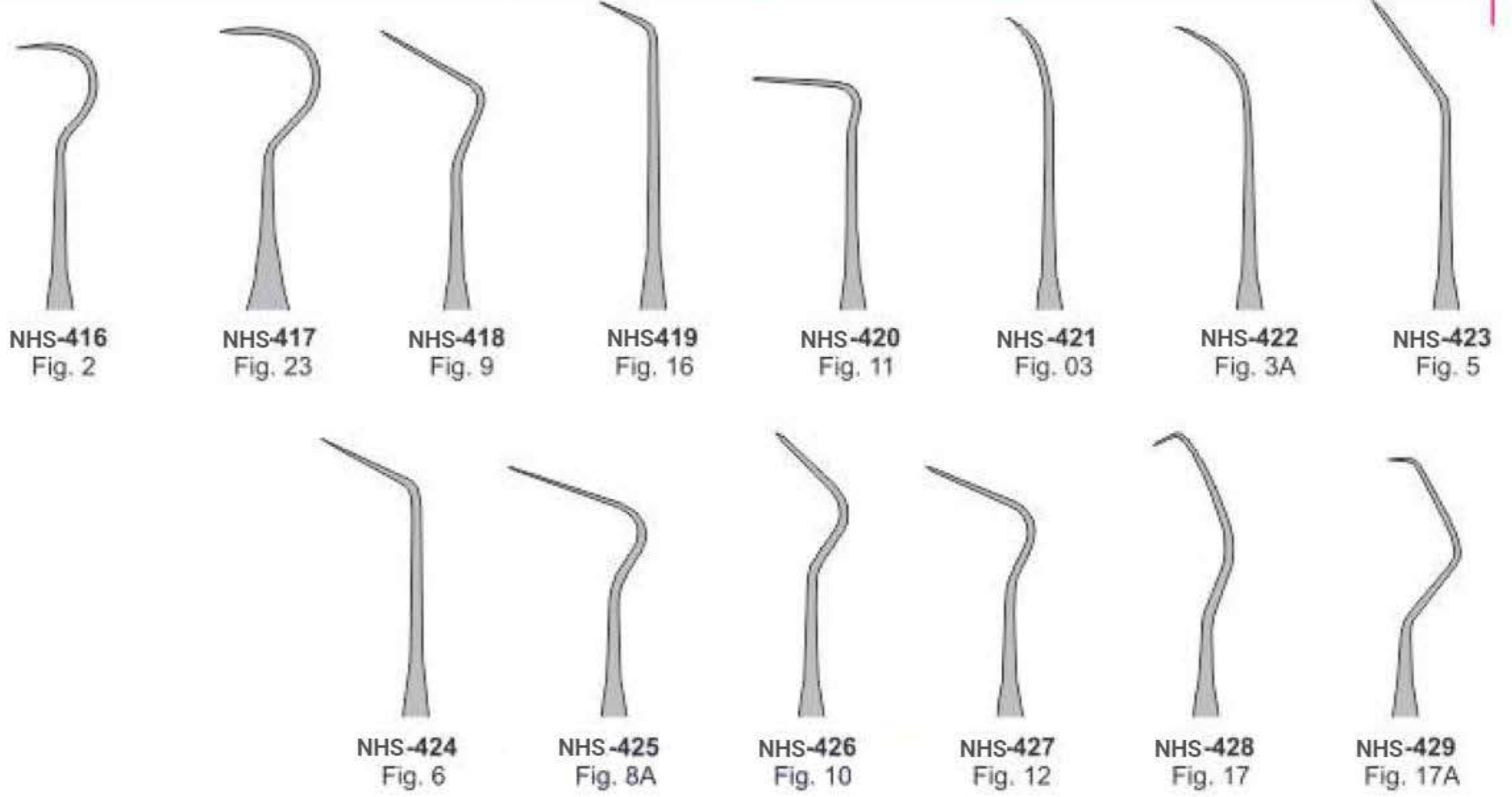

Fig. 2 Normal Handle



NHS-416 Fig. 2

NHS-417 Fig. 23

NHS-418 Fig. 9

NHS-419 Fig. 16

NHS-420 Fig. 11

NHS-421 Fig. 03

NHS-422 Fig. 3A

NHS-423 Fig. 5

NHS-424 Fig. 6

NHS-425 Fig. 8A

NHS-426 Fig. 10

NHS-427 Fig. 12

NHS-428 Fig. 17

NHS-429 Fig. 17A

Single Ended Probe Hollow Handle 8.5mm Length 150mm



Fig. 2 Anatomic Handle

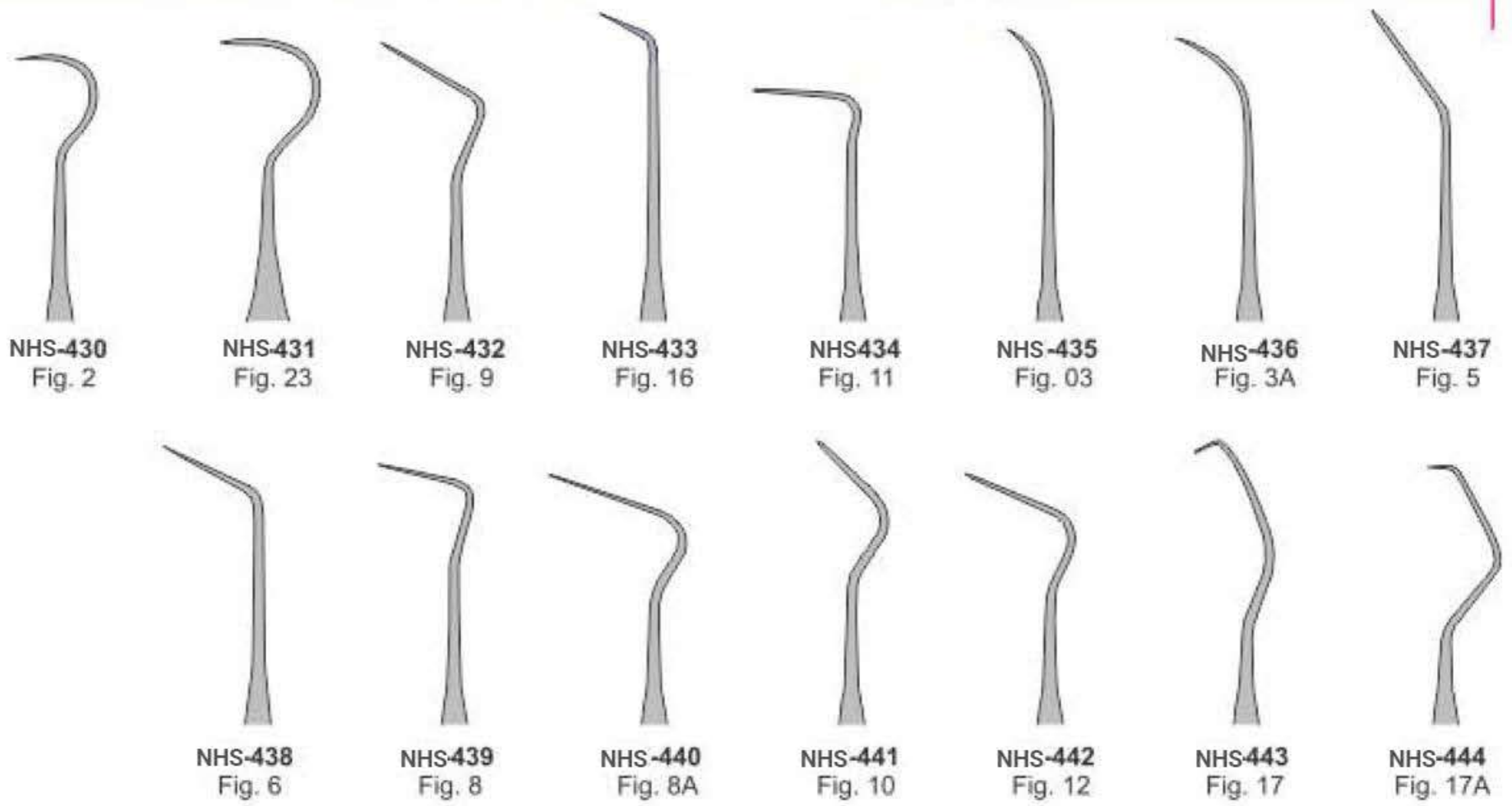

NHS-430 Fig. 2

NHS-431 Fig. 23

NHS-432 Fig. 9

NHS-433 Fig. 16

NHS-434 Fig. 11

NHS-435 Fig. 03

NHS-436 Fig. 3A

NHS-437 Fig. 5

NHS-438 Fig. 6

NHS-439 Fig. 8

NHS-440 Fig. 8A

NHS-441 Fig. 10

NHS-442 Fig. 12

NHS-443 Fig. 17

NHS-444 Fig. 17A



# EXPLORERS

- Зонды
- Sondes
- Zahnsonden
- Зонди
- Sondas
- المستكشفين

Probes Single End Solid Handle 6mm, length 150mm

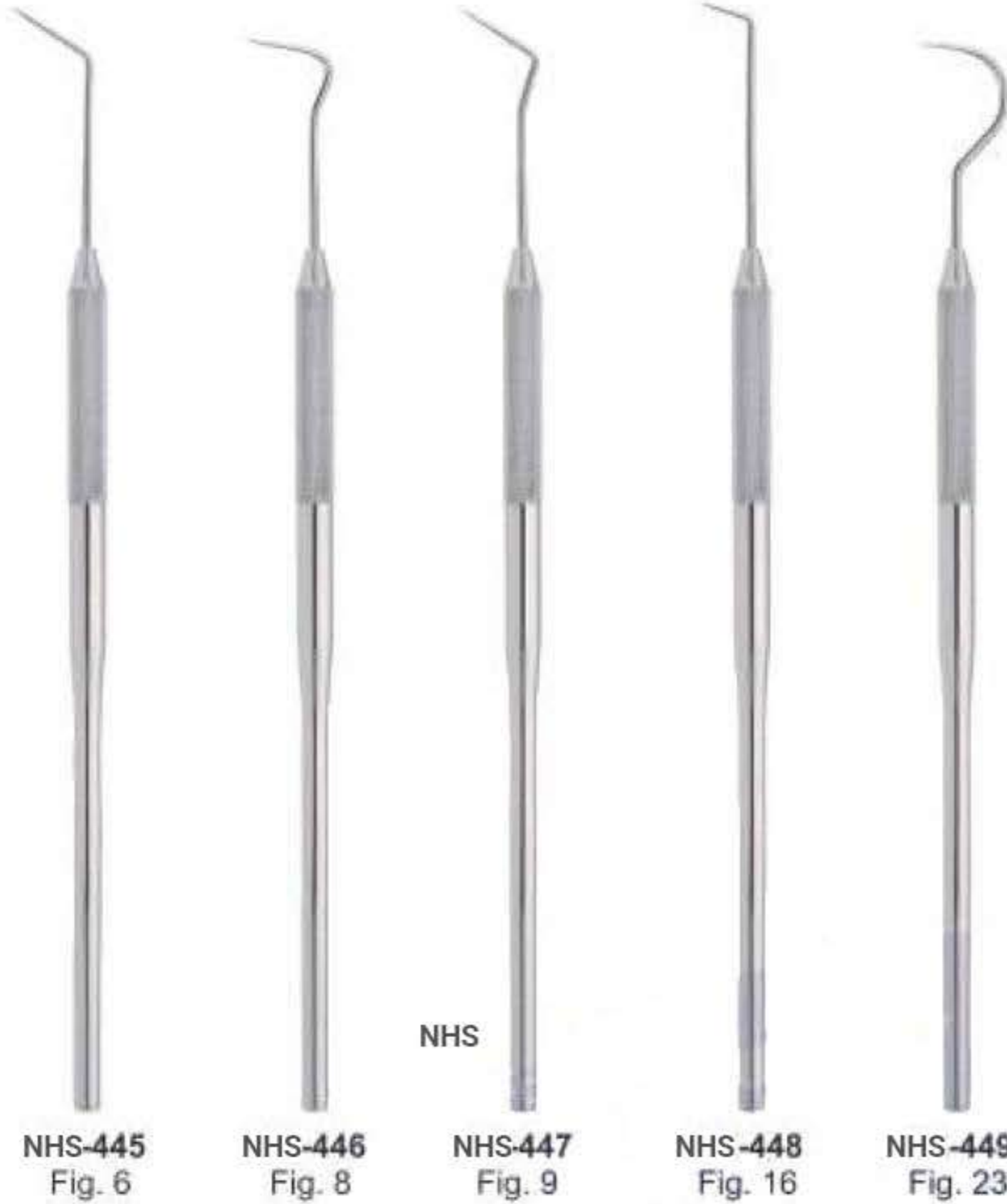

Probes Single Ended 6mm, length 150mm

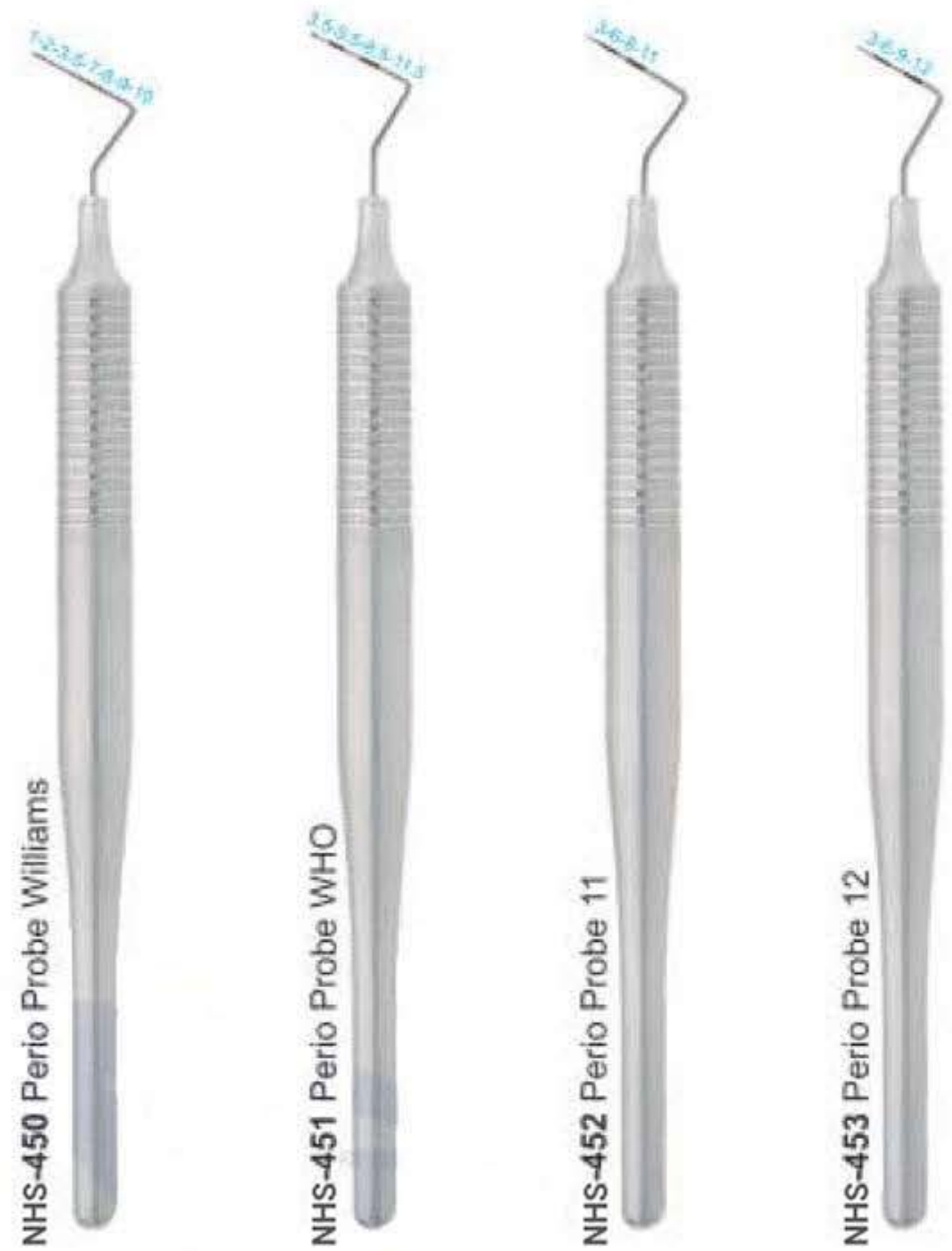

Examination kit Set of 3 Pieces



NHS-454 Probe    NHS-455 Mirror    NHS-456 College Forcep 15cm

Examination Set of 4 Pieces



Examination Set of 4 Pieces



NHS-457 Exp,23/17-A    NHS-458 Exavators    NHS-459 Tweezers    NHS-460 Mouth Mirror







EXPLORERS INSTRUMENTS  
SOLID HANDLE 6MM, LENGTH 170MM

- Зонды
- Sondes
- Zahnsonden
- Зонди
- Sondas
- المستكشفين

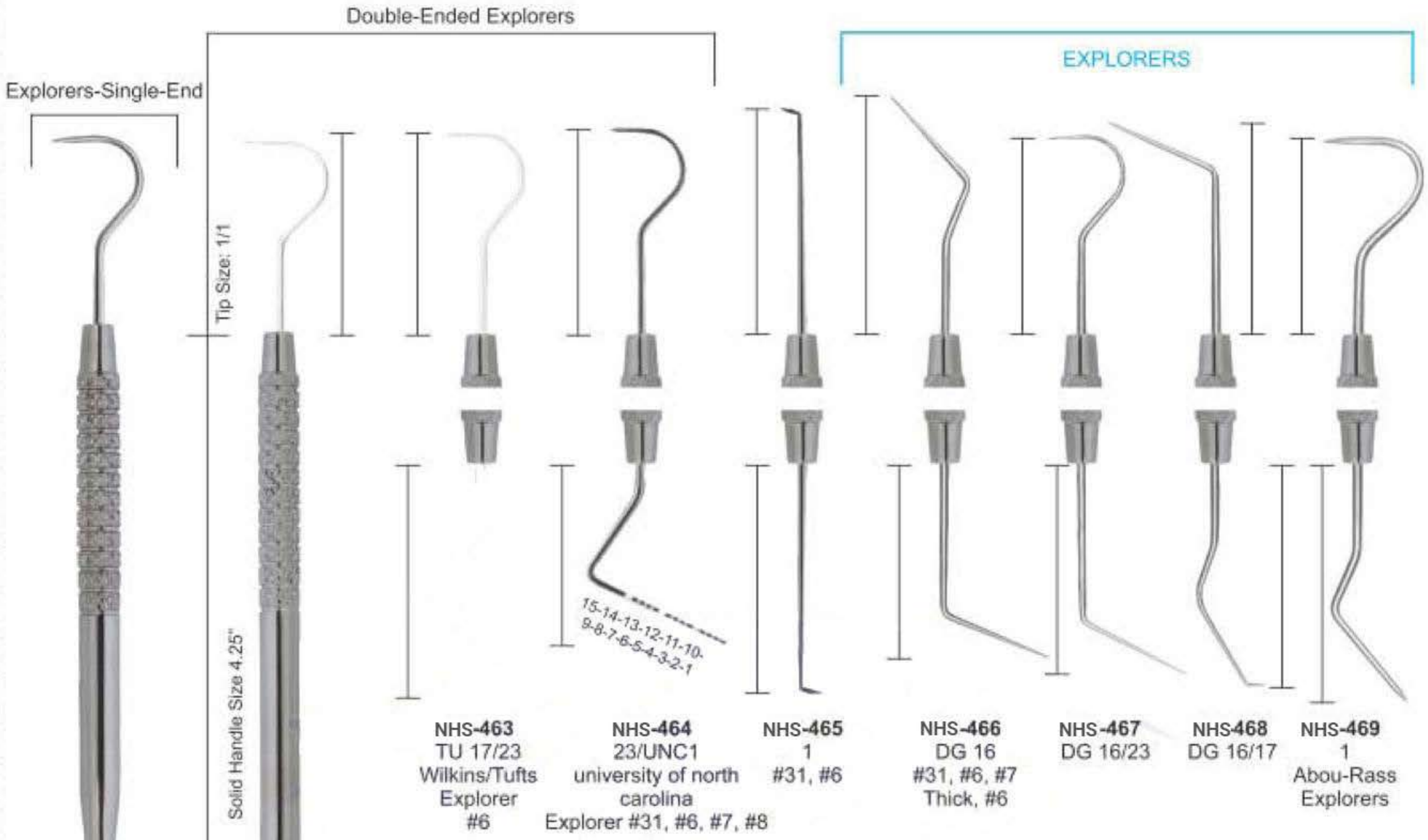
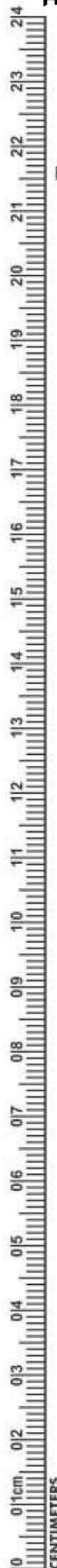

Probes Double Ended 6mm, length 170mm

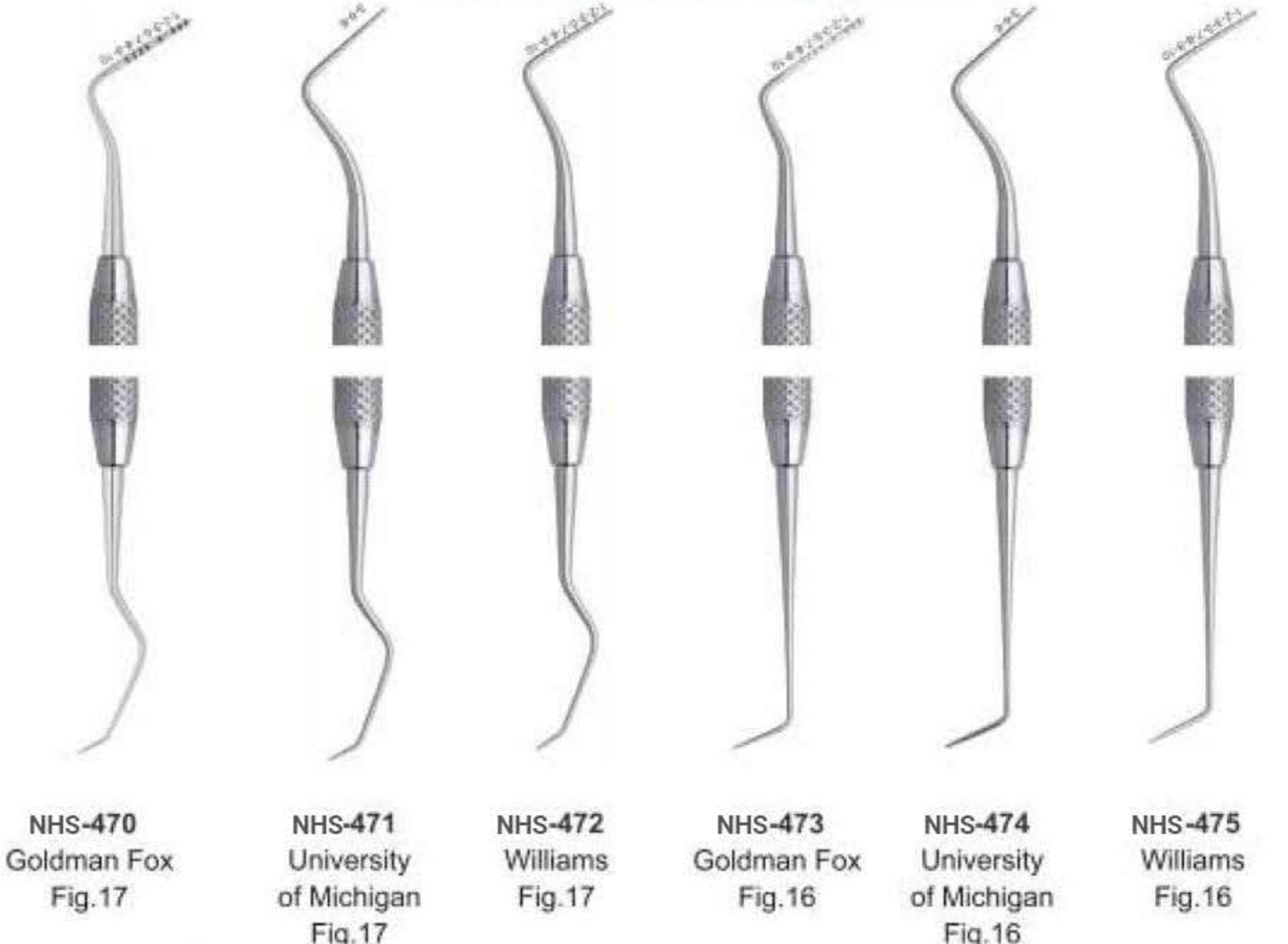

NHS-461 23 Shepherd's Hook Explorer #30, #6, #7, #8

NHS-462 #5, #6 Explorer



# EXPLORERS

- Зонды
- Sondes
- Zahnsonden
- Зонди
- Sondas
- المستكشفين

Pointed Probes Single Ended Handle 6mm, length 150mm



Pointed Probes Double Ended Handle 6mm, length 170mm





- Инструменты пародонтологические
- Instruments pour la parodontologie
- Instrumente für die Parodontologie
- Інструменти пародонтологічні
- instrumentos para periodoncia
- المسكوك اللثة

## PERIODONTAL SET OF 10 PIECES SOLID HANDLE 6MM LENGTH 170MM

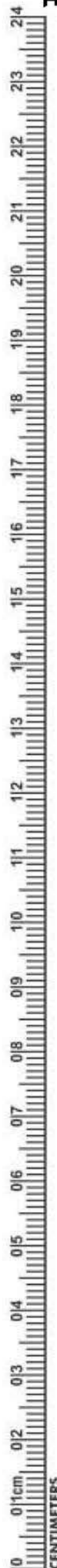



# EXPLORERS

- Зонды
- Sondes
- Zahnsonden
- Зонди
- Sondas
- المستكشفين

WILLIAM PROBE SET DOUBLE ENDED WITH HOLLOW HANDLE 9.5MM, LENGTH 170MM  
CERAMIC COATED HANDLE

Proper care must be given during cleaning, sharpening and sterilization to preserve design and integrity and to prolong usefulness. Do not expose instruments to sterilization temperatures above 350 F/177 C or to higher than recommended chemical concentrations.

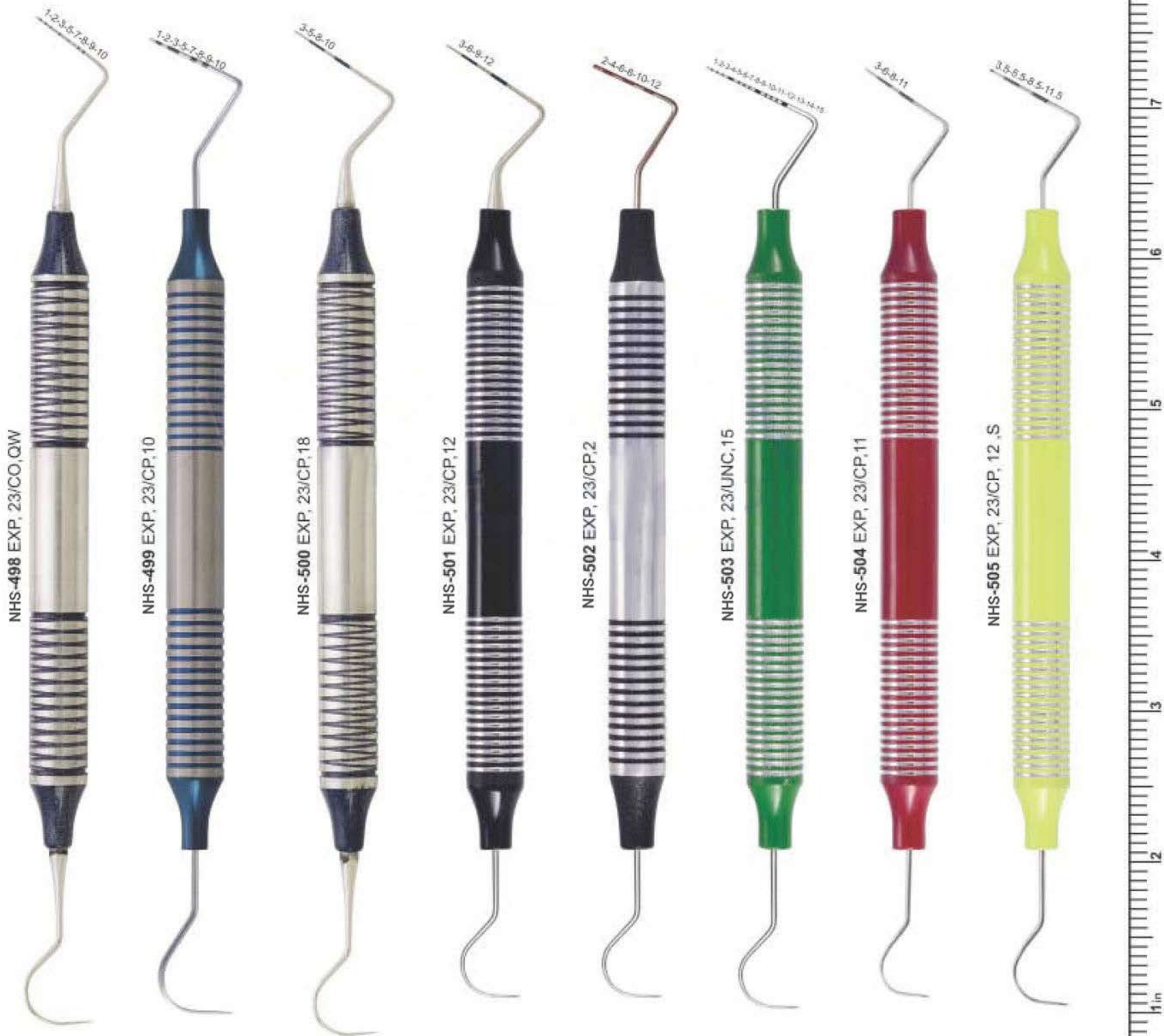





# PERIODONTAL INSTRUMENTS

- Инструменты пародонтологические
- Instruments pour la parodontologie
- Instrumente für die Parodontologie

- Інструменти пародонтологічні
- instrumentos para periodoncia
- المسكوك اللثة

## PERIODONTAL INSTRUMENTS SET OF 11 PCS SOLID HANDLE 6MM, LENGTH 170MM

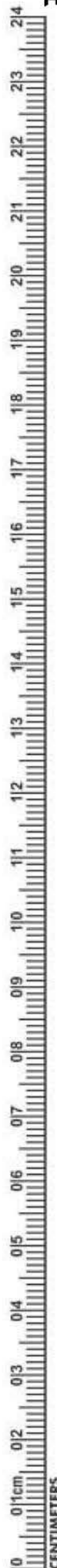

NHS-506 Tweezer 125mm

125MM



NHS-507 Dental Mirror



NHS-508 Excavator



NHS-509 Heidmann



NHS-510 Gracey



NHS-511 Filling Ins



NHS-512 Hollanback



NHS-513 Plugger



NHS-514 Sickle



NHS-515 Explorer



NHS-516 Cutting Ins



# CURETTES

- Кюрети
- Curetas
- Küretten
- Кюрети
- Curette
- كرتس

**GRACEY SET OF 7 PCS HOLLOW HANDLE 9.5MM, LENGTH 170MM**

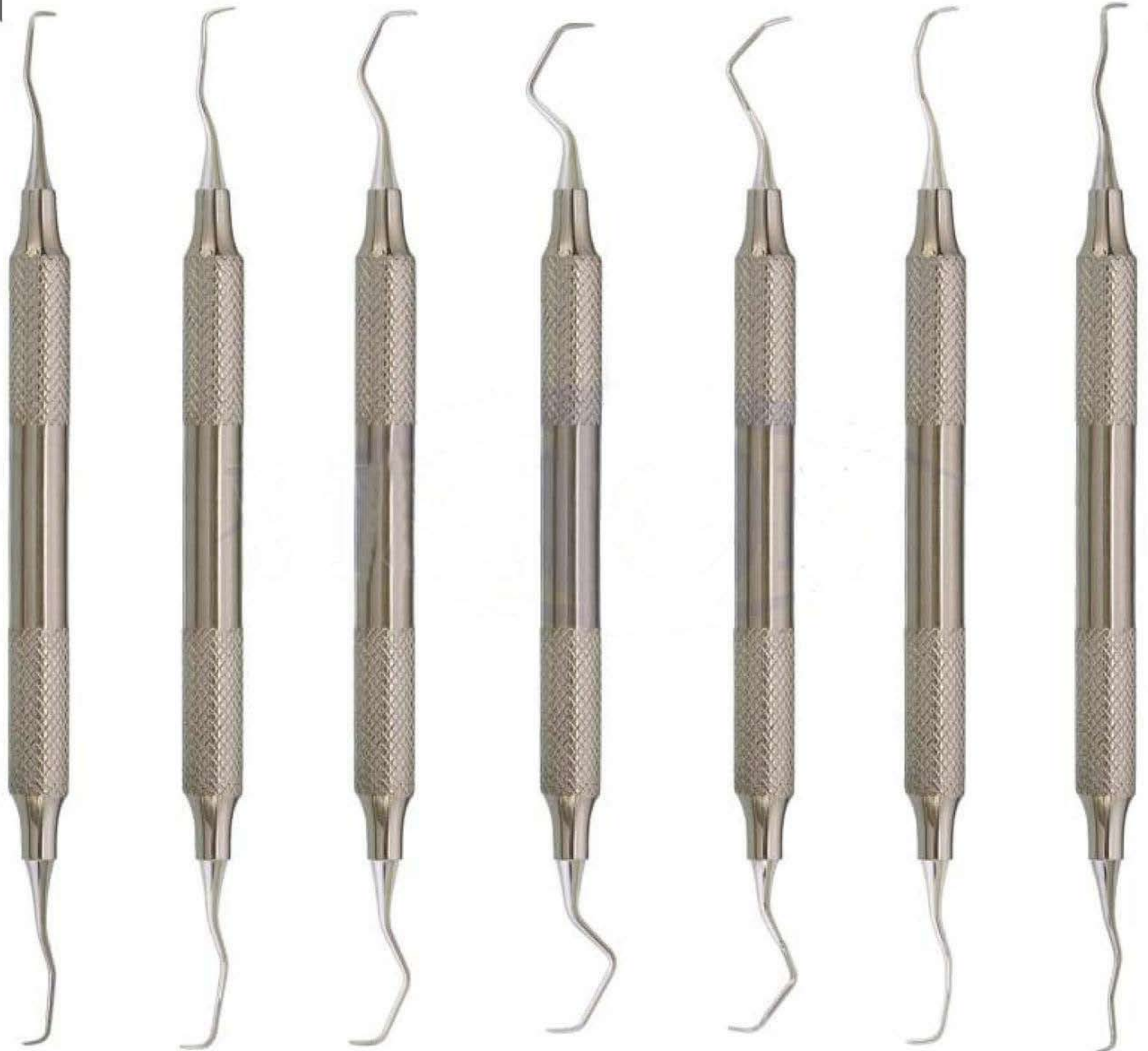

**NHS-517  
GRACEY  
1/2**

**NHS-518  
GRACEY  
3/4**

**NHS-519  
GRACEY  
5/6**

**NHS-520  
GRACEY  
7/8**

**NHS-521  
GRACEY  
9/10**

**NHS-522  
GRACEY  
11/12**

**NHS-523  
GRACEY  
13/14**





- Кюрети
- Curetas
- Kuretten
- Кюрети
- Curette
- كرتس

GRACEY SET OF 7 PCS  
HOLLOW HANDLE 9.5MM, LENGTH 170MM WITH SILICON GRIP

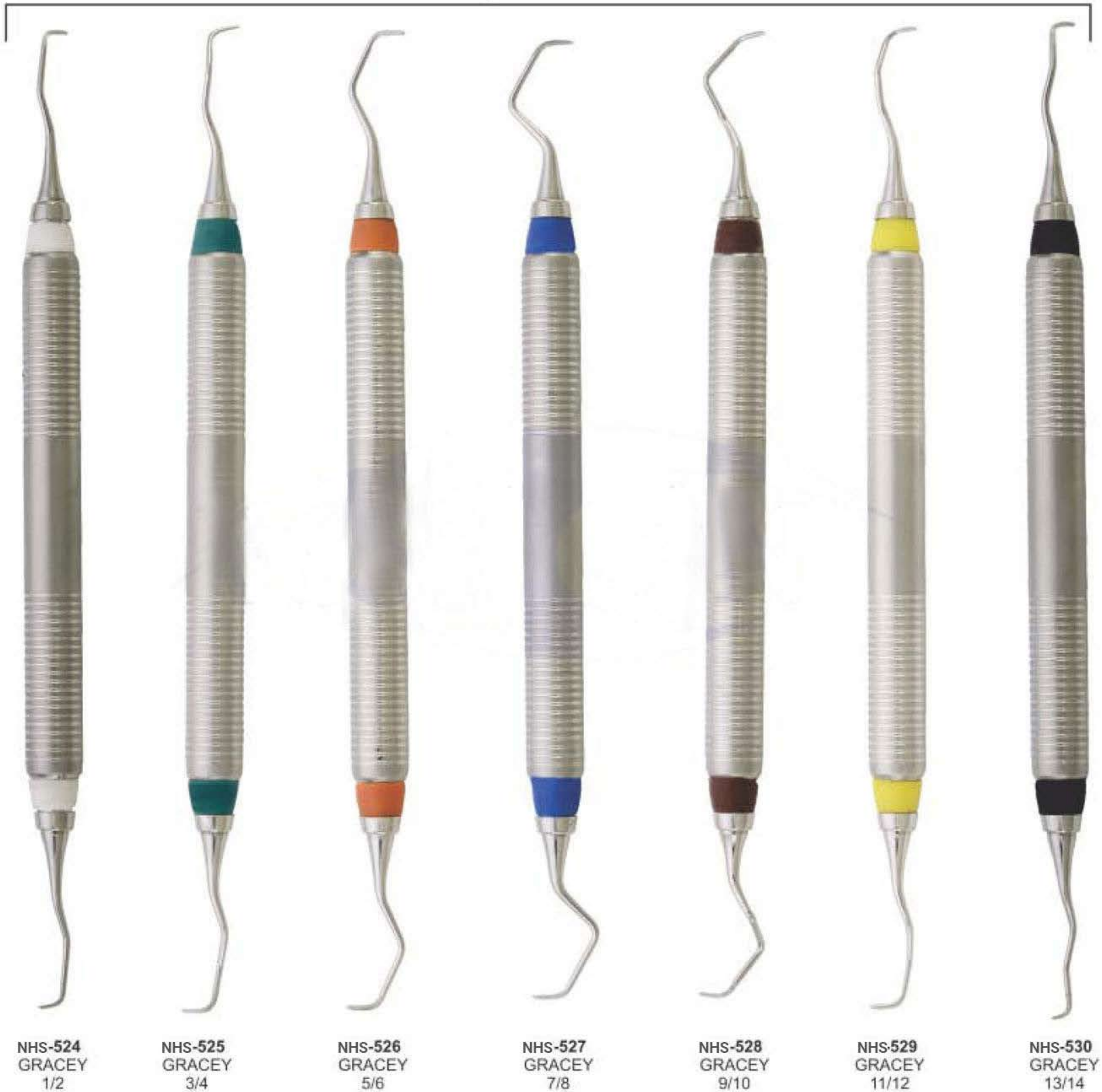
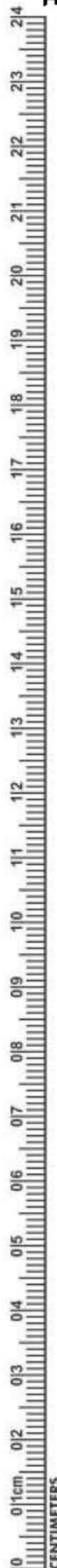



# CURETTES

- Кюрети
- Curetas
- Küretten
- Кюрети
- Curette
- کرتس

## GRACEY MINI FIVE

HOLLOW HANDLE 9.5MM, LENGTH 170MM  
CERAMIC COATED HANDLE



NHS-531 Gracey 1/2  
NHS-532 Gracey 3/4  
NHS-533 Gracey 5/6  
NHS-534 Gracey 7/8  
NHS-535 Gracey 11/12  
NHS-536 Gracey 13/14

## GRACEY AFTER FIVE

HOLLOW HANDLE 9.5MM, LENGTH 170MM  
CERAMIC COATED HANDLE



NHS-537 Gracey 1/2 AF  
NHS-538 Gracey 3/4 AF  
NHS-539 Gracey 5/6 AF  
NHS-540 Gracey 7/8 AF  
NHS-541 Gracey 11/12 AF  
NHS-542 Gracey 13/14 AF

Proper care must be given during cleaning, sharpening and sterilization to preserve design and integrity and to prolong usefulness. Do not expose instruments to sterilization temperatures above 350 F/177 C or to higher than recommended chemical concentrations.

INCHES  
0  
1  
2  
3  
4  
5  
6  
7  
8  
9





- Кюрети
- Curetas
- Kuretten
- Кюрети
- Curette
- كرتس

GRACEY CURETTE  
HOLLOW HANDLE 10MM, LENGTH 170MM

Curetters Set of 8 Pieces

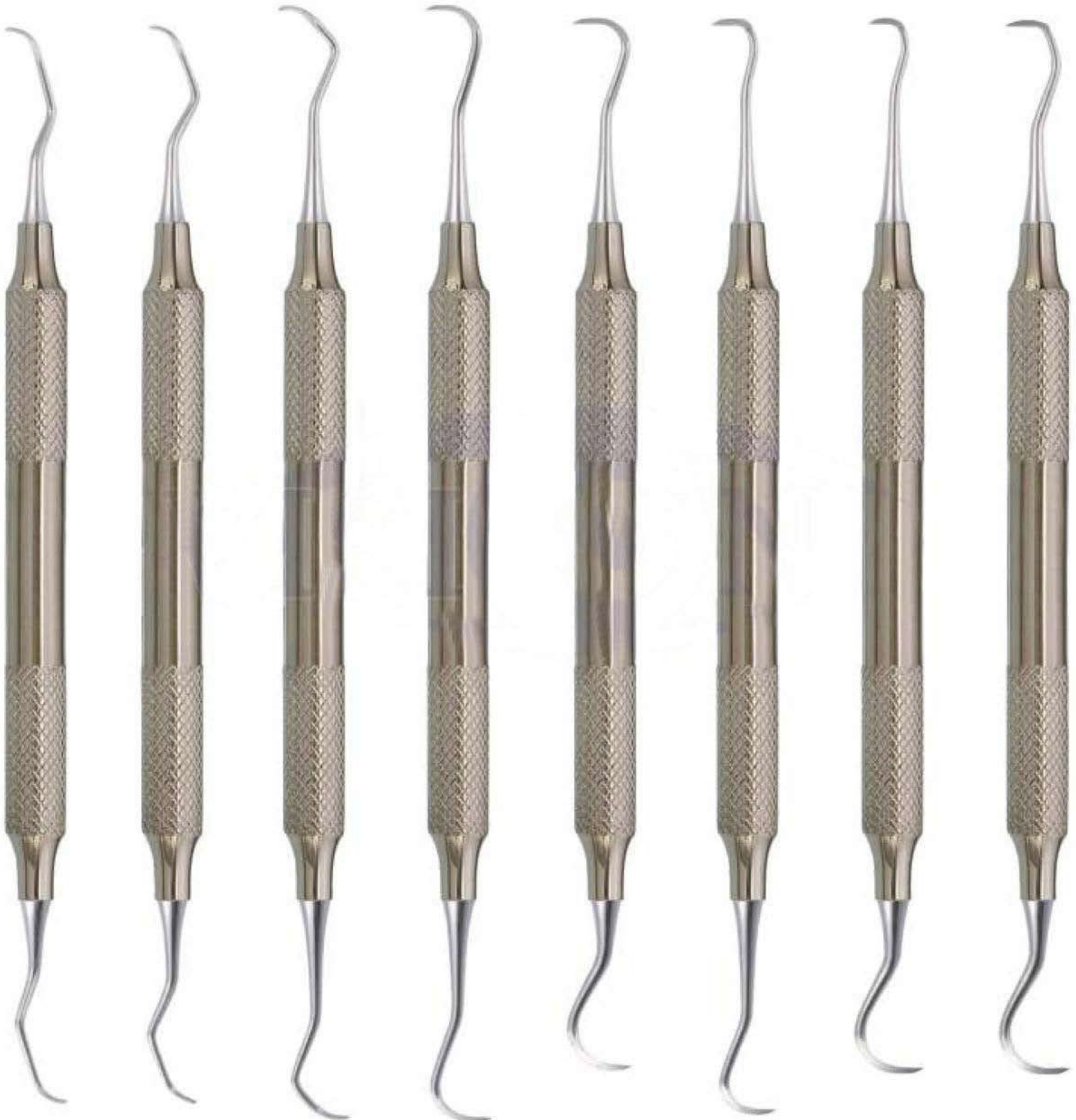

NHS-543  
Curette  
Columbia  
2L-2R

NHS-544  
Curette  
Columbia  
4L-4R

NHS-545  
Curette  
McCall  
13S-14S

NHS-546  
H6-H7  
Scaler  
Sickle

NHS-547  
H5-U15  
Scaler  
Sickle

NHS-548  
H5-13  
Scaler  
Sickle

NHS-549  
U15-30  
Scaler  
Sickle

NHS-550  
U15-33  
Scaler  
Sickle



# FILLING INSTRUMENTS

- Инструменты для реставрации
- Instruments pour plombage
- Füllungsinstrumente (mit Kontrawinkel)
- Інструменти для реставрації
- Instrumentos para obturaciones
- ملء الصكوك

## FILLING INSTRUMENTS (Gold Pointed) SOLID HANDLE 6MM, LENGTH 170MM



Solid Handle Size 4.25"

Tip Size: 1/1

NHS-551 1.5mm / 1.5mm

NHS-552 2.0mm / 2.0mm

NHS-553 2.0mm / 2.0mm

NHS-554 2.5mm / 2.5mm

NHS-555 1.3mm / 0.9mm

NHS-556 1.6mm / 1.3mm

NHS-557 2.4mm / 1.8mm

NHS-558 2.4mm / 2.0mm

NHS-559 1.3mm / 1.5mm

NHS-560 1.8mm / 1.2mm

Filling instrument, spatula 6 mm solid handle, length 170 mm,

Filling instrument 6 mm length 175 mm,

Filling instrument, ball 6 mm length 170 mm,

Filling instrument, ball / spatula 6 mm length 175 mm,

Filling instrument, plan / plan 6 mm length 165 mm,

INCHES









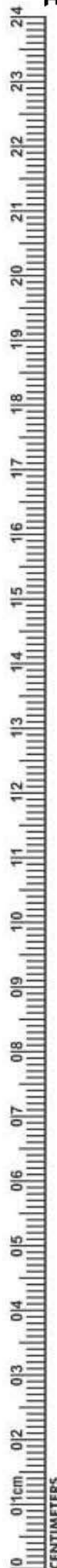





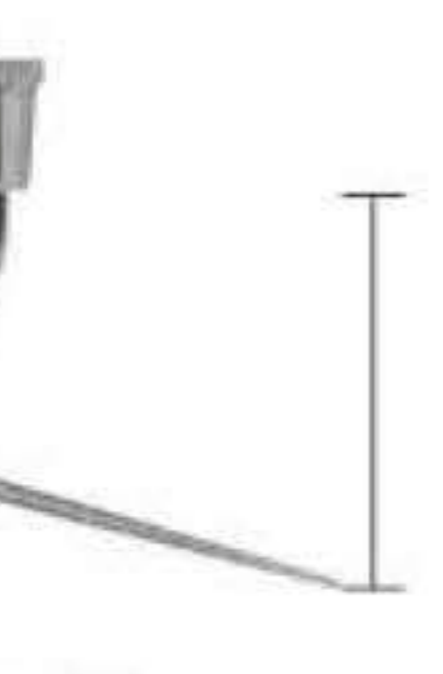

EXPLORERS INSTRUMENTS  
SOLID HANDLE 6MM, LENGTH 170MM

- Зонды
- Sondes
- Zahnsonden
- Зонди
- Sondas
- المستكشفين

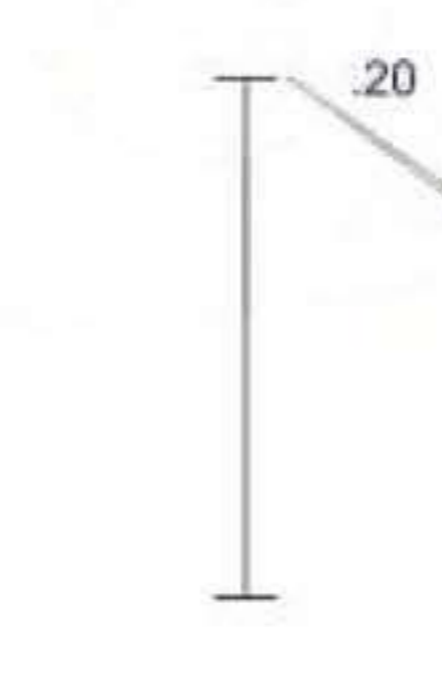
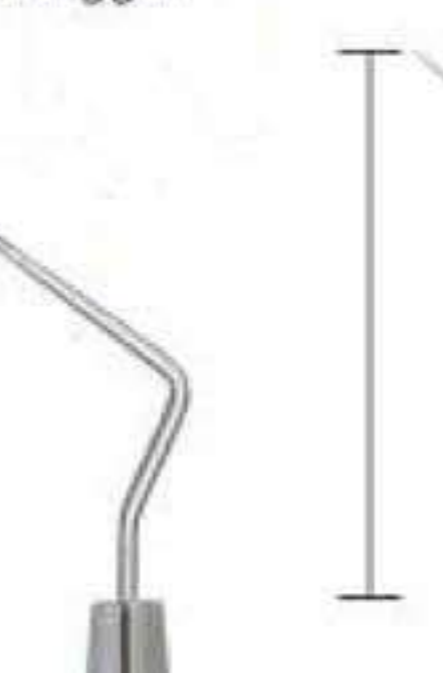

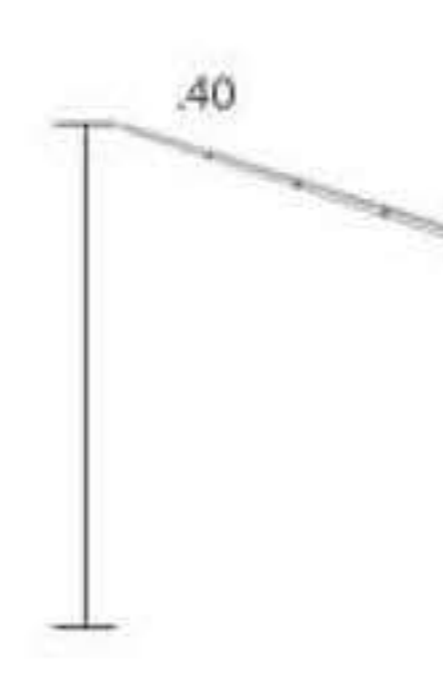
PLUGGERS

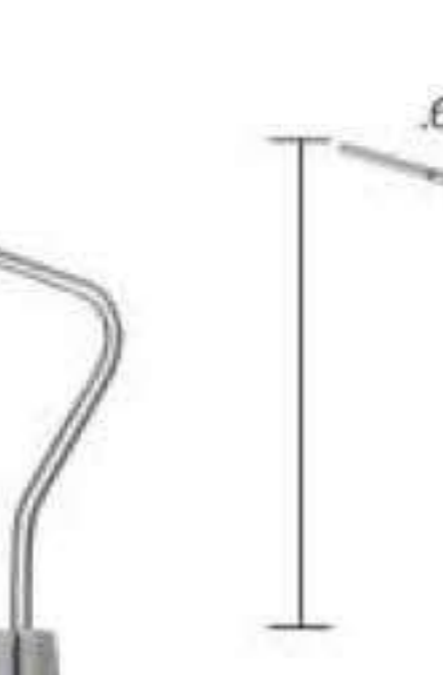
			
.50	1.00	.50	.80
			
.75	1.15	.60	1.10
<b>NHS-562</b> 5/7 21mm	<b>NHS-563</b> 9/11 21mm	<b>NHS-564</b> 1/2 Root Canal Plugger	<b>NHS-565</b> 3/4 Root Canal Plugger
			
.45	.20	.25	
<b>NHS-561</b> 1/3 21mm	<b>NHS-566</b> MA57 27mm	<b>NHS-567</b> GP3 30mm	
			
.30	.40	.50	.60
<b>NHS-568</b> ISO Size 30 24mm	<b>NHS-569</b> ISO Size 40 24mm	<b>NHS-570</b> ISO Size 50 24mm	<b>NHS-571</b> ISO Size 60 24mm



# PERIODONTAL PROBES

- Зонды пародонтологические
- Sondes paradontales
- sonda paradontali
- зонди пародонтологічні
- Sondas paradontales
- المسابر اللثة

## SPREADERS

## HEAT CARRIERS

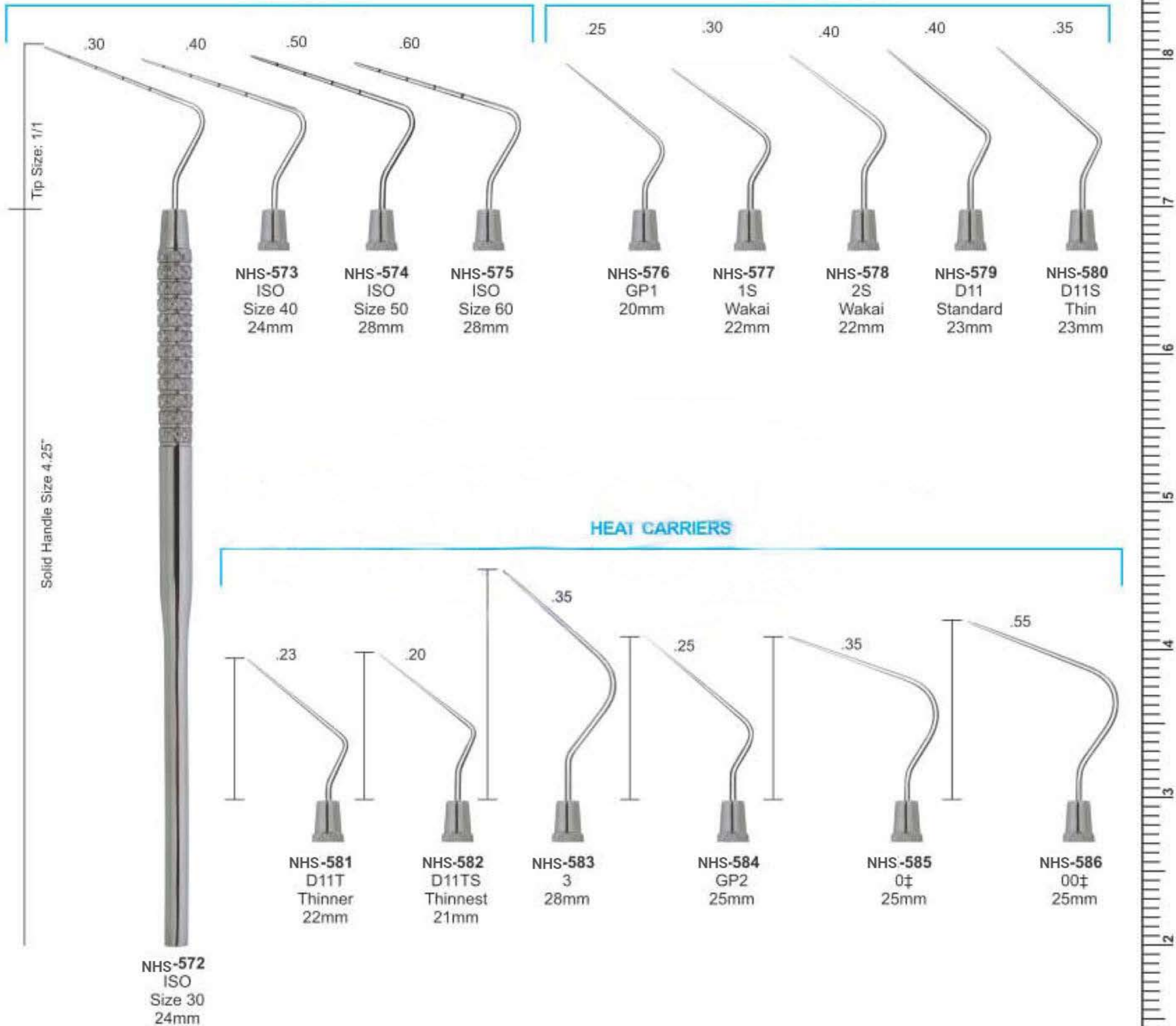



- Зонды пародонтологические
  - Sondes paradontales
  - sonde parodontali
- зонди пародонтологічні
  - Sondas paradontales
  - المسابر اللثة

## ENDODONTICS INSTRUMENTS

### ANTERIOR

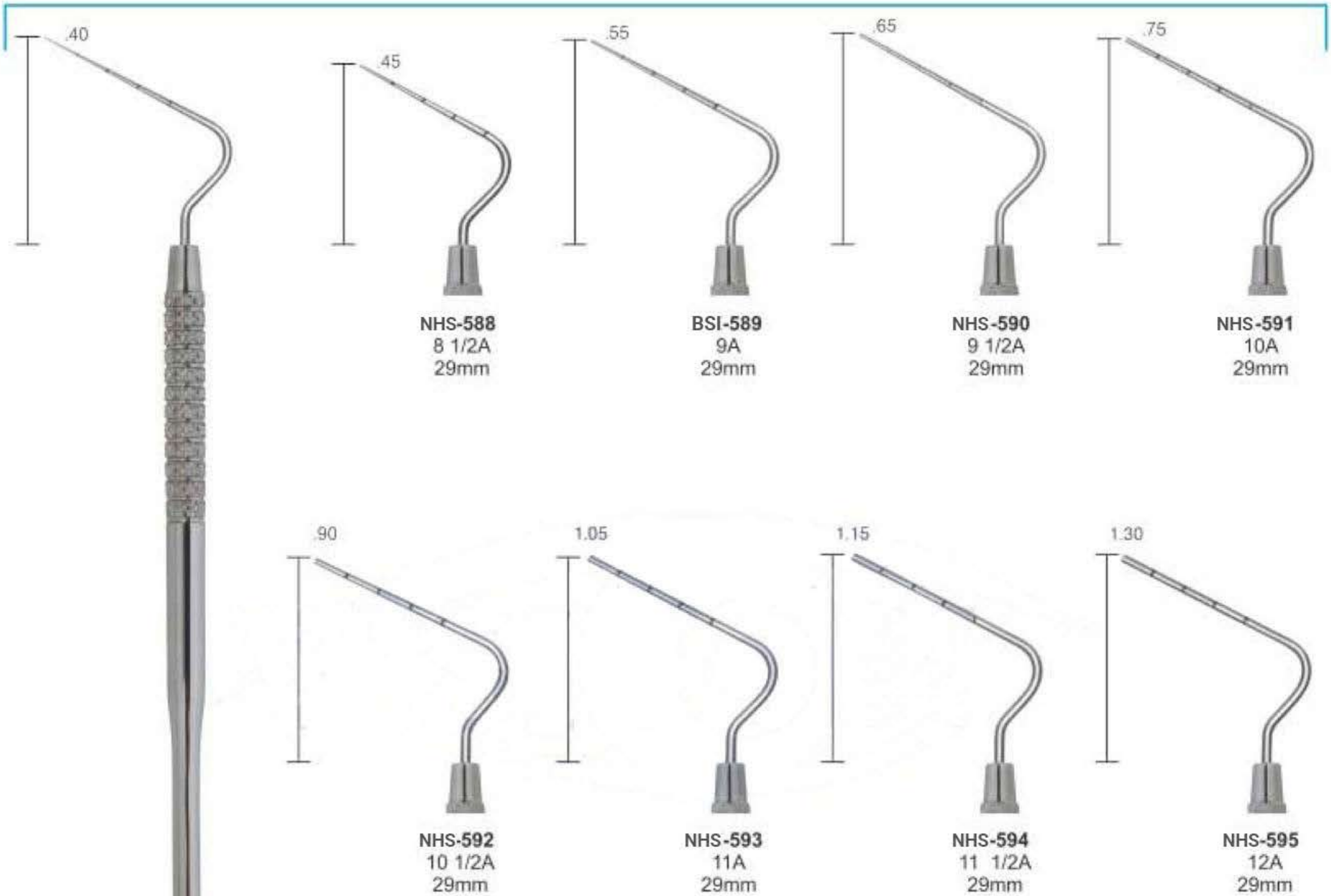

### LUKS

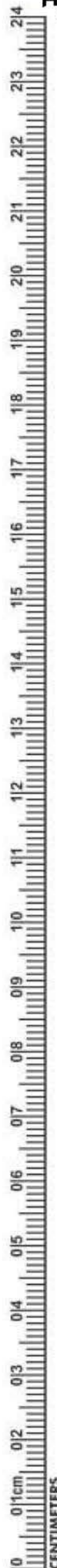



# PERIODONTAL PROBES

- Зонды пародонтологические
- Sondes paradontales
- sonda paradontali
- зонди пародонтологічні
- Sondas paradontales
- المسابر اللثة

## ENDODONTICS INSTRUMENTS SOLID HANDLE 6MM, LENGTH 170MM

### POSTERIOR

### RETRO FILLING PLUGGERS

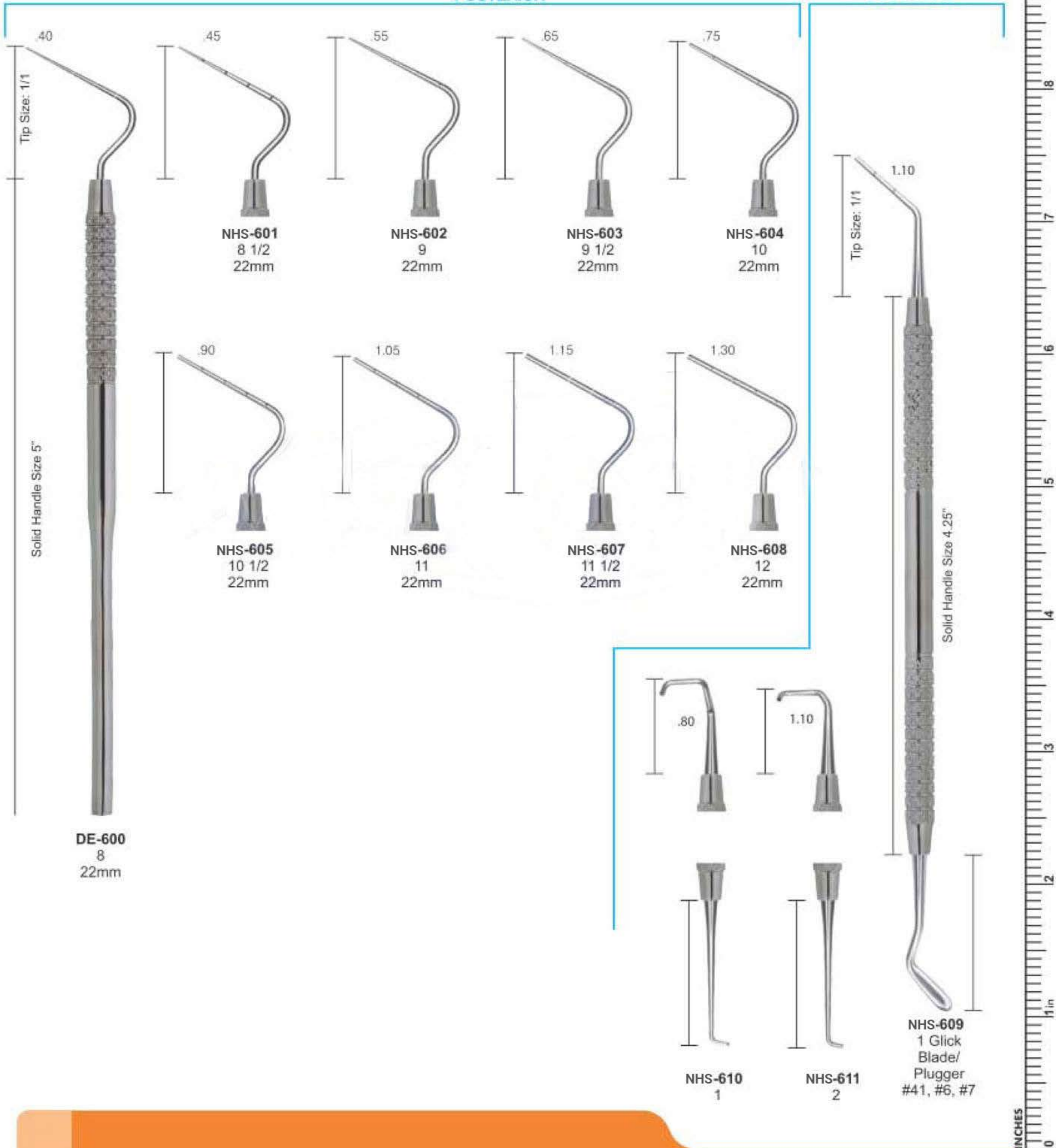

**DE-600**  
8  
22mm

**NHS-601**  
8 1/2  
22mm

**NHS-602**  
9  
22mm

**NHS-603**  
9 1/2  
22mm

**NHS-604**  
10  
22mm

**NHS-605**  
10 1/2  
22mm

**NHS-606**  
11  
22mm

**NHS-607**  
11 1/2  
22mm

**NHS-608**  
12  
22mm

**NHS-610**  
1

**NHS-611**  
2

**NHS-609**  
1 Glick  
Blade/  
Plugger  
#41, #6, #7





# FILLING INSTRUMENTS

- Инструменты для реставрации
- Instruments pour plombage
- Füllungsinstrumente (mit Kontrawinkel)

- Инструменти для реставрації
- Instrumentos para obturaciones
- ملء الصكوك

## COMPOSITE/PLASTIC FILLING INSTRUMENTS SOLID HANDLE 6MM, LENGTH 170MM

## POSTERIOR

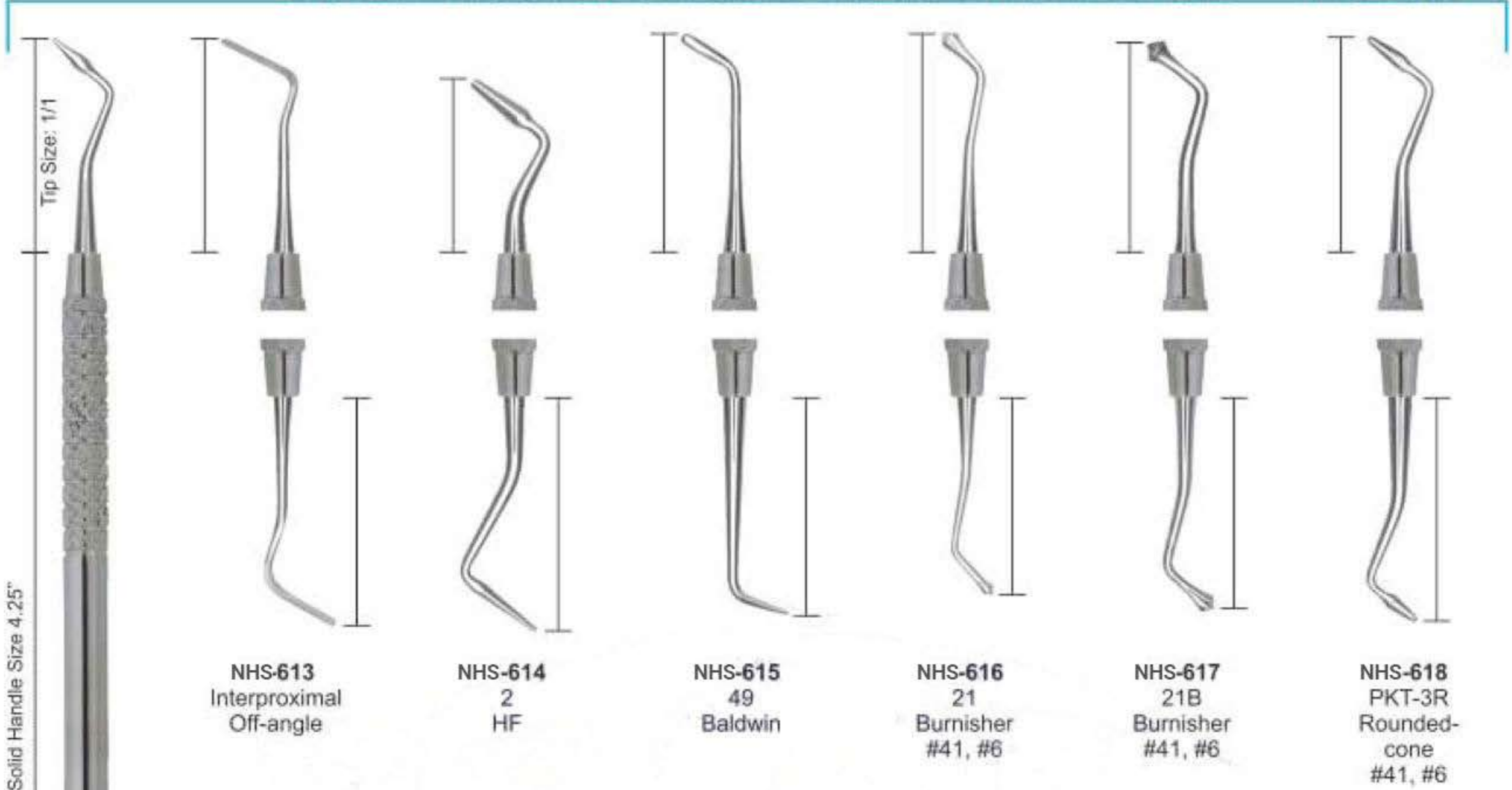
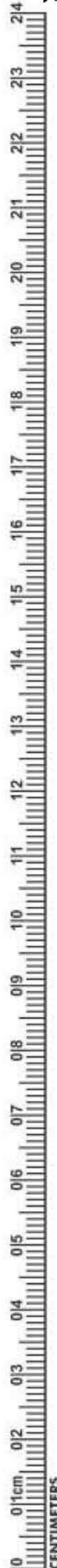

## UNIVERSAL FILLING INSTRUMENTS

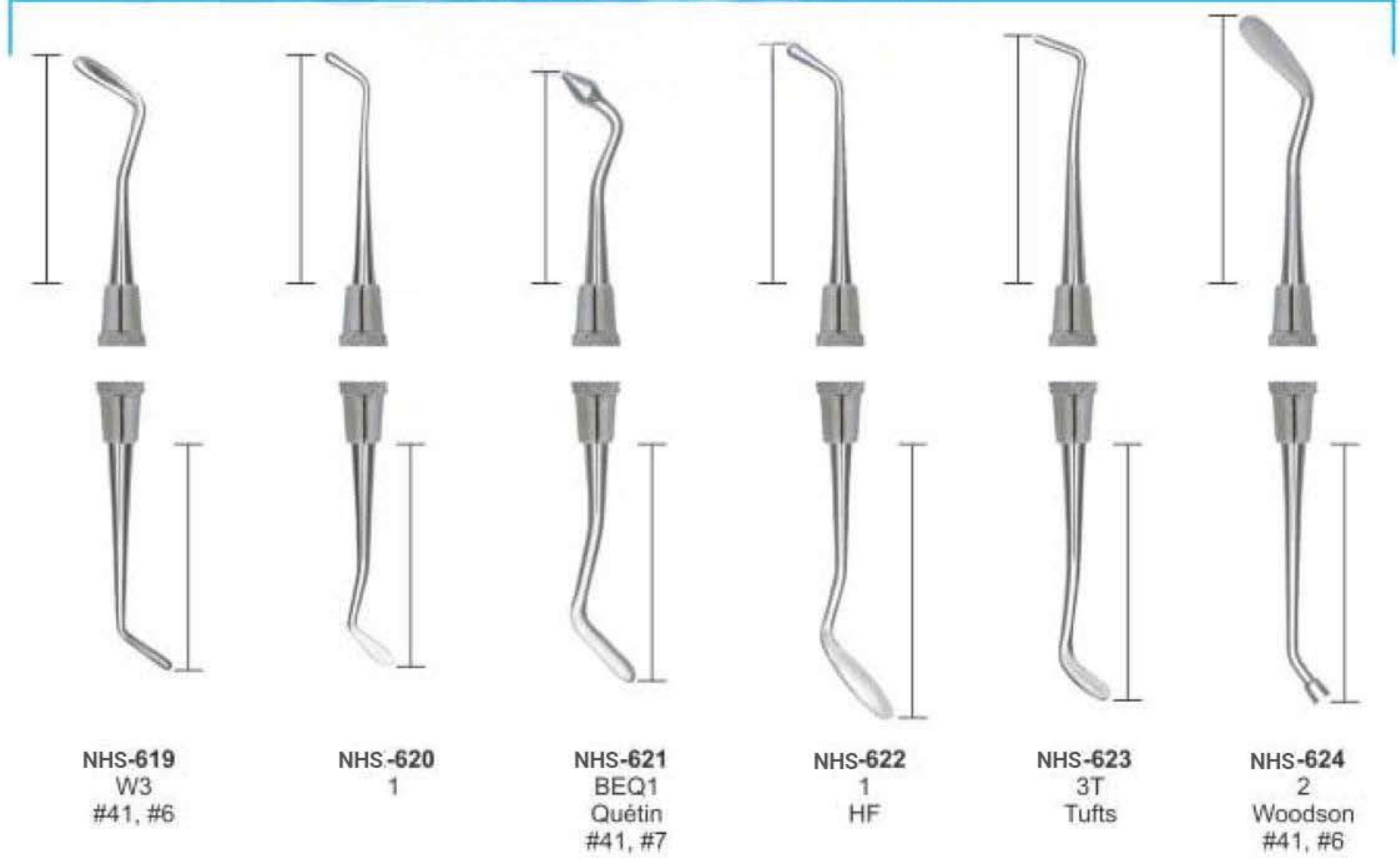



# FILLING INSTRUMENTS

- Инструменты для реставрации
- Instruments pour plombage
- Füllungsinstrumente (mit Kontrawinkel)
- Інструменти для реставрації
- Instrumentos para obturaciones
- ملء الصكوك

COMPOSITE/PLASTIC FILLING INSTRUMENTS SOLID HANDLE 6MM, LENGTH 170MM

BLACK

PLUGGERS/CONDENSERS

Hollenback

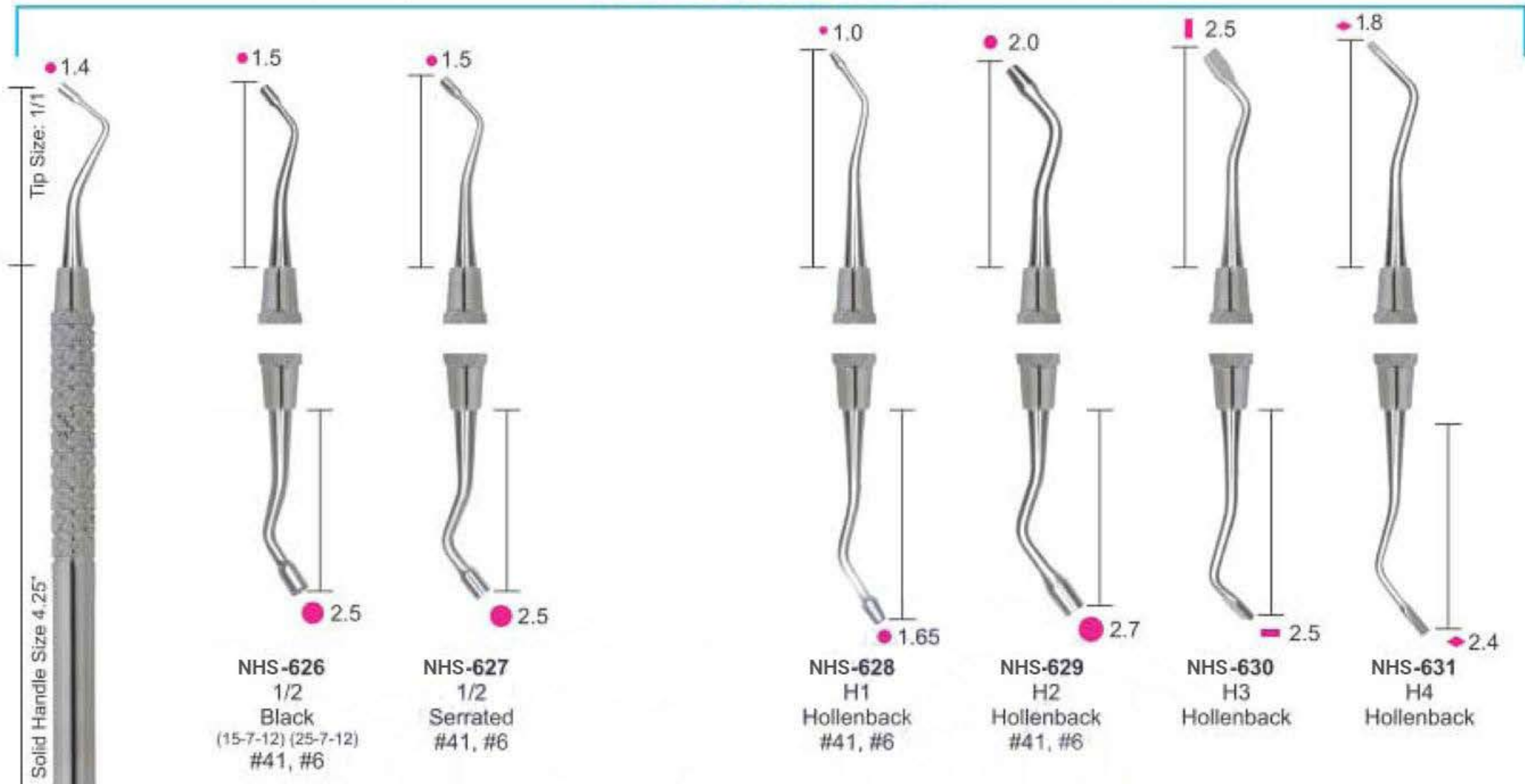

MARQUETTE CONDENSER

MORTONSON

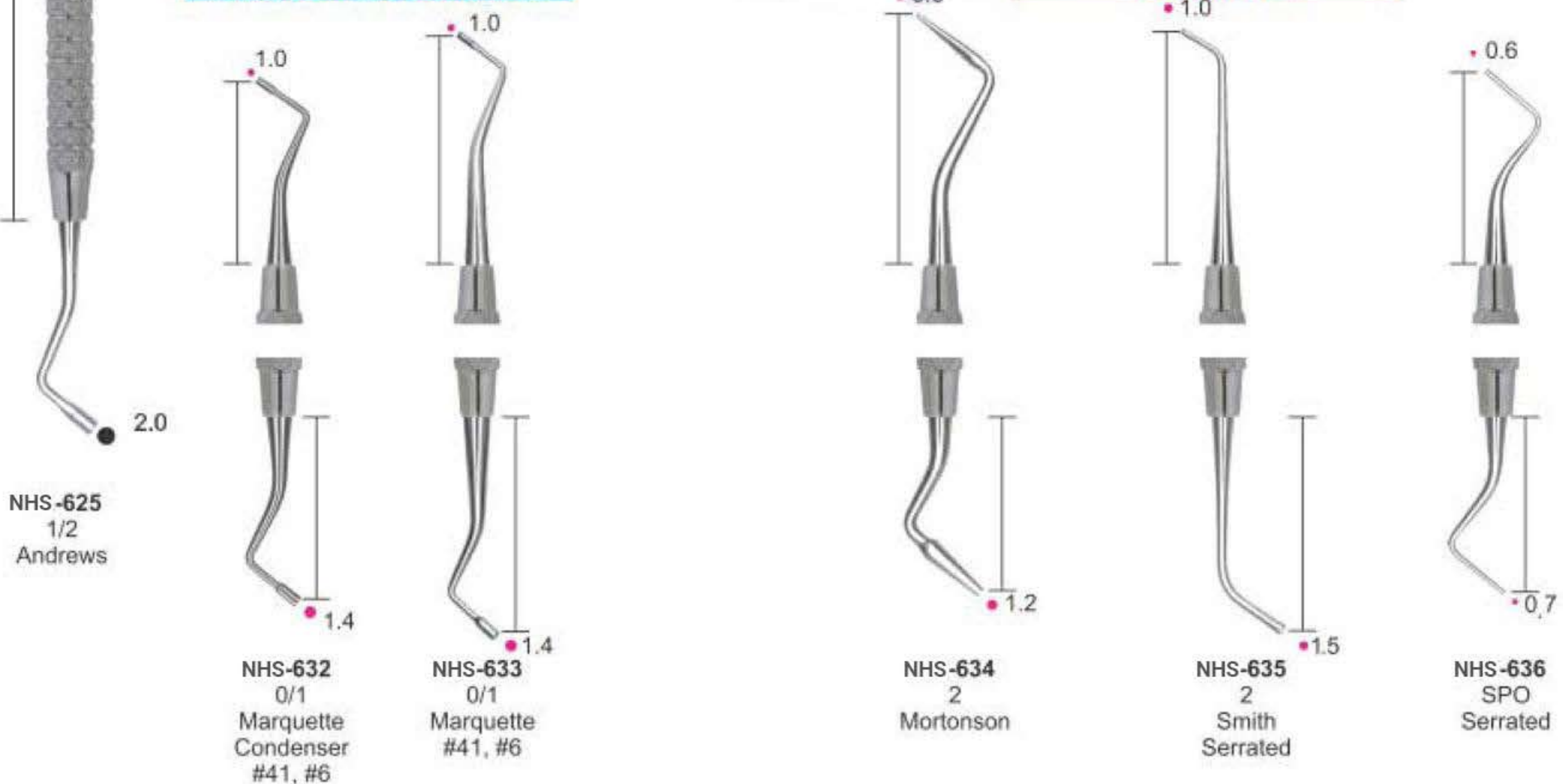



- Инструменты для реставрации
  - Instruments pour plombage
  - Füllungsinstrumente (mit Kontrawinkel)
- Инструменти для реставрації
  - Instrumentos para obturaciones
  - ملء الصكوك

## PLUGGERS/CONDENSERS

## RESTORATIVE INSTRUMENTS SOLID HANDLE 6MM, LENGTH 170MM

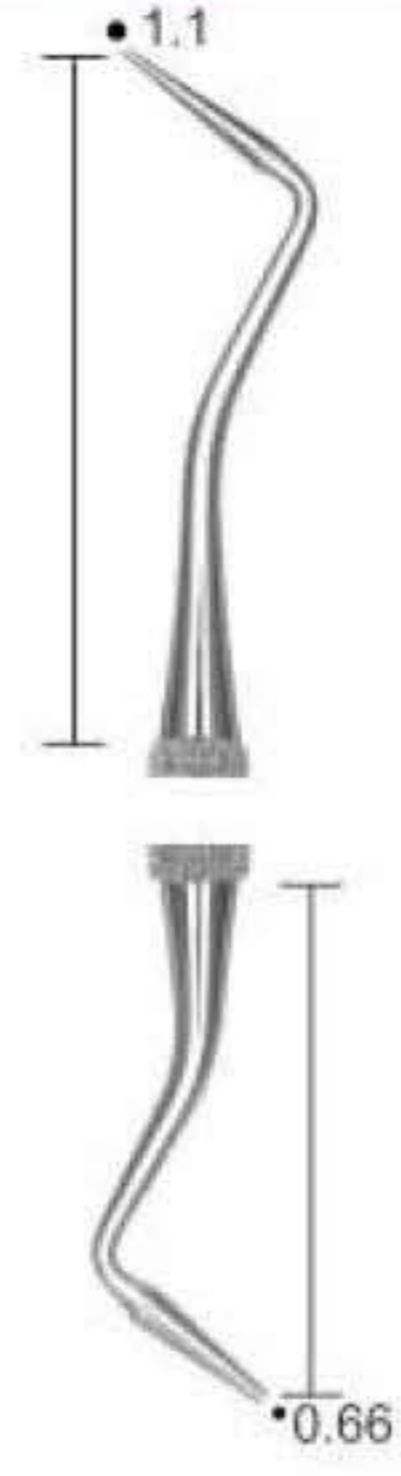
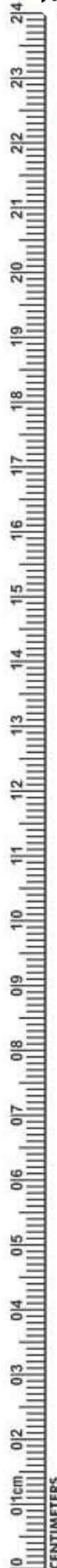

**NHS-638**  
2M  
Markley

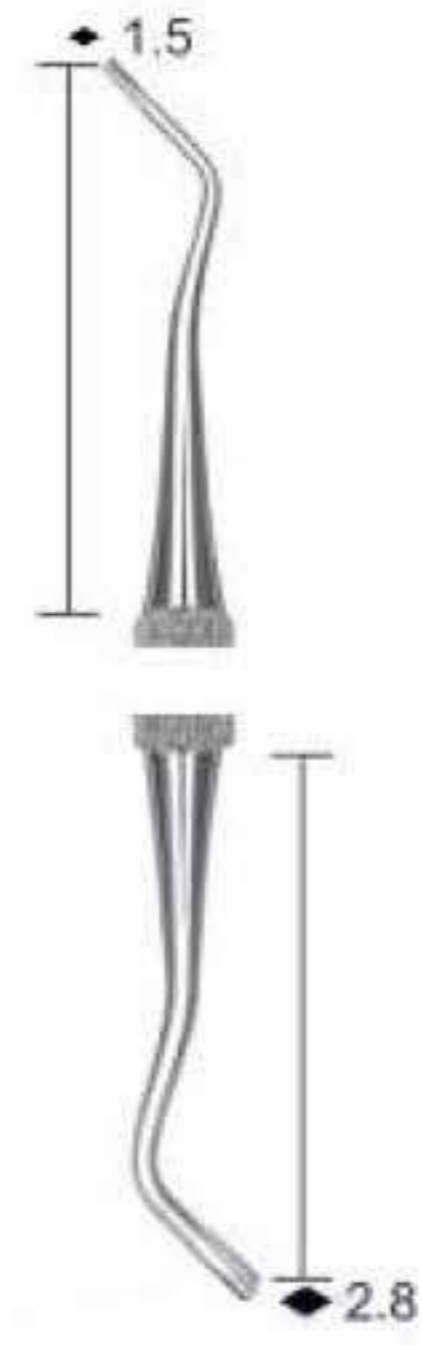

**NHS-639**  
4M  
Markley

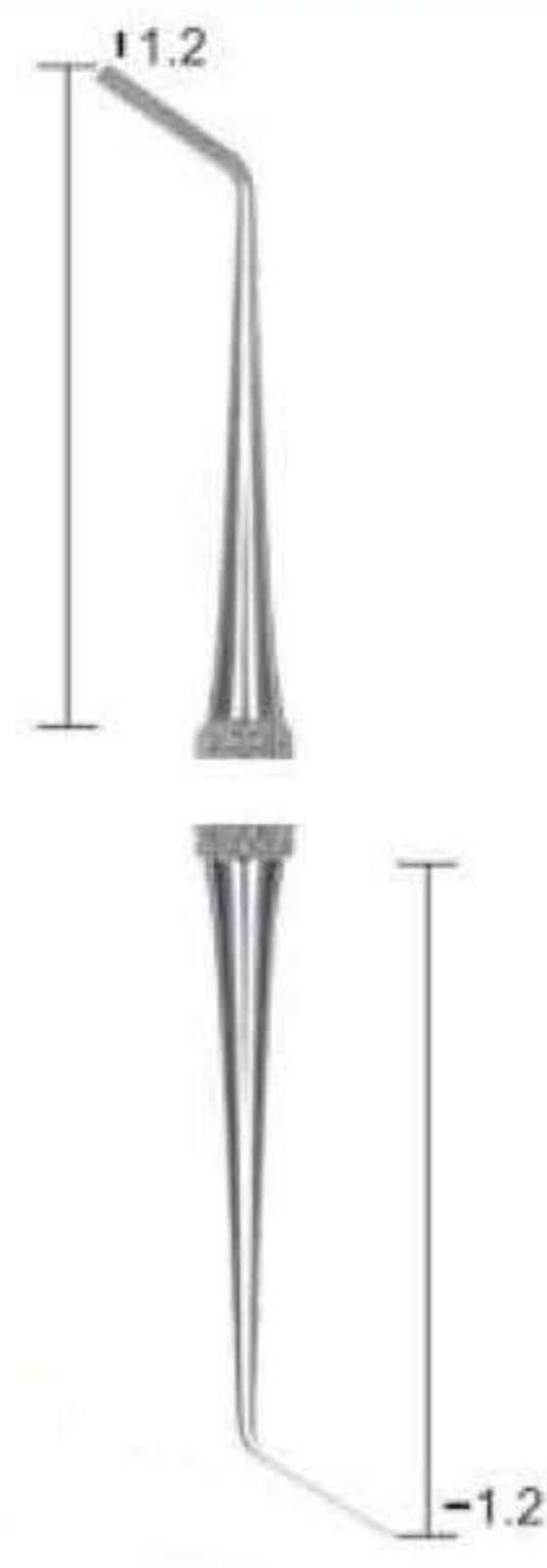

**NHS-640**  
5M  
Markley

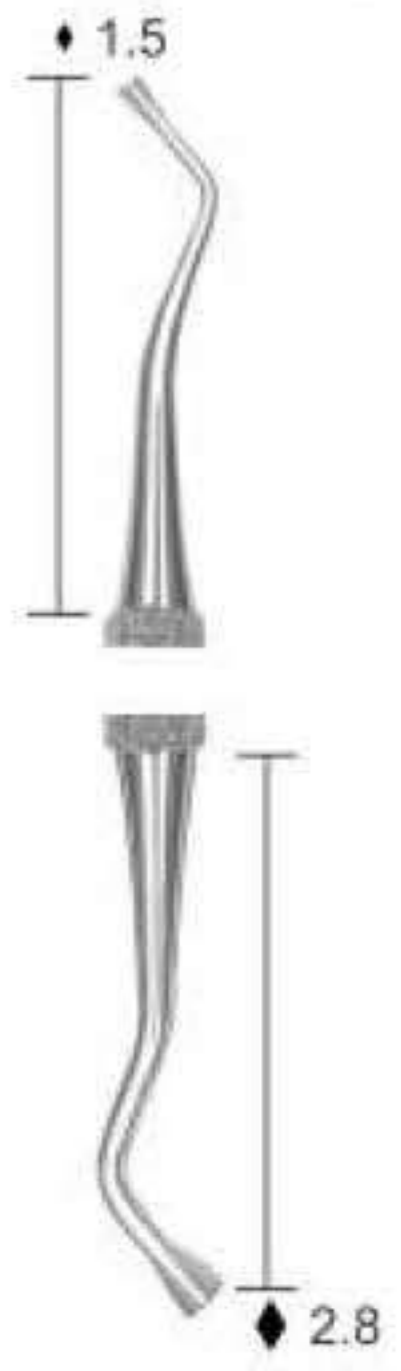

**NHS-641**  
6M  
Markley

## PLUGGERS/CONDENSERS



**NHS-637**  
1M  
Markley



**NHS-642**  
1  
Oregon  
#41, #6



**NHS-643**  
2  
Oregon  
#41, #6



**NHS-644**  
3  
Oregon



**NHS-645**  
4  
Oregon  
#41, #6



**NHS-646**  
1  
Ward

**NHS-647**  
2  
Ward



# FILLING INSTRUMENTS

- Инструменты для реставрации
- Instruments pour plombage
- Füllungsinstrumente (mit Kontrawinkel)

- Інструменти для реставрації
- Instrumentos para obturaciones
- ملء الصكوك

## RESTORATIVE INSTRUMENTS SOLID HANDLE 6MM, LENGTH 170MM

### Tanner Filling Instruments

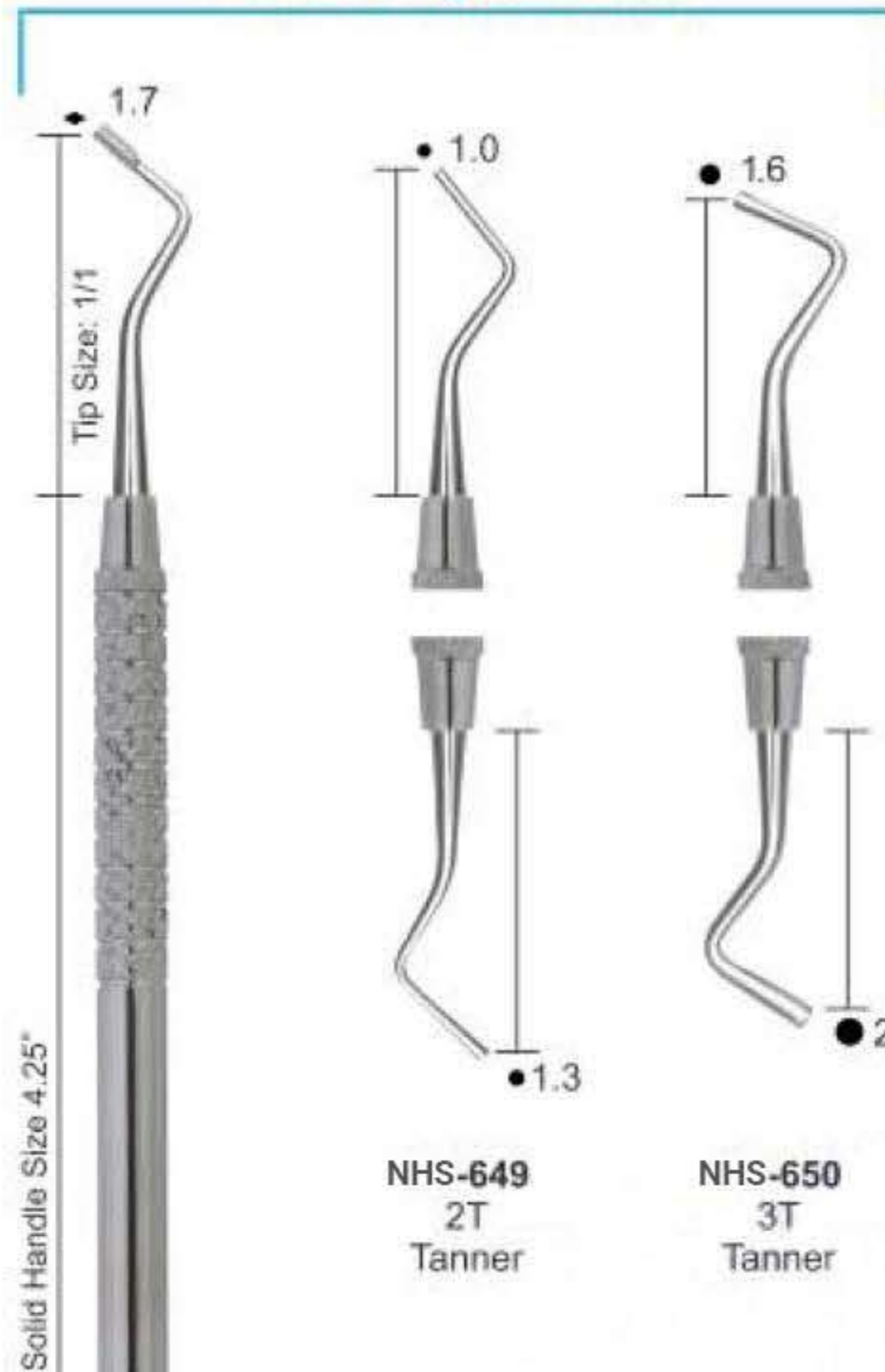

NHS-649  
2T  
Tanner



NHS-650  
3T  
Tanner

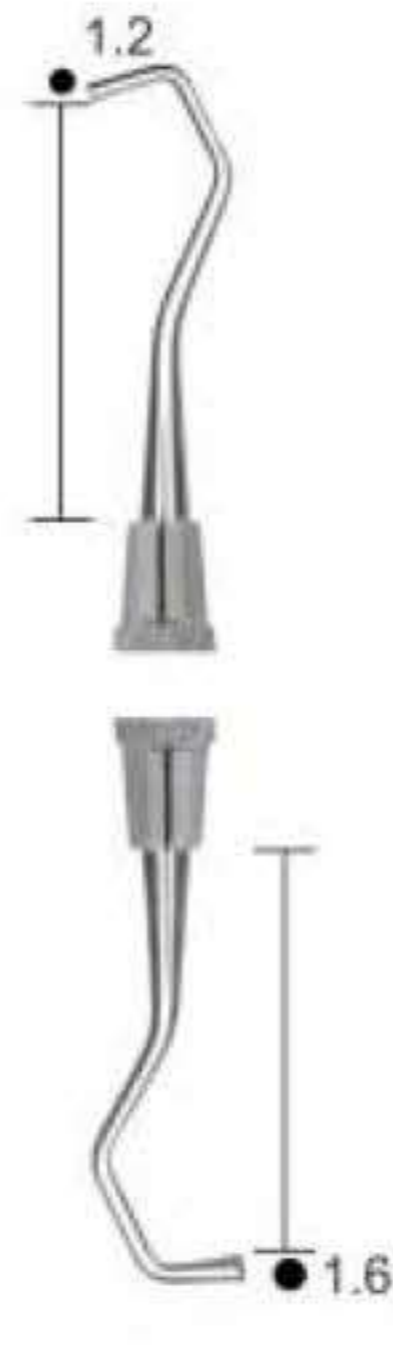

NHS-651  
9/10  
Back Action



NHS-652  
11/12  
Back Action



NHS-653  
153  
English Pattern  
Serrated



NHS-654  
153  
English Pattern  
Serrated

### BURNISHERS

#### BALL

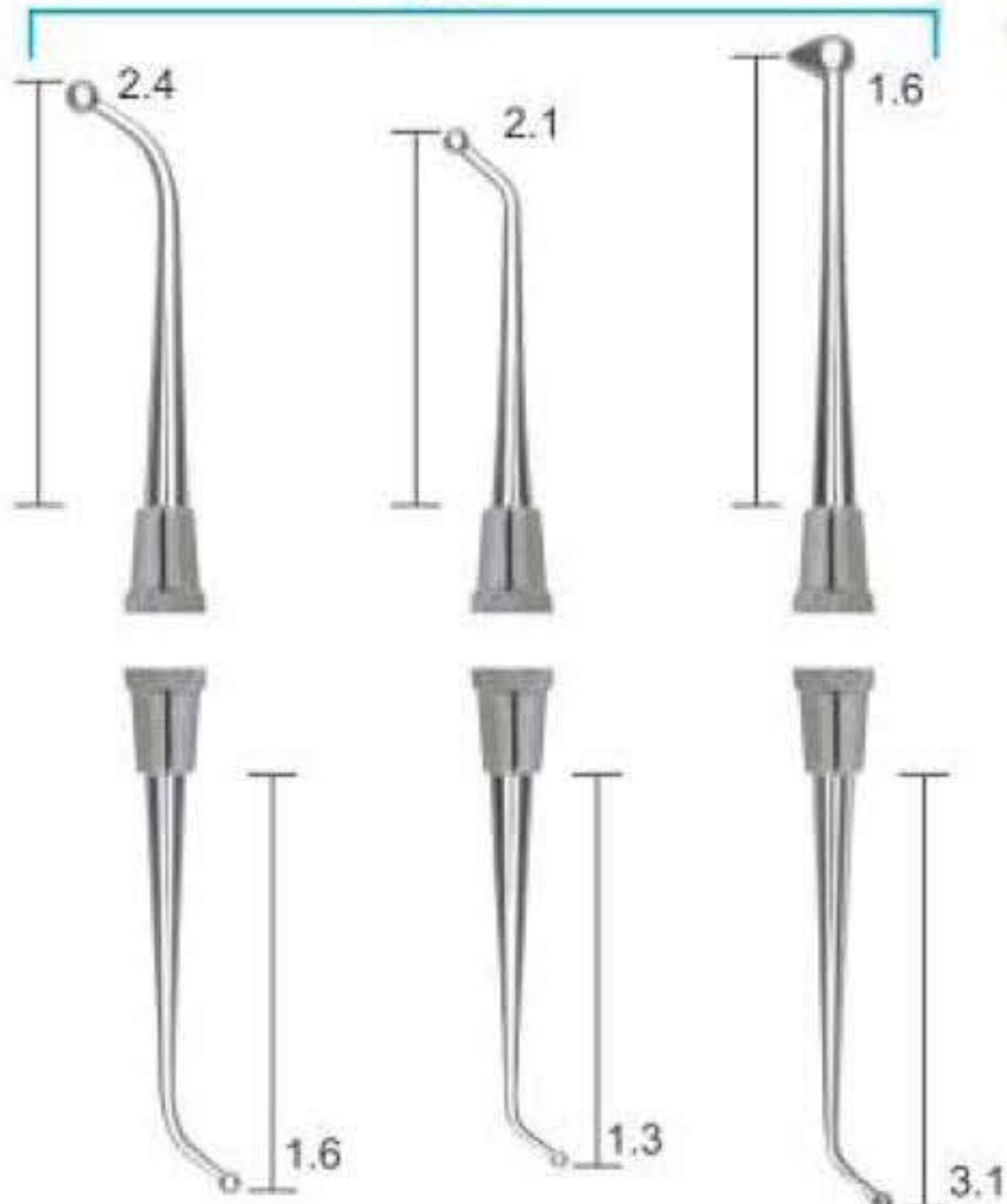

NHS-655  
18  
#41, #6

NHS-656  
26/27S  
#41, #6

NHS-657  
27/28  
#41, #6, #7, #8

#### BEAVERTAIL



DE-658  
2

NHS-659  
2  
Double-End

#### ACORN



BSI-660  
21  
#41, #6

NHS-661  
21B  
#41, #6, #8

#### LADMORE



NHS-662  
2  
Ladmore

NHS-648  
1T  
Tanner

INCHES  
0  
1  
2  
3  
4  
5  
6  
7  
8  
9



- Инструменты для реставрации
- Instruments pour plomage
- Füllungsinstrumente (mit Kontrawinkel)
- Инструменти для реставрації
- Instrumentos para obturaciones
- ملء الصكوك

## RESTORATIVE INSTRUMENTS SOLID HANDLE 6MM, LENGTH 170MM

### BURNISHERS

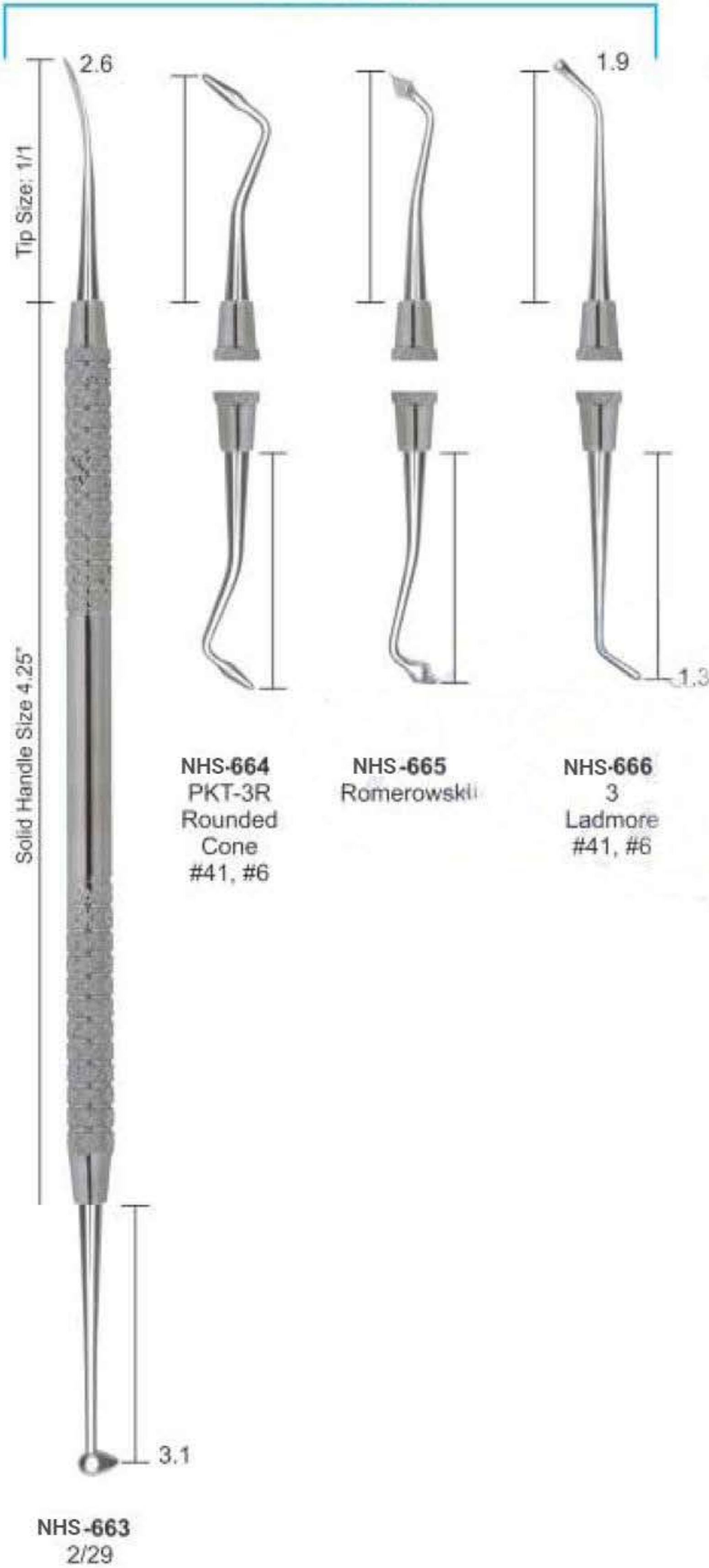

### PERIODONTAL FILES

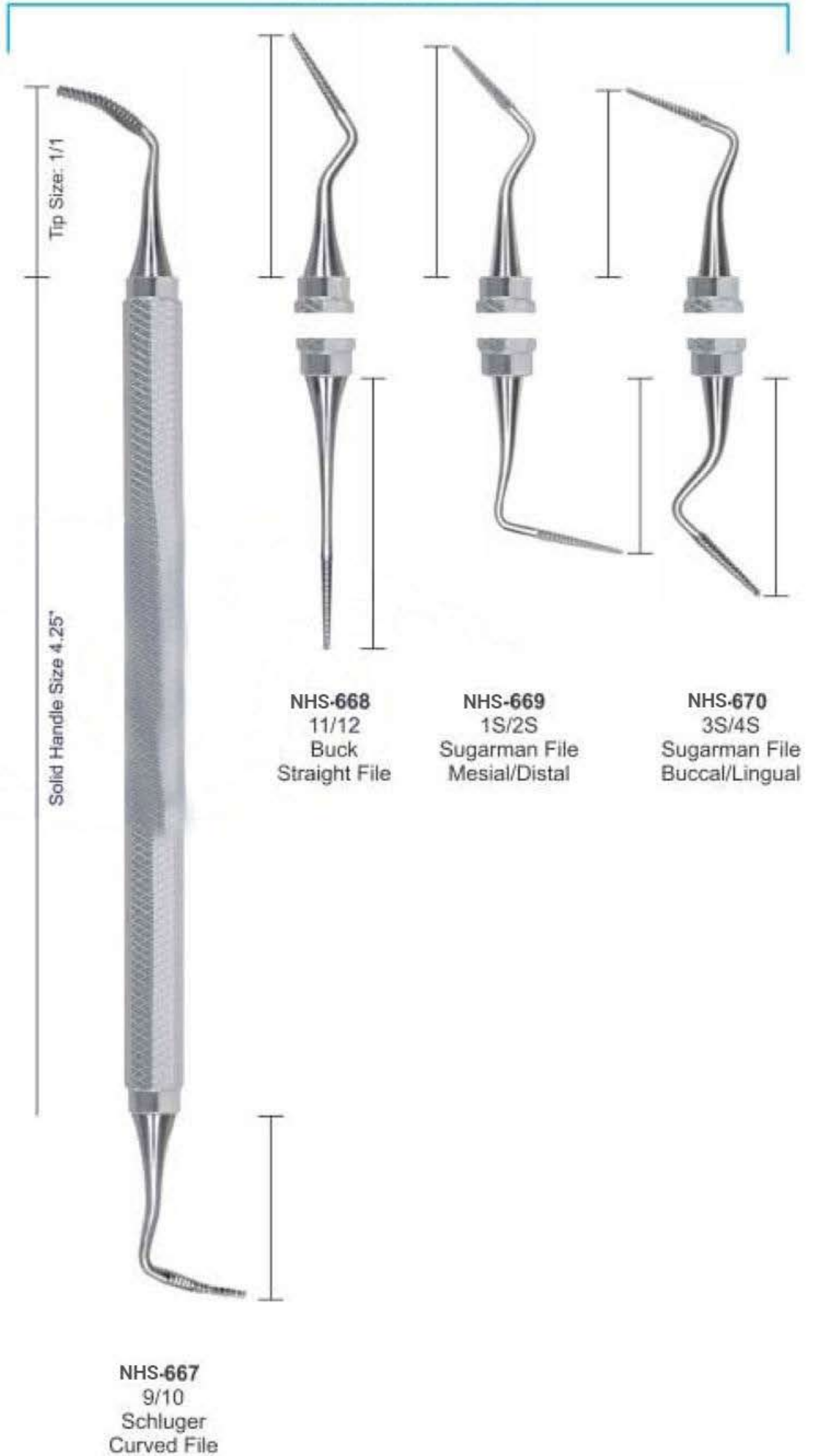



# FILLING INSTRUMENTS

- Инструменты для реставрации
  - Instruments pour plombage
  - Füllungsinstrumente (mit Kontrawinkel)
- Інструменти для реставрації
  - Instrumentos para obturaciones
  - ملء الصكوك

## BURNISHER FILLING INSTRUMENTS

COMPOSITE/PLASTIC FILLING INSTRUMENTS  
SOLID HANDLE 6MM, LENGTH 170MM

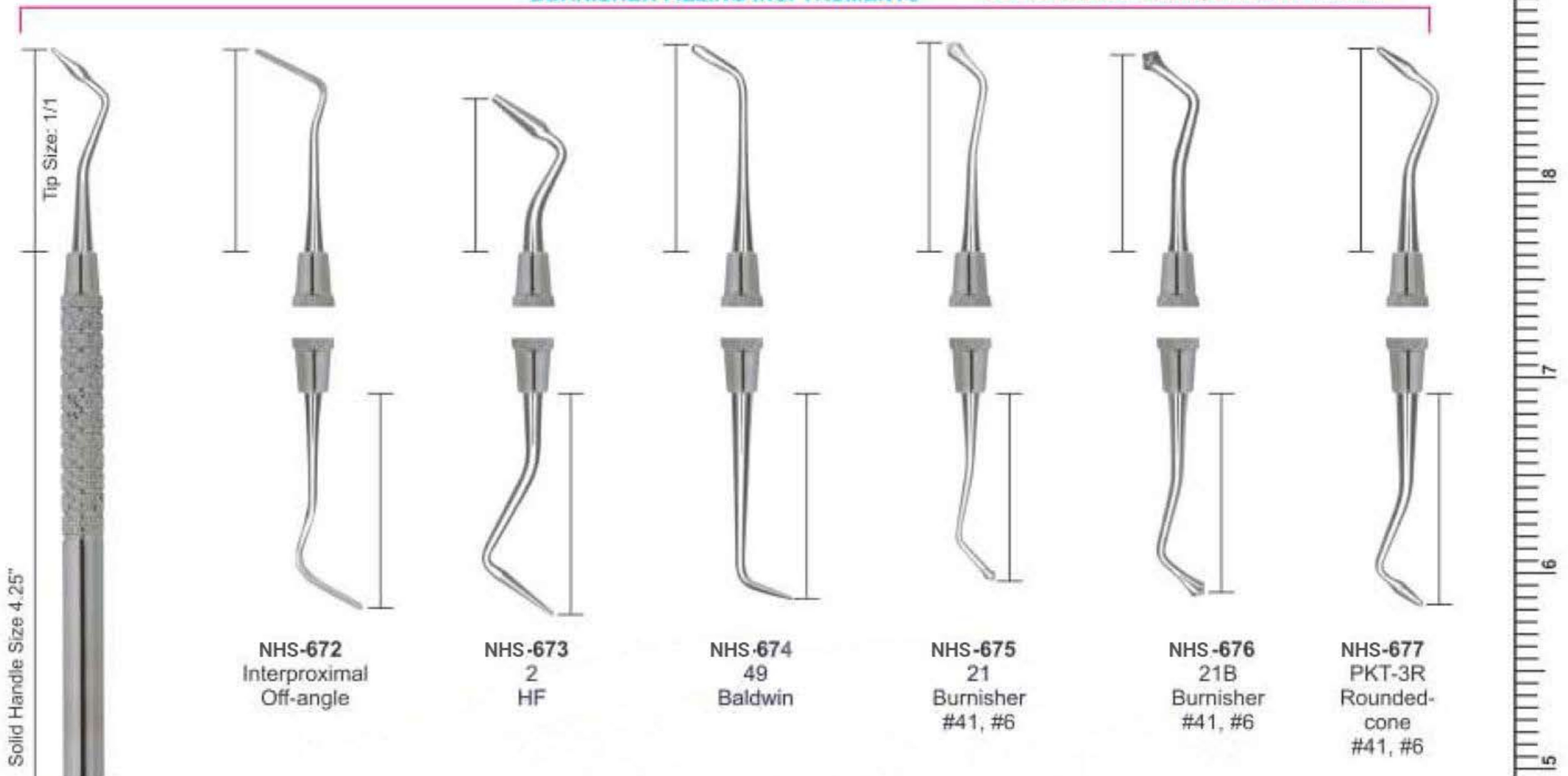

## UNIVERSAL FILLING INSTRUMENTS

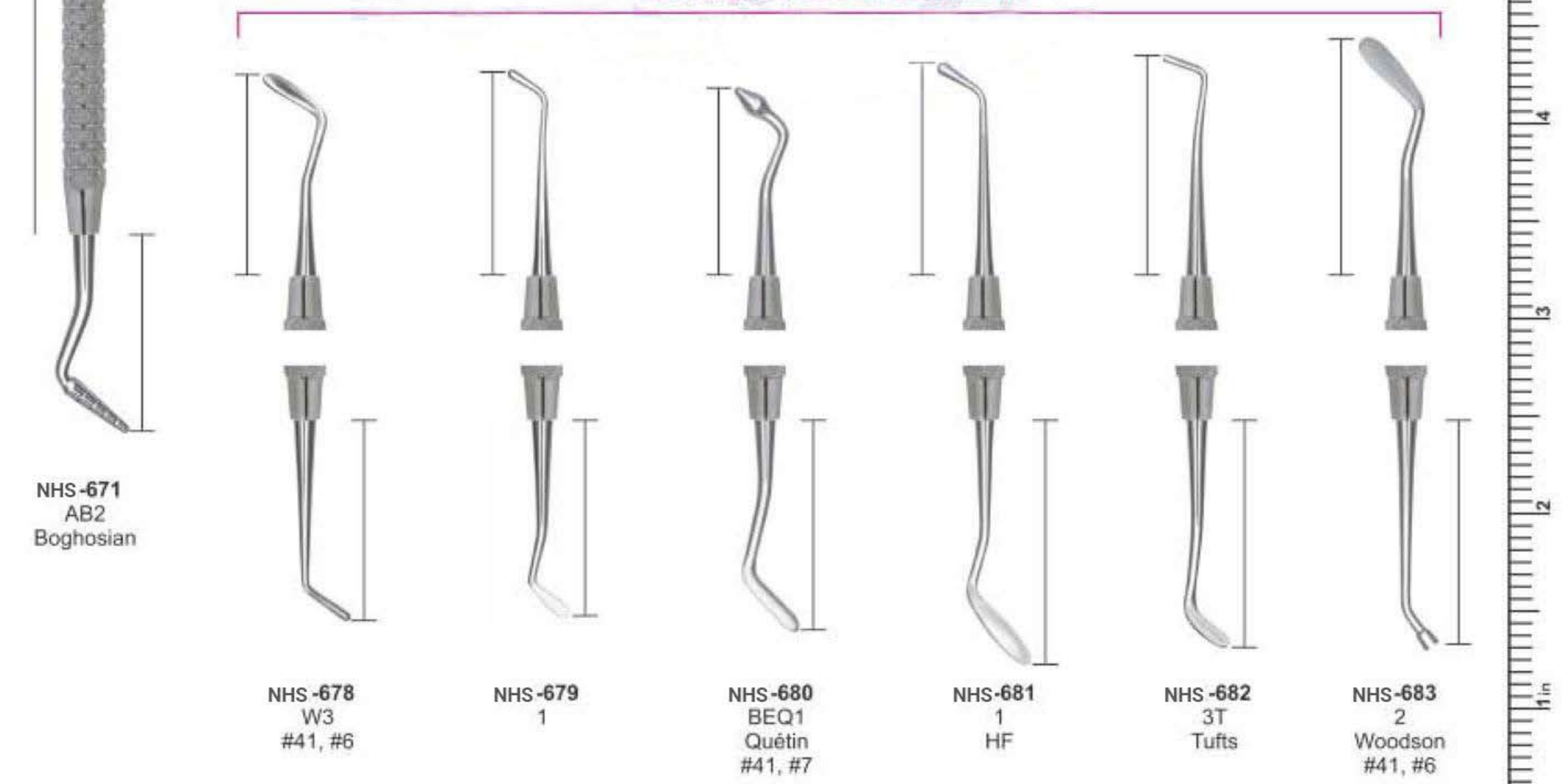







# AMALGAM CARVERS

- Инструменты для реставрации
- Instruments pour amalgame
- Amalgampistolen
- Інструменти для реставрації
- instrumentos para amalgama
- تقطیع الملغم

## AMALGAM INSTRUMENTS SOLID HANDLE 6MM, LENGTH 170MM







- Инструменты для реставрации
- Instruments pour amalgame
- Amalgampistolen

- Инструменти для реставрації
- instrumentos para amalgame
- تقطيع الملقم

## AMALGAM INSTRUMENTS SOLID HANDLE 6MM, LENGTH 170MM

### Excavators Instruments Set of 11 Pieces

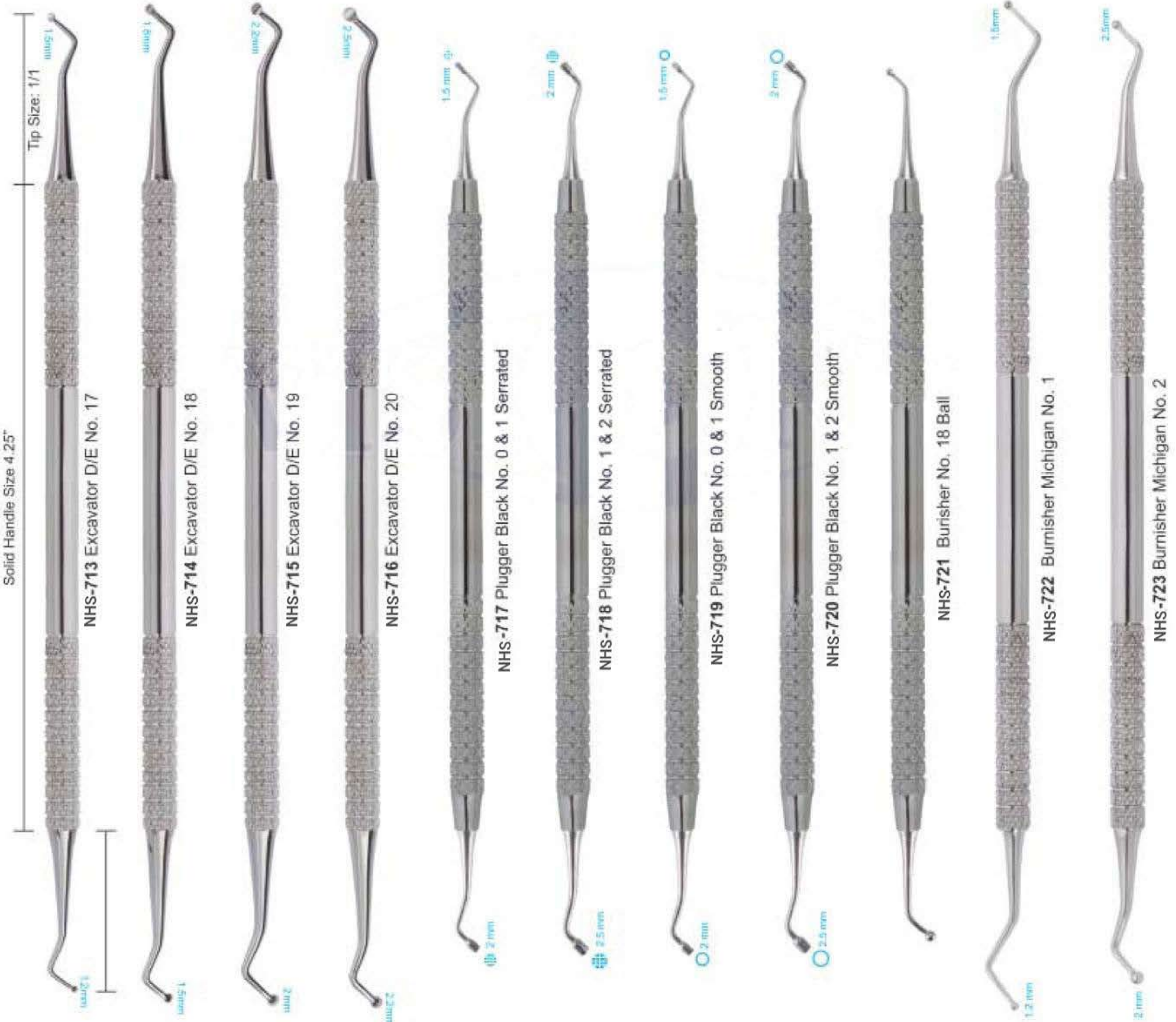
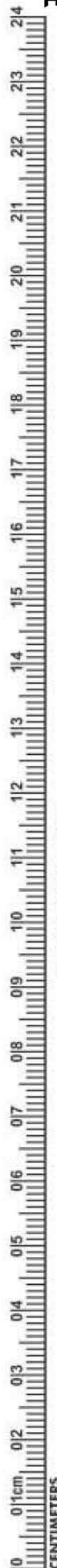



# PERIODONTAL INSTRUMENTS

- Инструменты пародонтологические
  - Instruments pour la parodontologie
  - Instrumente für die Parodontologie
- Инструменти пародонтологічні
  - instrumentos para periodoncía
  - الصكوك الثلاثة

## SICKLE SCALERS INSTRUMENTS SOLID HANDLE 6MM, LENGTH 170MM

### SICKLE SCALERS

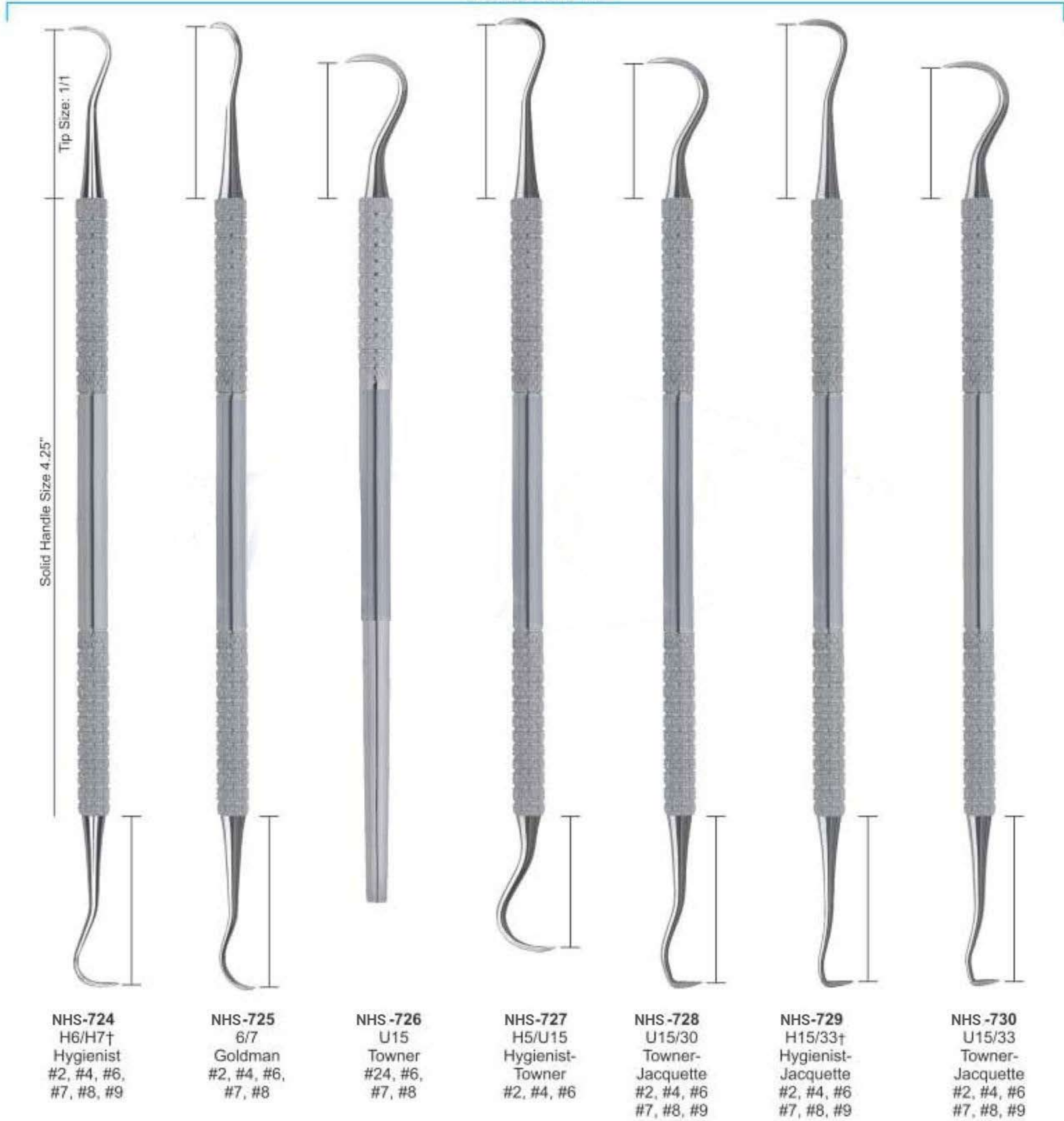

INCHES  
0  
1  
2  
3  
4  
5  
6  
7  
8  
9



- Инструменты пародонтологические
- Instruments pour la parodontologie
- Instrumente für die Parodontologie

- Інструменти пародонтологічні
- instrumentos para periodoncia
- المسكوك اللثة

PERIODONTAL INSTRUMENTS SOLID HANDLE 6MM, LENGTH 170MM

JACQUETTE SCALERS

CRANE-KAPLAN

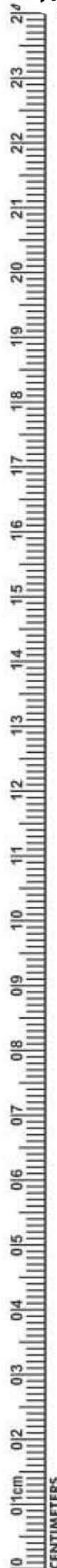

**NHS-731**  
30/33  
Hygienist  
Jacquette  
#2, #4, #6,  
#7, #8, #9

**NHS-732**  
31/32  
Jacquette  
#2, #4, #6,  
#7, #8, #9

**NHS-733**  
34/35  
Jacquette  
#2, #4, #6,  
#7, #8, #9

**NHS-734**  
H3/H4  
Jacquette  
#2, #4, #6,

**NHS-735**  
14/15  
Posterior  
Jacquette  
#2, #4, #6,

**NHS-736**  
CK-6  
#2, #4, #6,



# PERIODONTAL INSTRUMENTS

- Инструменты пародонтологические
- Instruments pour la parodontologie
- Instrumente für die Parodontologie
- Інструменти пародонтологічні
- instrumentos para periodoncía
- الصكوك اللثة

## PERIODONTAL INSTRUMENTS SOLID HANDLE 6MM, LENGTH 170MM SCALER/CURETTE SETS







- Кюрети
  - Curetas
  - Küretten
- Кюрети
  - Curette
  - كرتس

**SCALER/CURETTE SETS**

**GOLDMAN-FOX SET**

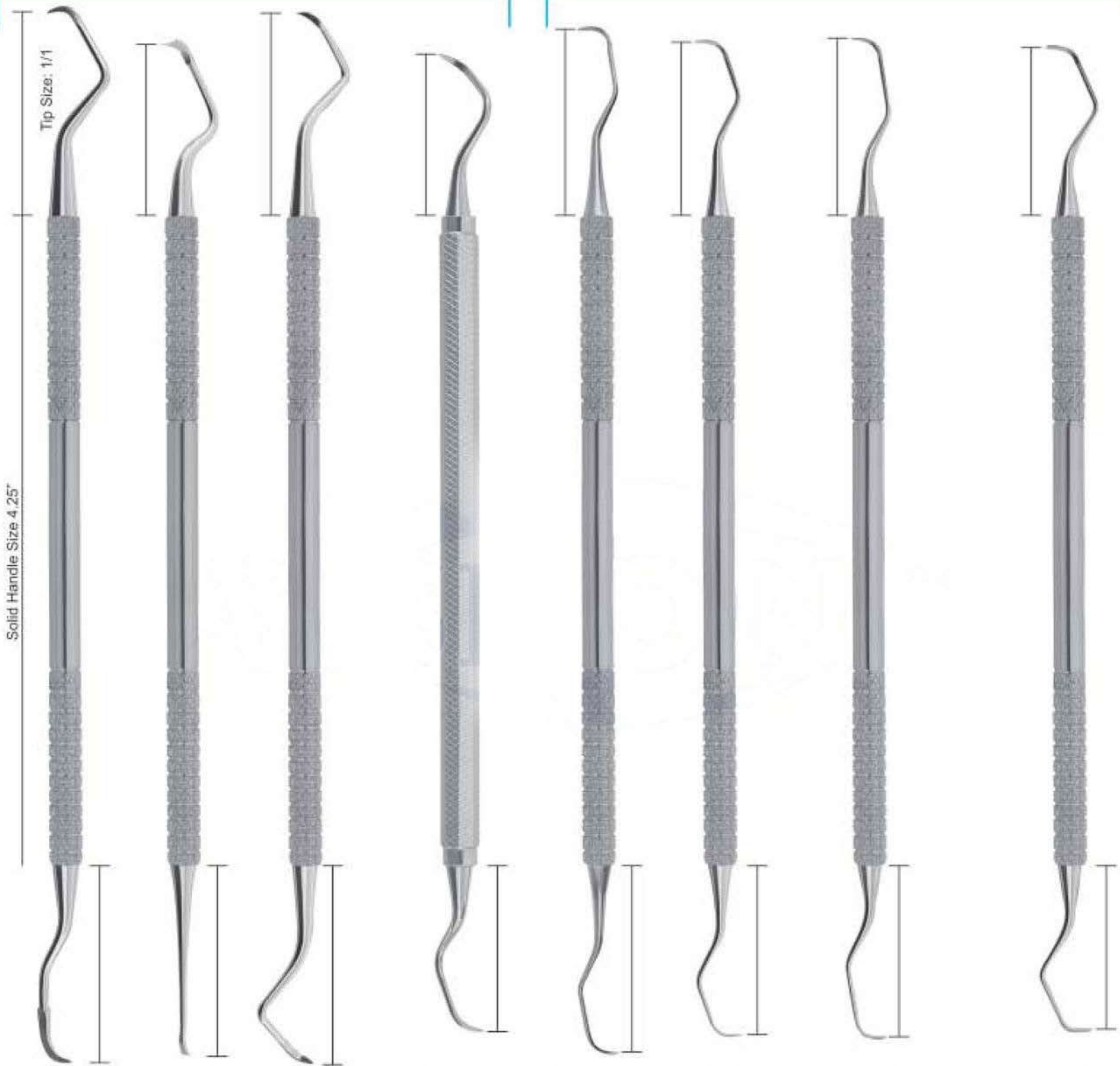
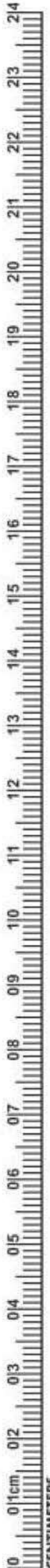

**NHS-744**  
103/106  
#4, #6

**NHS-744A**  
104/105  
Hoe/Chisel  
#4, #6

**NHS-745**  
107/108  
#2, #4, #6  
#7, #8

**NHS-746**  
107/108S  
Modied  
#2, #4

**NHS-747**  
1/2  
(shown)  
#2, #4, #6  
#7, #8, #9

**NHS-749**  
3/4†  
(shown)  
#2, #4, #6  
#7, #8, #9

**NHS-751**  
5/6†  
(shown)  
#2, #4, #6  
#7, #8, #9

**NHS-754**  
7/8†  
(shown)  
#2, #4, #6  
#7, #8, #9

**NHS-748**  
1/2  
Rigid  
#2, #4, #6  
#7, #8, #9

**NHS-750**  
3/4  
Rigid  
#2, #4, #6  
#7, #8, #9

**NHS-752**  
5/6  
Rigid  
#2, #4, #6  
#7, #8, #9

**NHS-753**  
5/6  
Extra Rigid  
#4, #6 #7,  
#8

**NHS-755**  
7/8  
Rigid  
#2, #4, #6  
#7, #8, #9

**NHS-756**  
7/8  
Extra Rigid  
#2, #4, #6  
#7, #8, #9

**SCALER/CURETTE SETS INSTRUMENTS  
SOLID HANDLE 6MM, LENGTH 170MM**



# CURETTES

- Кюрети
- Curetas
- Küretten
- Кюрети
- Curette
- كرتس

**GRACEY CURETTE INSTRUMENTS SOLID HANDLE 6MM, LENGTH 170MM**  
**GRACEY CURETTES**

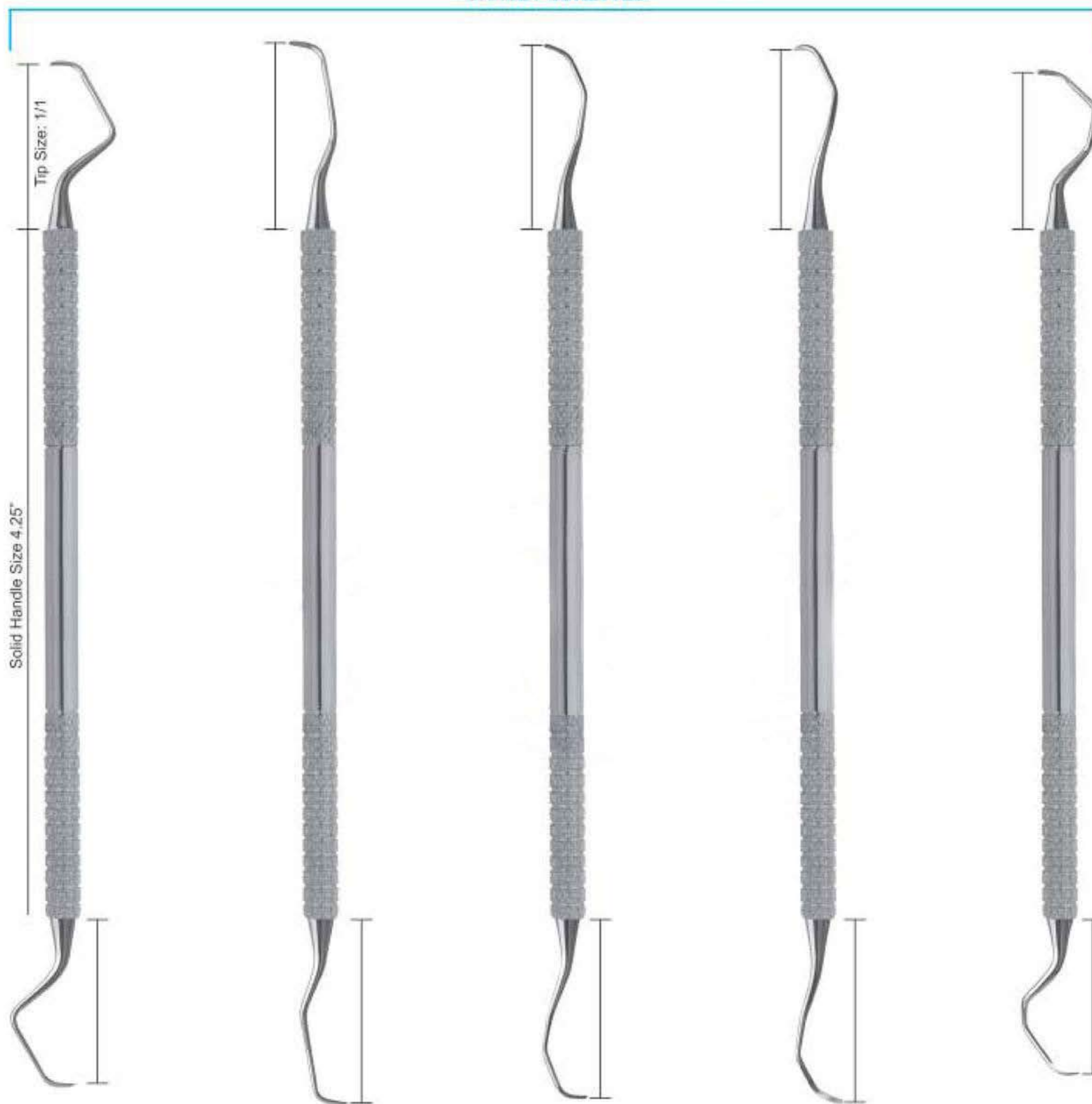

**NHS-757**  
9/10†  
(shown)  
#2, #4, #6  
#7, #8, #9

**NHS-759**  
11/12†  
(shown)  
#2, #4, #6  
#7, #8, #9

**NHS-792**  
13/14†  
(shown)  
#2, #4, #6  
#7, #8, #9

**NHS-765**  
15/16†  
(shown)  
#2, #4, #6  
#7, #8, #9

**NHS-767**  
17/18  
#2, #4, #6  
#7, #8, #9

**NHS-758**  
9/10  
Rigid  
#2, #4, #6  
#7, #8

<b>NHS-760</b> 11/12 Rigid #2, #4, #6 #7, #8, #9	<b>NHS-761</b> 11/12 Extra Rigid #4, #6 #7, #8
--------------------------------------------------------------	------------------------------------------------------------

<b>NHS-793</b> 13/14 Rigid #2, #4, #6 #7, #8, #9	<b>NHS-764</b> 13/14 Extra Rigid #4, #6 #7, #8
--------------------------------------------------------------	------------------------------------------------------------

**NHS-766**  
15/16  
Rigid  
#2, #4, #6  
#7, #8, #9

**NHS-768**  
17/18  
Rigid  
#2, #4, #6  
#7, #8, #9

INCHES



- Кюрети
  - Curetas
  - Küretten
- Кюрети
  - Curette
  - کرتس

**CURETTE INSTRUMENTS  
HOLLOW HANDLE 8.5MM, LENGTH 170MM**

**CURETTE INSTRUMENTS  
SOLID HANDLE 6MM, LENGTH 170MM**

**CURETTE INSTRUMENTS  
SOLID HANDLE 6MM, LENGTH 170MM**



**NHS-769**  
Hemingway  
2mm, 2mm

**NHS-770**  
Hemingway  
3mm, 3mm

**NHS-771**  
Hemingway  
4mm, 4mm

**NHS-772**  
Hemingway  
2mm, 2mm

**NHS-773**  
Hemingway  
3mm, 3mm

**NHS-774**  
Hemingway  
4mm, 4mm

**NHS-775**  
Hemingway  
2mm, 2mm

**NHS-776**  
Hemingway  
3mm, 3mm

**NHS-777**  
Hemingway  
4mm, 4mm



# EXCAVATORS

- Экскаваторы
- Excavateurs
- Excavatoren
- Екскаватори
- Excavadores
- حفارات

## EXCAVATORS INSTRUMENTS SOLID HANDLE 6MM, LENGTH 170MM SPOONS

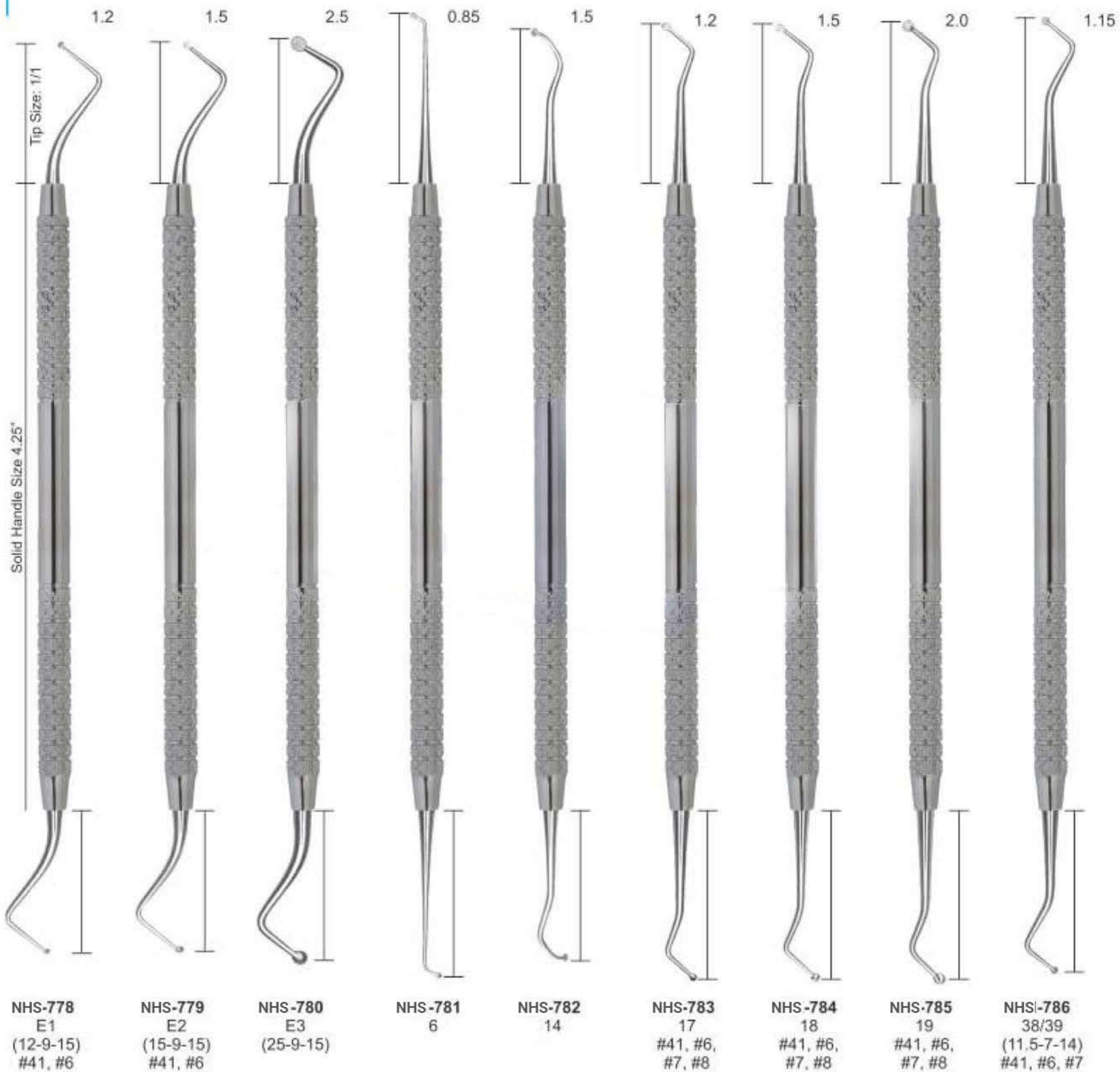



- Экскаваторы
- Excavateurs
- Excavatoren
- Экскаватори
- Excavadores
- حفارات

**EXCAVATORS INSTRUMENTS**  
SOLID HANDLE 6MM, LENGTH 170MM

**OVAL SPOONS/DARBY-PERRY**

**EXCAVATORS**

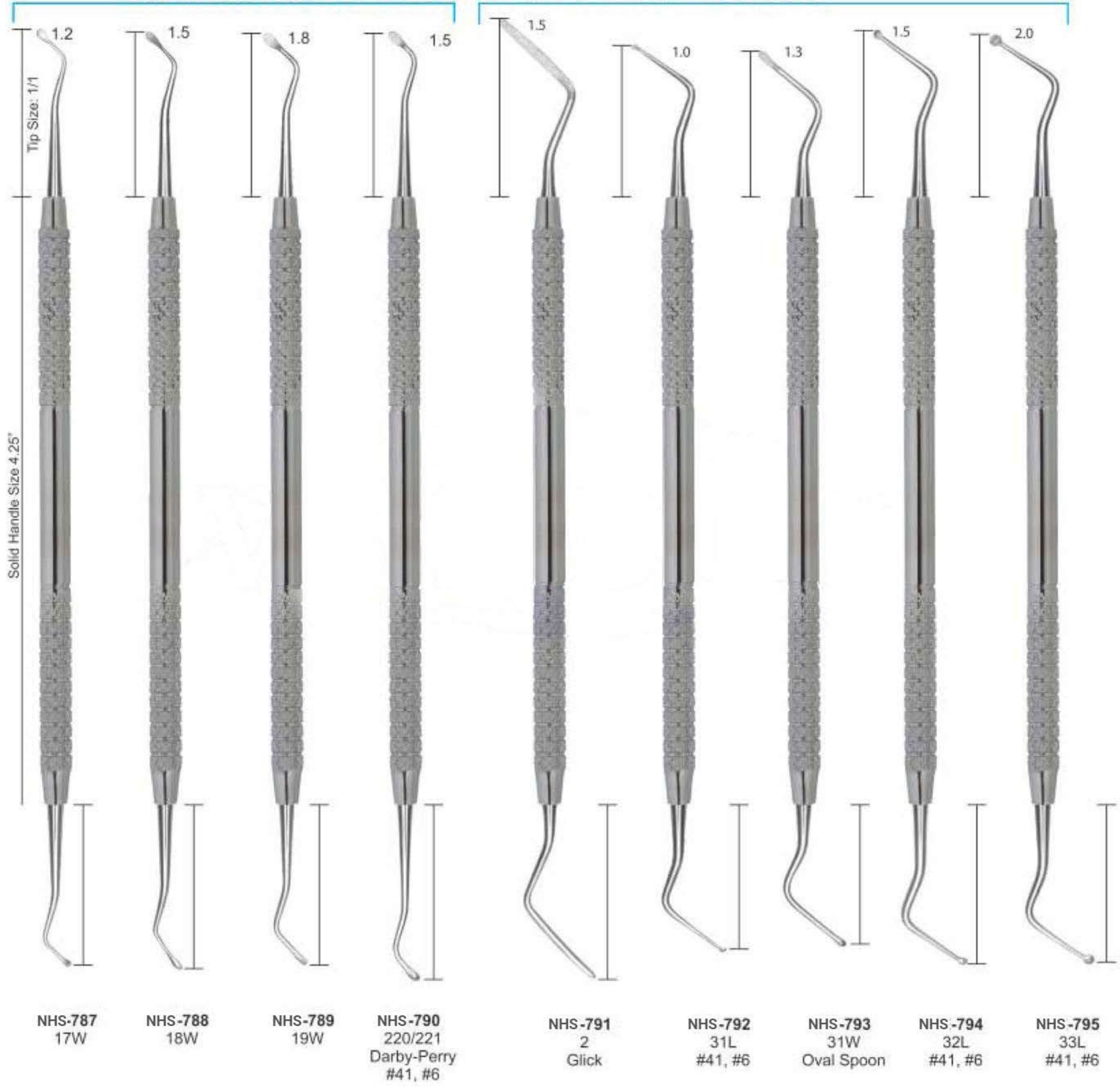
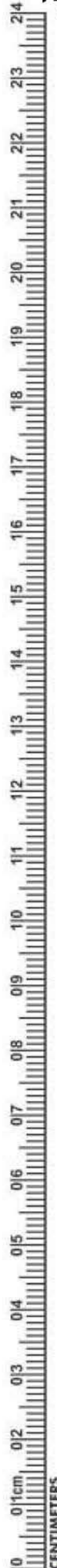



# EXCAVATORS

- Экскаваторы
- Excavateurs
- Excavatoren
- Екскаватори
- Excavadores
- حفارات

## EXCAVATORS INSTRUMENTS SOLID HANDLE 6MM, LENGTH 170MM

### BLADES

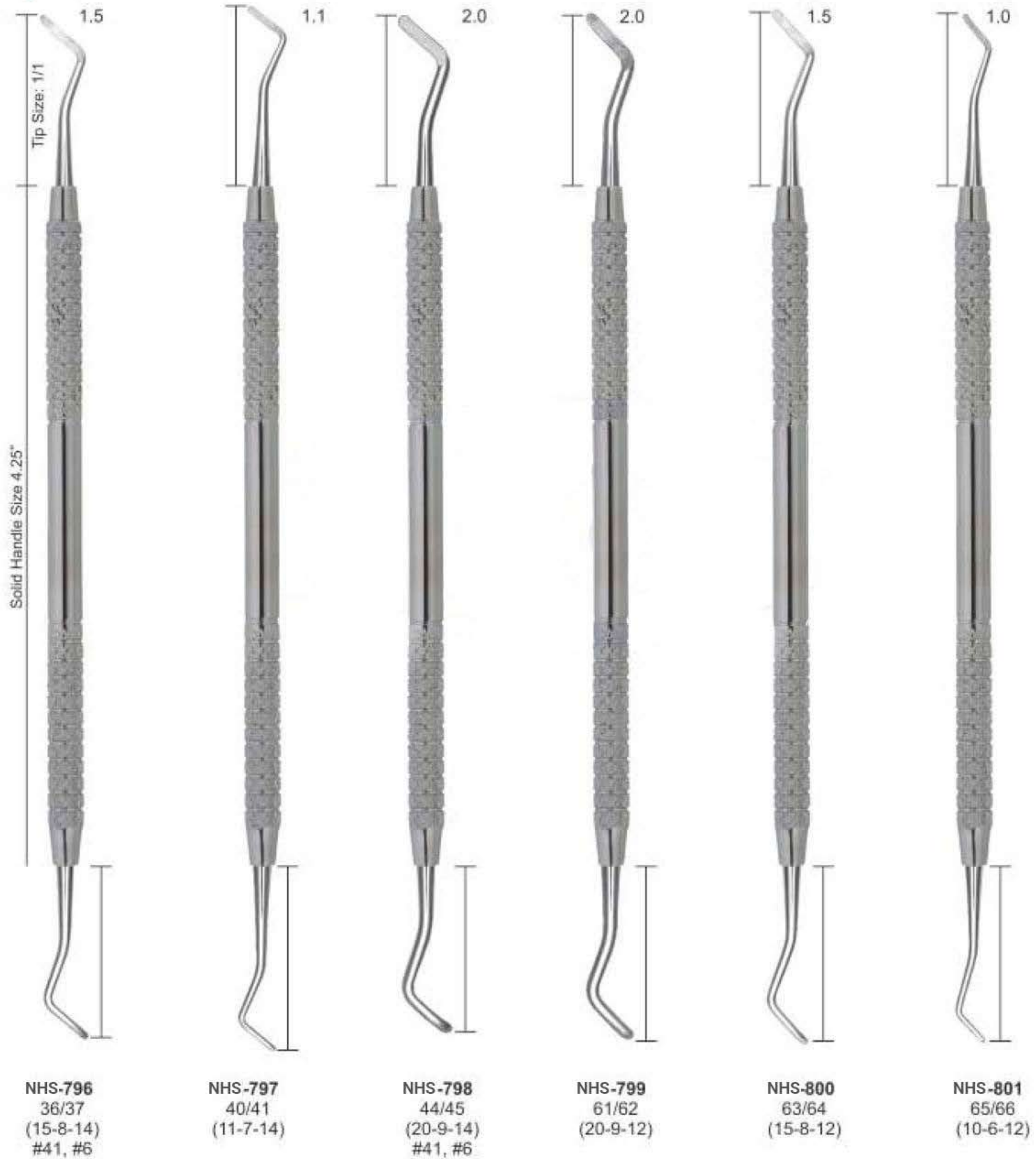





- Экскаваторы
- Excavateurs
- Excavatoren
- Экскаватори
- Excavadores
- حفارات

## EXCAVATORS INSTRUMENTS SOLID HANDLE 6MM, LENGTH 170MM

## ENGLISH PATTERNS

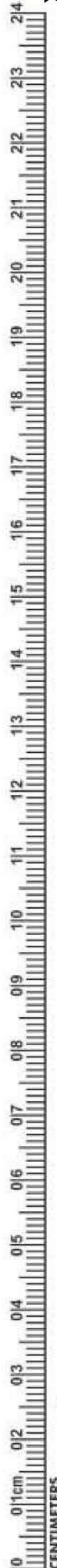

NHS-802 Goldstein Interproximal Excavator	NHS-803 243	NHS-804 244	NHS-805 245	NHS-806 246	NHS-807 125/126 #41, #6	NHS-808 127/128 #41, #6	NHS-809 129/130 #41, #6	NHS-810 131/132 #41, #6	NHS-811 153/154
----------------------------------------------------	----------------	----------------	----------------	----------------	-------------------------------	-------------------------------	-------------------------------	-------------------------------	--------------------



# FILLING INSTRUMENTS

- Инструменты для реставрации
- Instruments pour plombage
- Füllungsinstrumente (mit Kontrawinkel)
- Інструменти для реставрації
- Instrumentos para obturaciones
- ملء الصكوك

## HATCHETS

## RESTORATIVE INSTRUMENTS SOLID HANDLE 6MM, LENGTH 170MM

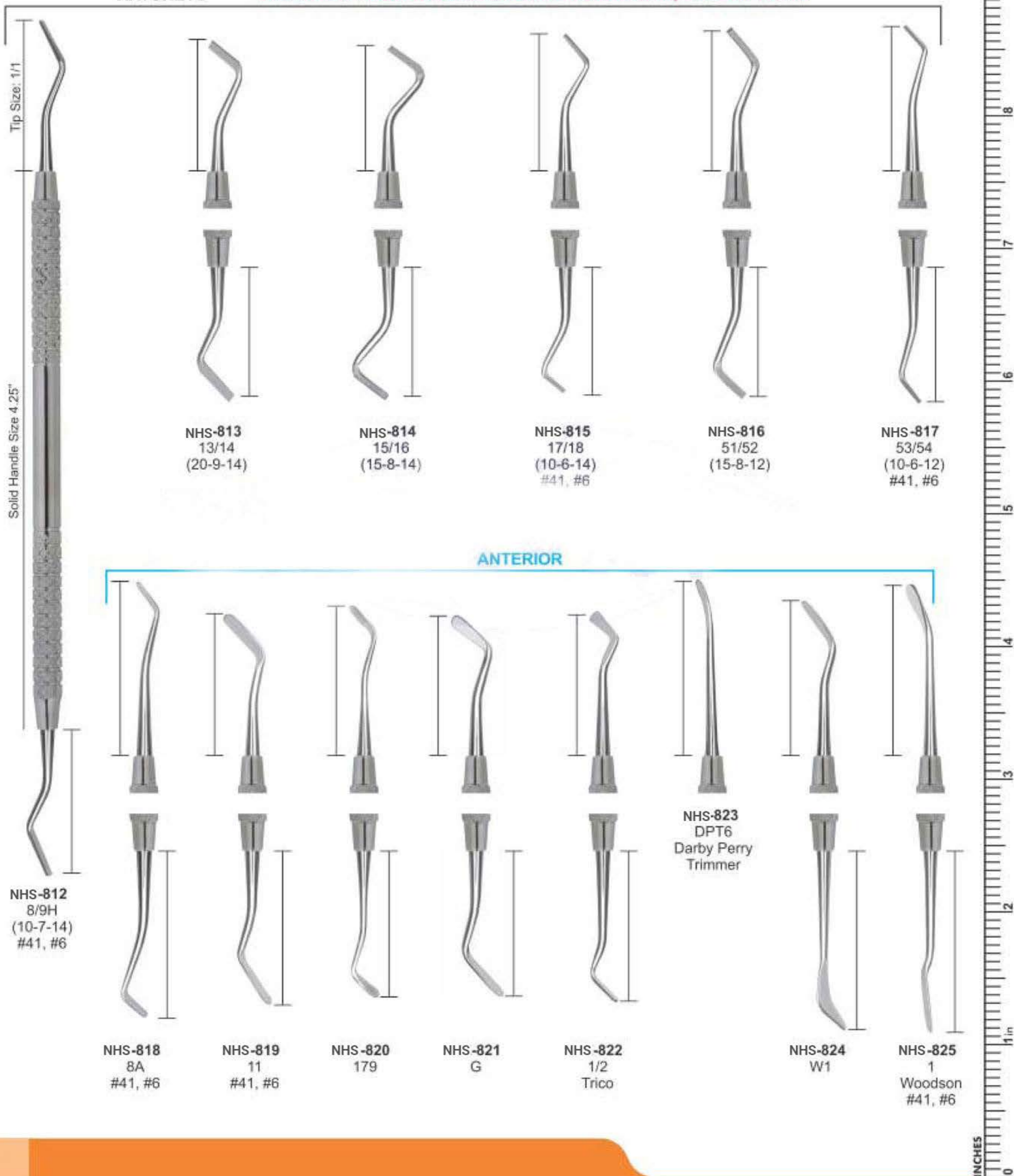





- Инструменты для реставрации
- Instruments pour plombage
- Füllungsinstrumente (mit Kontrawinkel)
- Инструменти для реставрації
- Instrumentos para obturaciones
- ملء الصكوك

## CARVERS

## RESTORATIVE INSTRUMENTS SOLID HANDLE 6MM, LENGTH 170MM

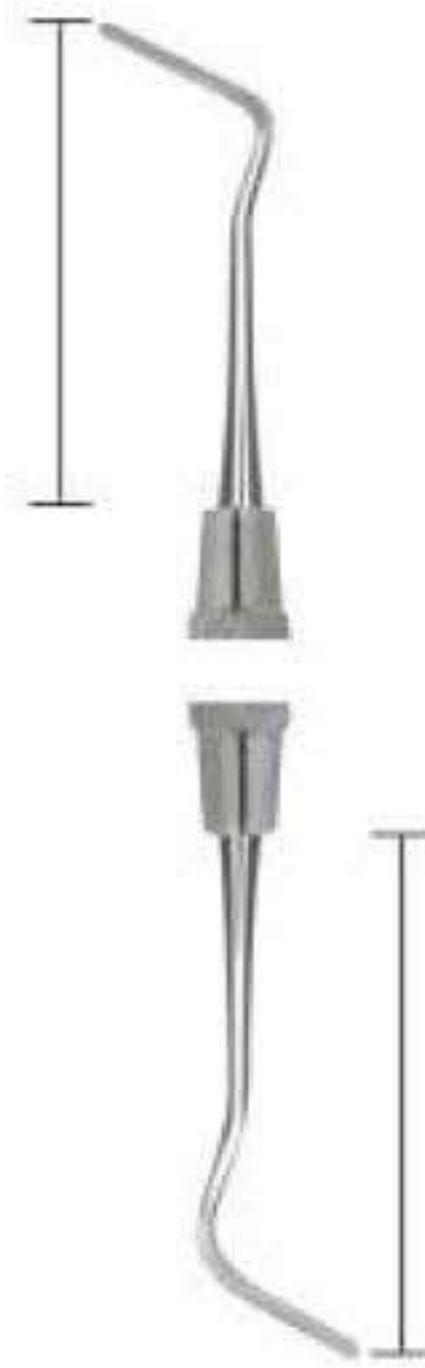
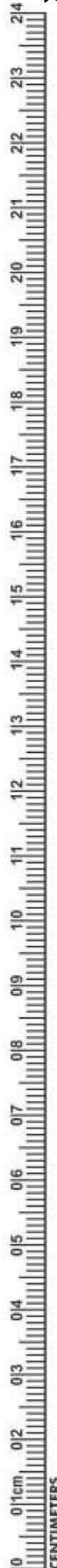

NHS-827 Inter-proximal Off-Angle



NHS-828 1/2-3 Hollenback #41, #6, #7, #8



NHS-829 3S Hollenback #41, #6, #7



NHS-830 3 Hollenback



NHS-831 8 Wiland Minn.IPC1 #41, #6, #7

## TANNER

## WALL

## WARD

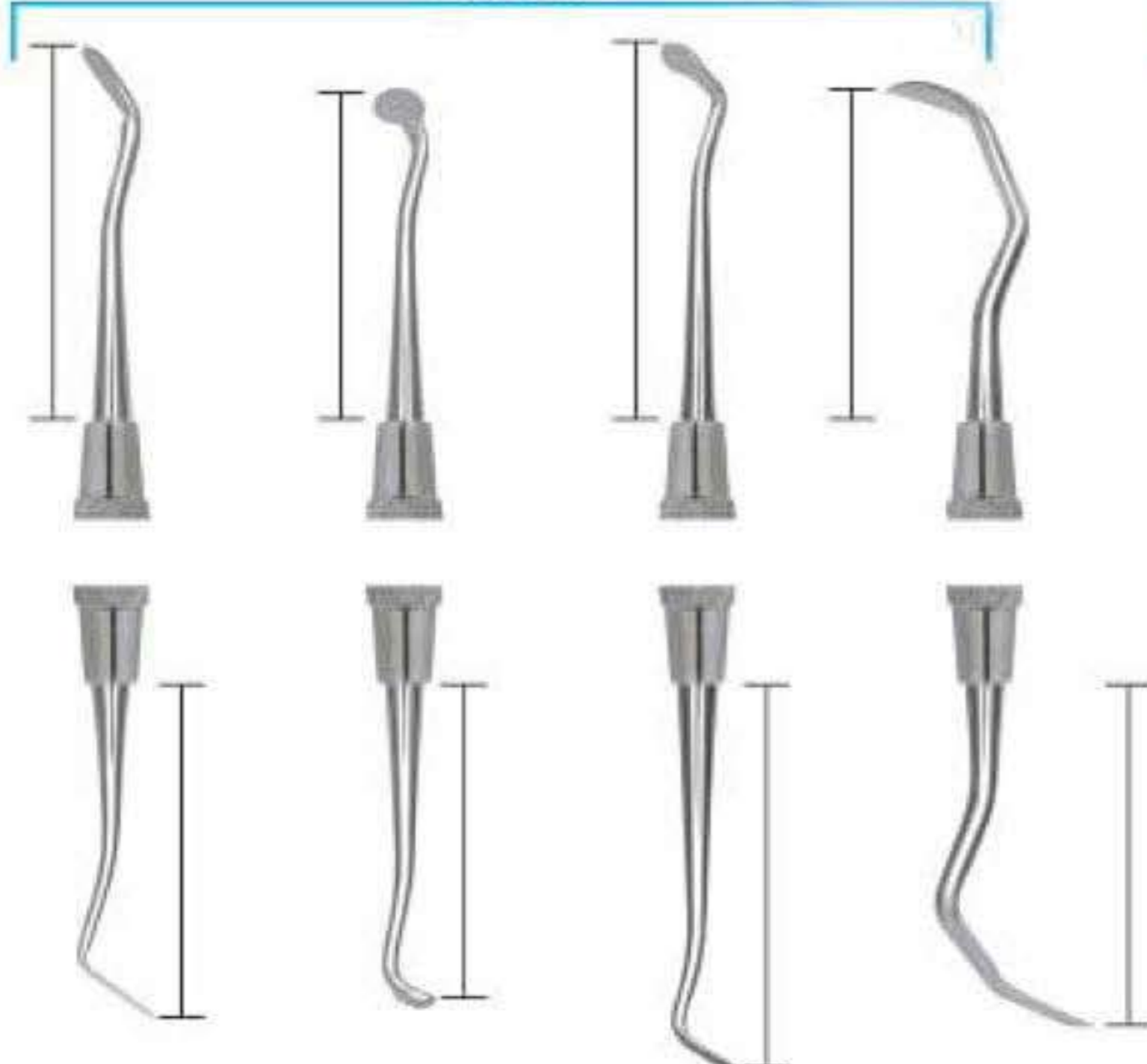

NHS-832 3 Tanner

NHS-833 4 Tanner

NHS-834 5 Tanner

NHS-835 6 Tanner



NHS-836 1 Wall

NHS-837 3 Wall

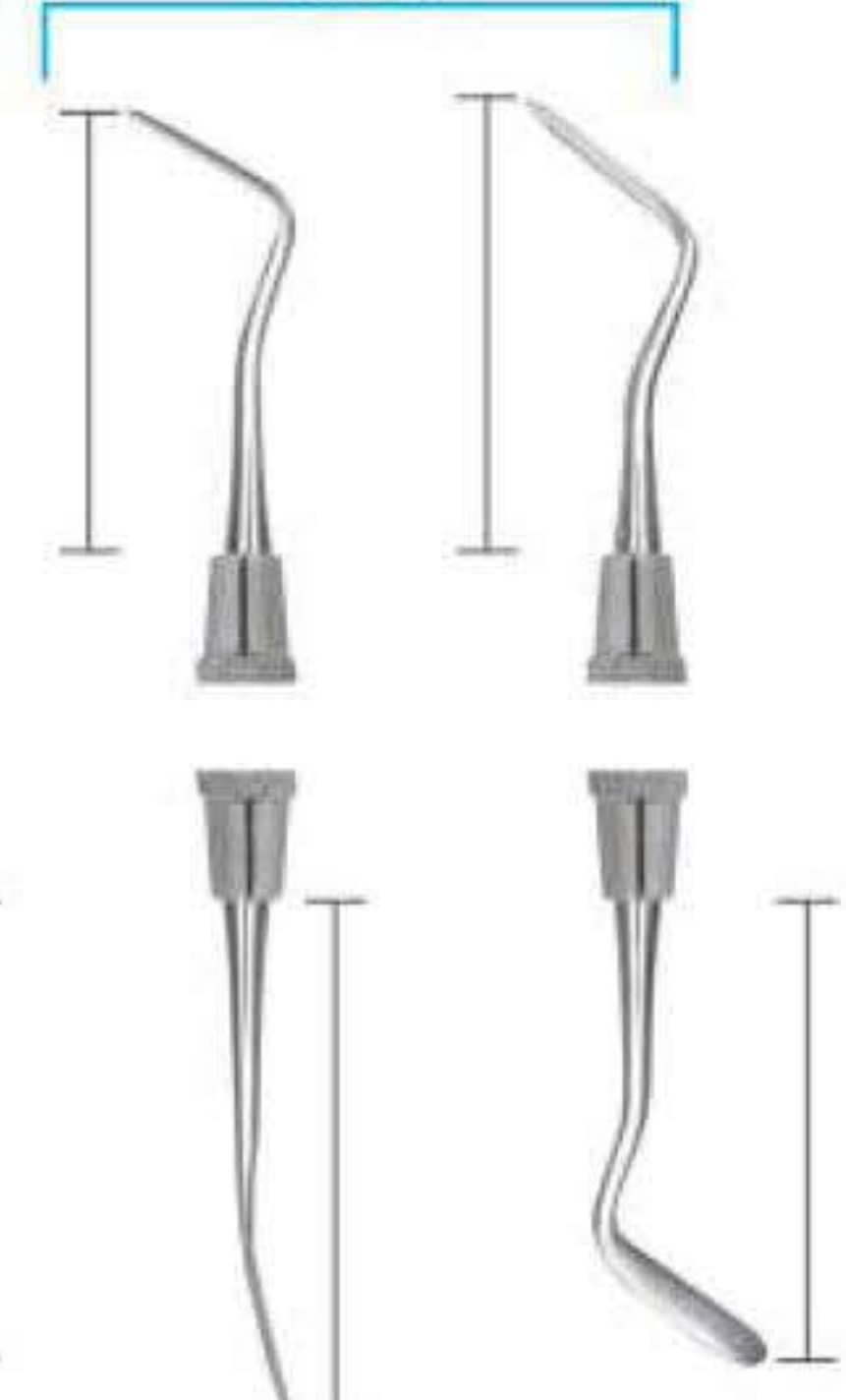

NHS-838 1 Ward

NHS-839 2 Ward

NHS-826 Inter-proximal #41, #6, #7



# AMALGAM CARVERS

- Инструменты для реставрации
- Instruments pour amalgame
- Amalgampistolen
- Інструменти для реставрації
- instrumentos para amalgama
- تقطیع الملغم

## RESTORATIVE INSTRUMENTS

**ANDREW** **SOLID HANDLE 6MM, LENGTH 170MM** **CLAPPISON/FRAHAM**

**HOLLENBACK**

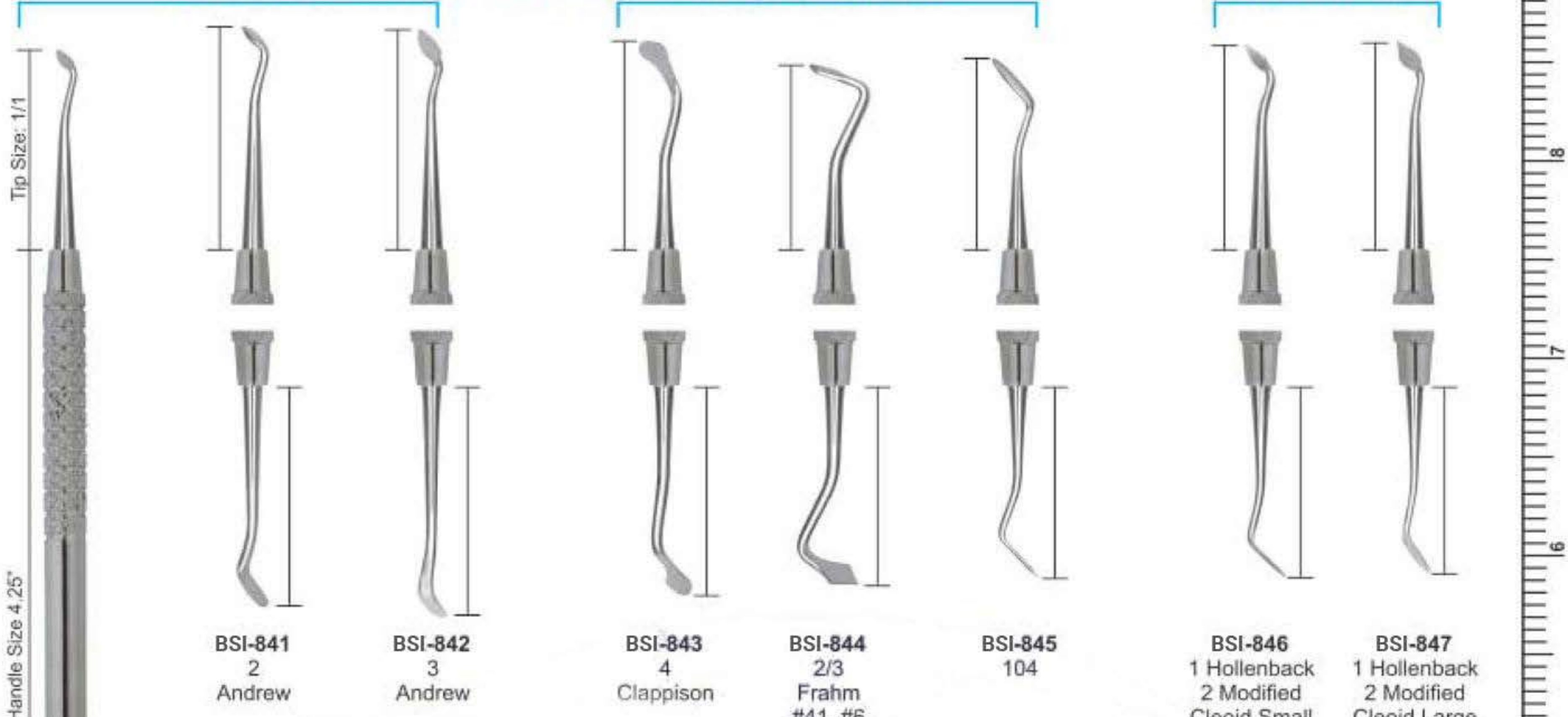

**HOLLENBACK**

**THARP**

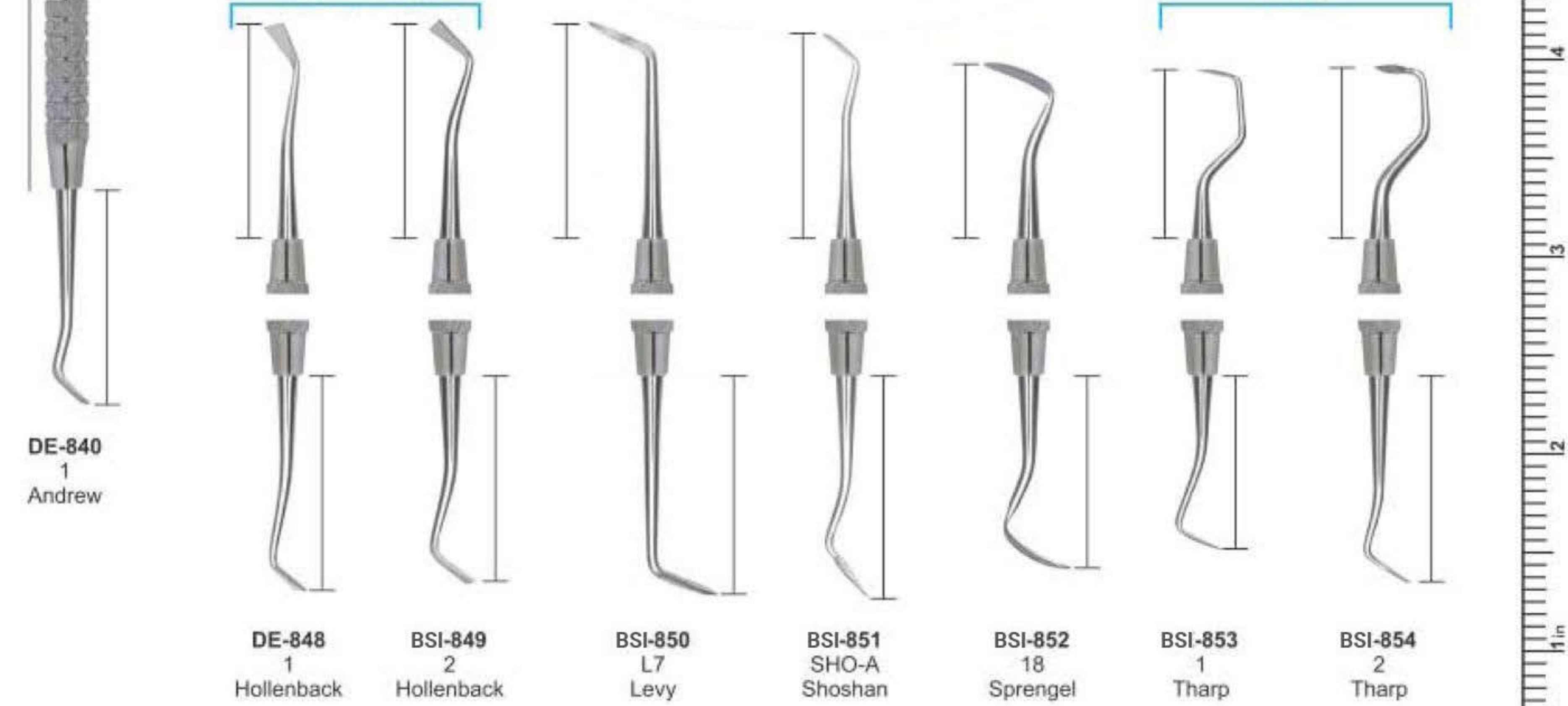



- Инструменты для реставрации
- Instruments pour amalgame
- Amalgampistolen

- Инструменти для реставрації
- instrumentos para amalgame
- تقطيع الملقم

**RESTORATIVE INSTRUMENTS SOLID HANDLE 6MM, LENGTH 170MM**

**CARVERS**

**AMALGAM FILES**

**HOES**

Forming Line Angles on Anterior Preparations.

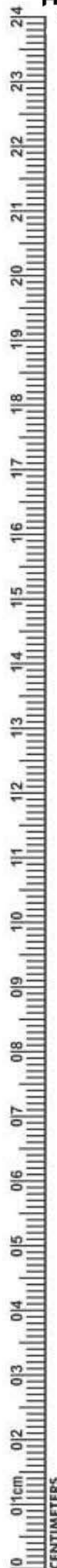

**NHS-855** Anatomical Carver  
Solid Handle Size 4108mm

**NHS-856** Discoid-Cleoid Carver  
Tip Size: 1/1

**NHS-857** 31/32 Rhein

**NHS-858** 1/4 Wedelstaedt

**NHS-859** 2/5 Wedelstaedt

**NHS-860** 1/2

**NHS-861** 4/5 #41, #6, #7

**NHS-862** 3/6 #41, #6, #7

**NHS-863** 20 (14-6-8)  
Solid Handle Size 122mm

**NHS-864** 21 (10-4-8)

**NHS-865** 22 (10-4-14)

**NHS-866** 23 (6.5-2.5-9)

**NHS-867** 89/92 #41, #6, #7

**NHS-868** 90B

**NHS-869** W-A-C-D

**DISCOID-CLEOIDS** (1.5, 2.0, 3.0)



# FILLING INSTRUMENTS

- Инструменты для реставрации
- Instruments pour plombage
- Füllungsinstrumente (mit Kontrawinkel)
- Інструменти для реставрації
- Instrumentos para obturaciones
- ملء الصكوك

**RESTORATIVE INSTRUMENTS**  
SOLID HANDLE 6MM, LENGTH 170MM

## MARGIN TRIMMERS



**NHS-870**  
26  
(13-95-8-14)  
Distal

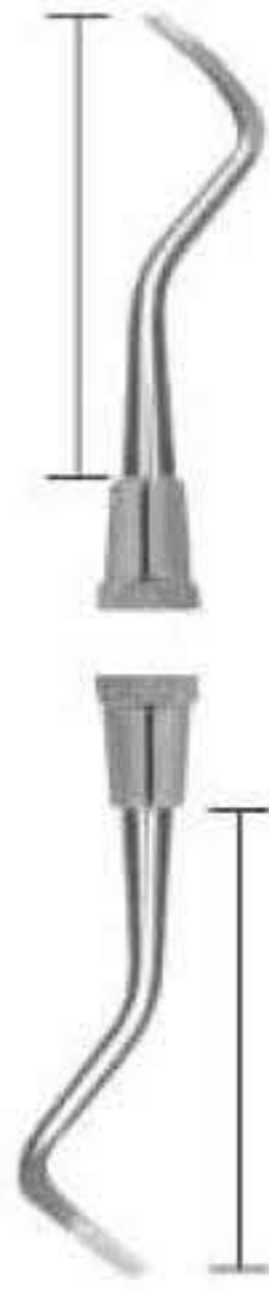

**NHS-871**  
27  
(13-80-8-14)  
Mesial



**NHS-872**  
28  
(10-95-7-14)  
Distal  
#41, #6



**NHS-873**  
29  
(10-80-7-14)  
Mesial  
#41, #6



**NHS-874**  
77/78  
(15-95-8-12)  
Distal



**NHS-875**  
79/80  
(15-80-8-12)  
Mesial

## ANGLE FORMERS



**NHS-876**  
30/31  
(12-80-5-8)



**NHS-877**  
32/33  
(9-80-4-8)



**NHS-878**  
34/35  
(7-80-2.5-9)

INCHES  
0 1 2 3 4 5 6 7 8 9





- Инструменты для реставрации
- Instruments a modeler
- Modellierinstrumente

- Инструменти для реставрації
- Instrumentos para modelar
- أدوات تقطيع

P.K. THOMS WAXING INSTRUMENTS SOLID HANDLE 6MM, LENGTH 170MM

P.K. THOMAS WAXING INSTRUMENTS

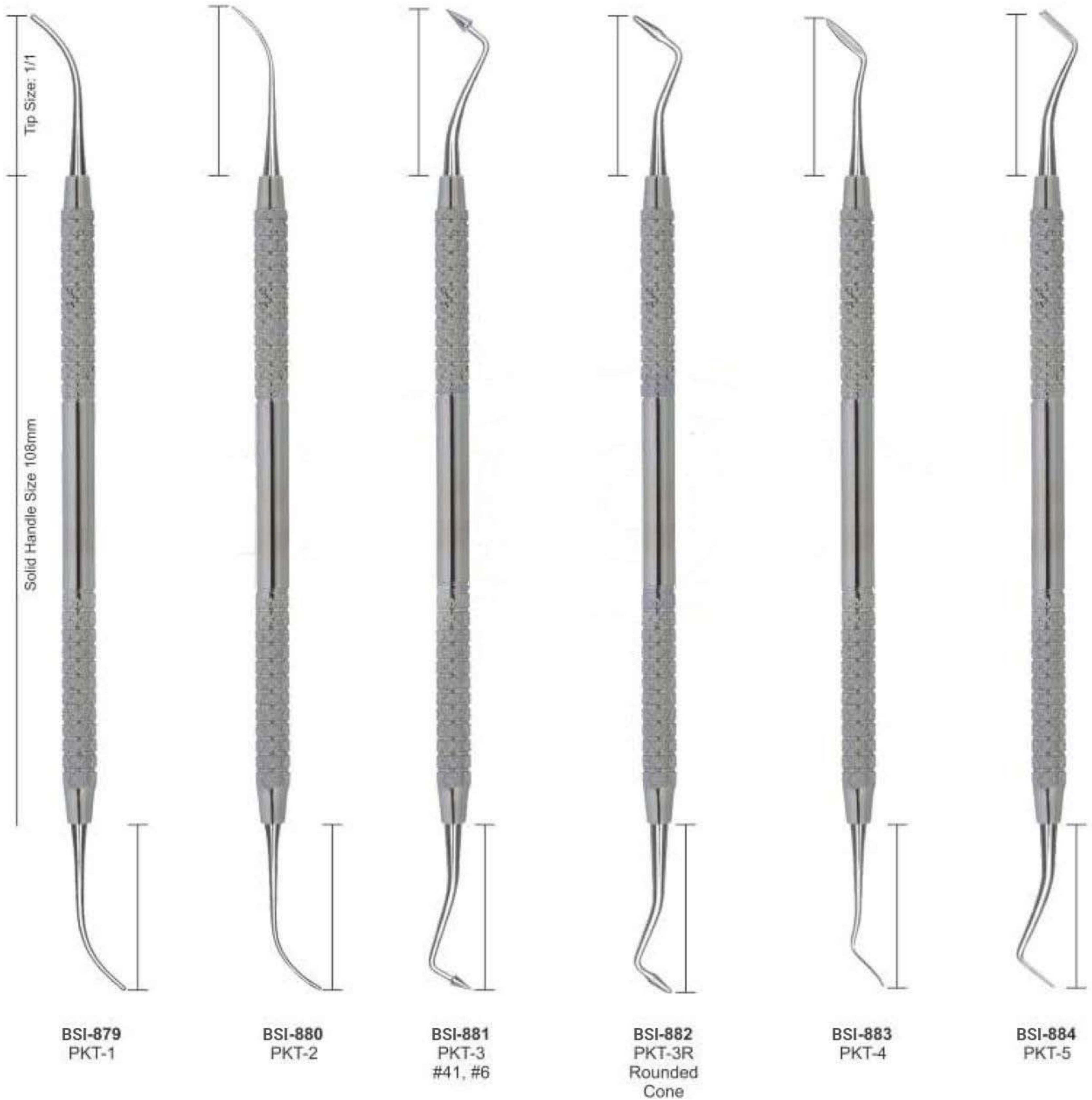
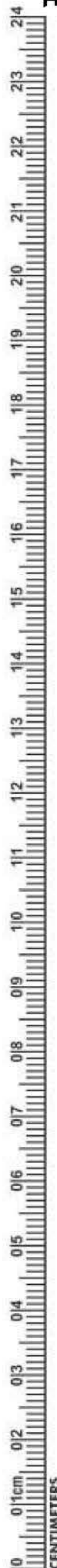



# FILLING INSTRUMENTS

- Инструменты для реставрации
- Instruments pour plombage
- Füllungsinstrumente (mit Kontrawinkel)
- Інструменти для реставрації
- Instrumentos para obturaciones
- ملء الصكوك

## CHISELS

## HOES







# CEMENT SPATULAS

- Шпатели для цемента
- Spatules à ciment
- Zementspatel

- Шпателі для цементу
- Espátulas para cemento
- ملاعق الاسمنت

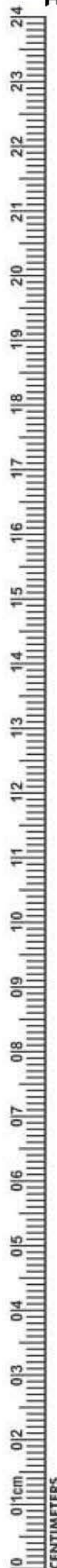

NHS-893 00    NHS-894 0    NHS-895 1    NHS-896 2    NHS-897 3    NHS-898 4    NHS-899 3 Weston    NHS-900 1 medium cement    NHS-901 1



NHS-902 Le Cron    NHS-903 Le Cron    NHS-904 Le Cron    NHS-905 MSY    NHS-906 MSY    NHS-907 Le Cron    NHS-908 Hylin    NHS-909 Hylin    NHS-910 Hylin    NHS-911 Zahle    NHS-912 Zahle    NHS-913 Zahle    NHS-914 Gritman



# WAX KNIVES

- Ножи для воска
- Couteaux a cire
- Wachsmesser
- Ножи для воску
- Cuchillos para cera
- السكاكين الشمع

ALGINATE, PLASTER SPATULAS, WAX KNIVES PLASTER FOR KNIVES & PLASTER SHEAR



<b>NHS-915</b> Wooden Handle Fig. 5 21.5 cm	<b>NHS-916</b> Wooden Handle Fig. 7 19.5 cm curved	<b>NHS-917</b> Wooden Handle Fig. 8 20 cm curved	<b>NHS-918</b> Wooden Handle Fig. 9 22.5 cm curved	<b>NHS-919</b> Hook Knives	<b>NHS-920</b> Fig. 1 Lessmann 12.5 cm	<b>NHS-921</b> Fig. 2 Lessmann 17 cm	<b>NHS-922</b> Fig. 1 with small spoon 12.5 cm	<b>NHS-923</b> Fig. 2 with large spoon 17 cm
<b>NHS-924</b> Bacolite Handle Wax Knives, Small	<b>NHS-925</b> Bacolite Handle Wax Knives, Large	<b>BSI-926</b> Wooden Handle Wax Knives, Small	<b>NHS-927</b> Wooden Handle Wax Knives, Large	<b>NHS-928</b> Plaster Knife	<b>NHS-929</b> Fig. 1 17 cm	<b>NHS-930</b> Fig. 3 16 cm	<b>NHS-931</b> Fig. 4 16 cm	<b>NHS-932</b> Special Inox 19.5 cm





- Артикуляторы
- Artocilar
- Artikulations

- Артикулятори
- Articular
- ارتیکولاتورس



**NHS-933**

**Technical Datas:**

Intercondylar distance	120 mm.
condylar inclination	fixed at 30°
Bennet angle	fixed at 7°
Incisal table inclination	10°
Distance between mounting plates	85 mm.
Weight	400 gr.
Opening (item 5000)	125°
Opening (item 5010)	180°



**NHS-934**

**Technical Datas:**

Intercondylar distance	110 mm.
condylar inclination	fixed at 30°
Bennet angle	fixed at 7°
Incisal table inclination	flat
Distance between mounting plates	85 mm.
Weight	450 gr.
Opening	180°



**NHS-935**

Stainless Steel Finishing

**NHS-936**

Royal Blue

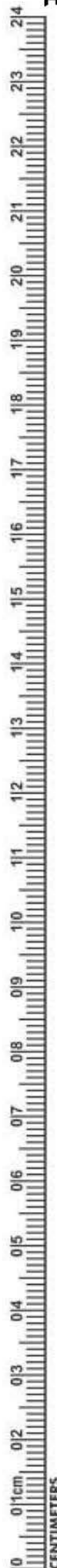

**NHS-937**



**NHS-938**



**NHS-939**



**NHS-940**



**NHS-941**



**NHS-942**



**NHS-943**



**NHS-944**



**NHS-945**



**NHS-946**  
**Nakawalni**  
Dental Laboratory  
Instrument



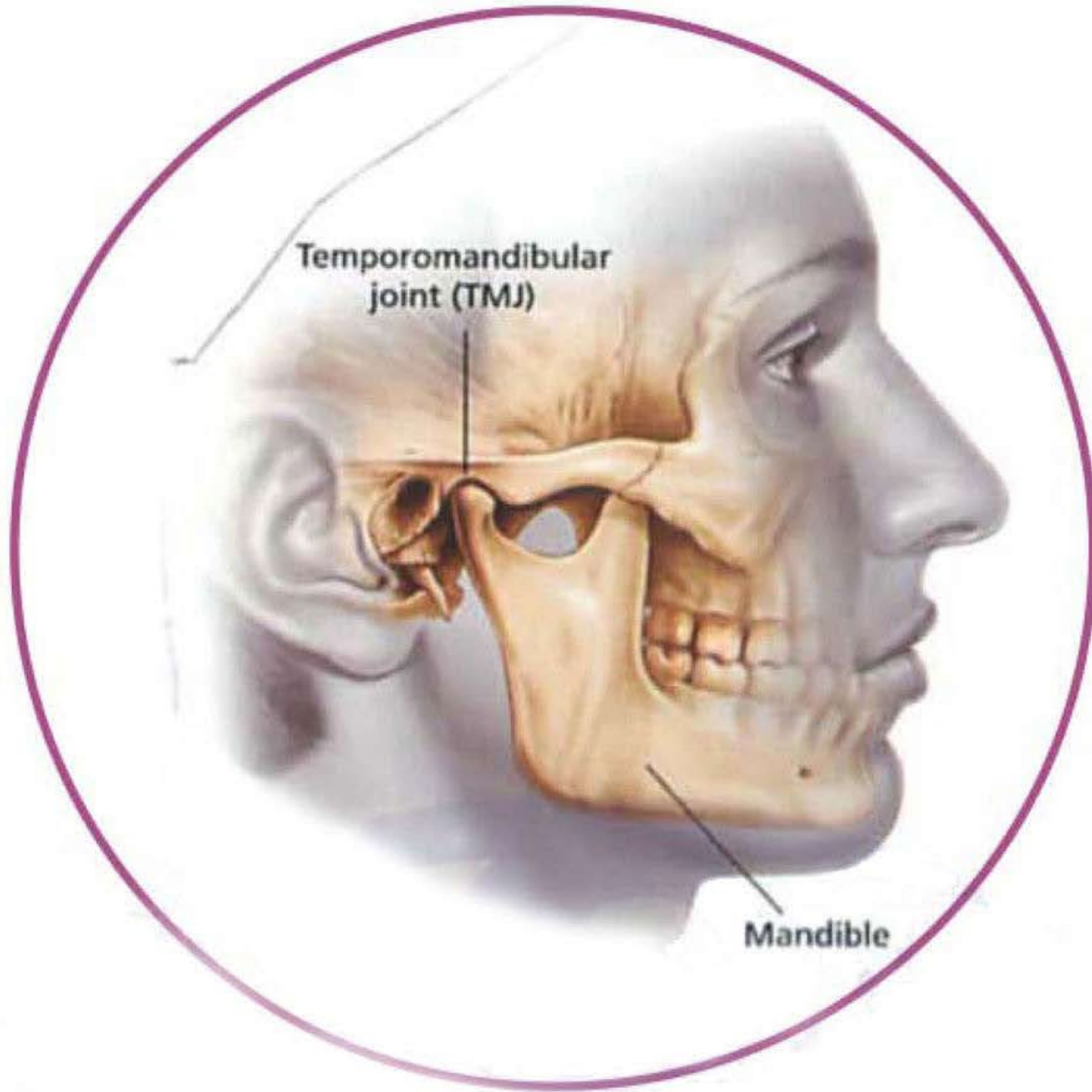



## RETRACTORS - MOUTH GAGS

- Роторасширители
- Роторозширювачі
- Ecarteurs - Ouvre-bouches
- Separadores - Abre-bocas
- Vestibulumabhalter / Mundspanner
- الكاشحات-الكمامات الفم



**NHS-947**  
Mouth Gag Molt  
11 cm for (Children)



**NHS-948**  
Mouth Gag Molt  
14 cm for (Adults)



**Cheek Retractor**  
NHS-949 140 mm  
NHS-950 180 mm



**Cheek Retractor**  
NHS-951 140 mm



**NHS-952**  
Wangen Holder,  
vestibule  
15 cm, with or without  
lip protection,



**NHS-953**  
Wangen Holder,  
vestibule 15 cm, with  
or without lip protection,



**NHS-954**  
Wangen Holder  
Wangen holder with dual  
function, 17 cm,



**NHS-955**  
140 mm

**NHS-956**  
150 mm

NHS

**Cheek Retractor**





## RETRACTORS - MOUTH GAGS

- Роторасширители
- Ecarteurs - Ouvre-bouches
- Vestibulumabhalter / Mundspanner
- Роторозширювачі
- Separadores - Abre-bocas
- الكاشطات - الكمامات الفم



**NHS-957**  
Fig. 1  
weitlaner  
10.5cm  
13.5cm



**NHS-958**  
Fig. 2  
weitlaner  
10.5cm  
13.5cm



**NHS-959**  
Stainless Steel  
Double  
Ended Cheek  
Retractors



**NHS-960**  
Stainless Steel  
Single  
Ended Cheek  
Retractors



**BSI-961** Weitlander 11cm  
**BSI-962** 13cm  
**BSI-963** 15cm



**NHS-967**  
Denhard  
12 cm



**NHS-968**  
Roser-König  
16 cm



**NHS-969**  
Roser-König  
19 cm



**NHS-964** Jennings 11cm  
**NHS-965** 13cm  
**NHS-966** 15cm

INCHES  
0  
1  
2  
3  
4  
5  
6  
7  
8  
9



**Wound, Bendable**  
Retractor, individually or as saving kit!

- Ранорасширители
- Ecarteurs
- Wundhaken

- Ранорозширювачі
- Separadores
- الكاشحات

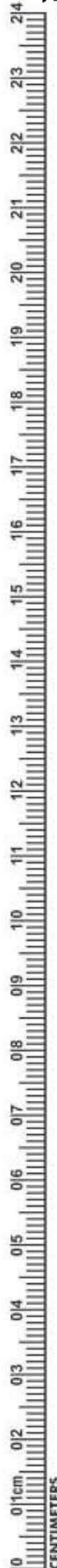

**NHS-970**  
Cheek Retractor  
Long



**NHS-971**  
Cheek Retractor  
Long



**NHS-972**  
Cheek Retractor  
Long



**Retractor with Ergo Grip**  
**NHS-973** 24 cm,  
ergonomic handle



**NHS-974**  
Cheek Retractors,  
Retractor Ivory  
Width adjustable  
& fixable, 20 cm,



**Cheek Retractors,**  
tongue depressors  
**NHS-975** 19 cm



**Cheek Retractors,**  
Minnesota  
**NHS-976** 16 cm



**Cheek Retractors,**  
**NHS-977** 20 cm  
easy to bend  
by hand,



**Cheek Retractors,**  
retractor and tongue  
pushers BISHOP with  
comfortable margin,  
**NHS-978** 16 cm,



**Retractors Cheek**  
retractor combination  
Combination,  
**NHS-979** 25 cm,



# RETRACTORS

- Ранорасширители
- Ecarteurs
- Wundhaken
- Ранорозширювачі
- Separadores
- الكاشحات



**NHS-982**  
Retractors, Unique  
Length 175 mm,  
angled 45°



**NHS-983**  
Retractors, Unique  
Length 175 mm,  
angled 90°



**NHS-984**  
Retractors  
16cm



**NHS-985**  
Retractors  
19cm



**NHS-986**  
Retractors, Mini-Langenbeck  
16 cm, hooks 22 mm,



**NHS-987**  
Retractors, CheekNHS  
retractors combination  
21 cm, 2



**NHS-988**  
Mini Retractor  
about 8 cm,



**NHS-989**  
Retractors  
17 cm, hooks 22 mm







- Ранорасширители
  - Ecarteurs
  - Wundhaken
- Ранорозширювачі
  - Separadores
  - الكاشحات



**NHS-990**  
**Retractors**, surgical-flat  
surgically-flat, 21 cm, hook  
30x16 mm,



**NHS-991**  
**Retractors**, surgical-flat  
surgically-flat, 21 cm, hook  
42x11 mm



**NHS-992**  
**Retractors**, surgical-flat  
surgically-flat, 21 cm, hook  
63x12 mm,



**Retractors**, surgical-flat  
surgically-flat, 21 cm, hook  
**NHS-993** 30x16 mm,  
**NHS-994** 42x11 mm  
**NHS-995** 63x12 mm,



**Retractors, Langenbeck**  
21 cm, hook  
**NHS-996** 30x11 mm  
**NHS-997** 30x16 mm,



**NHS-998**  
**Retractors**  
21 cm,

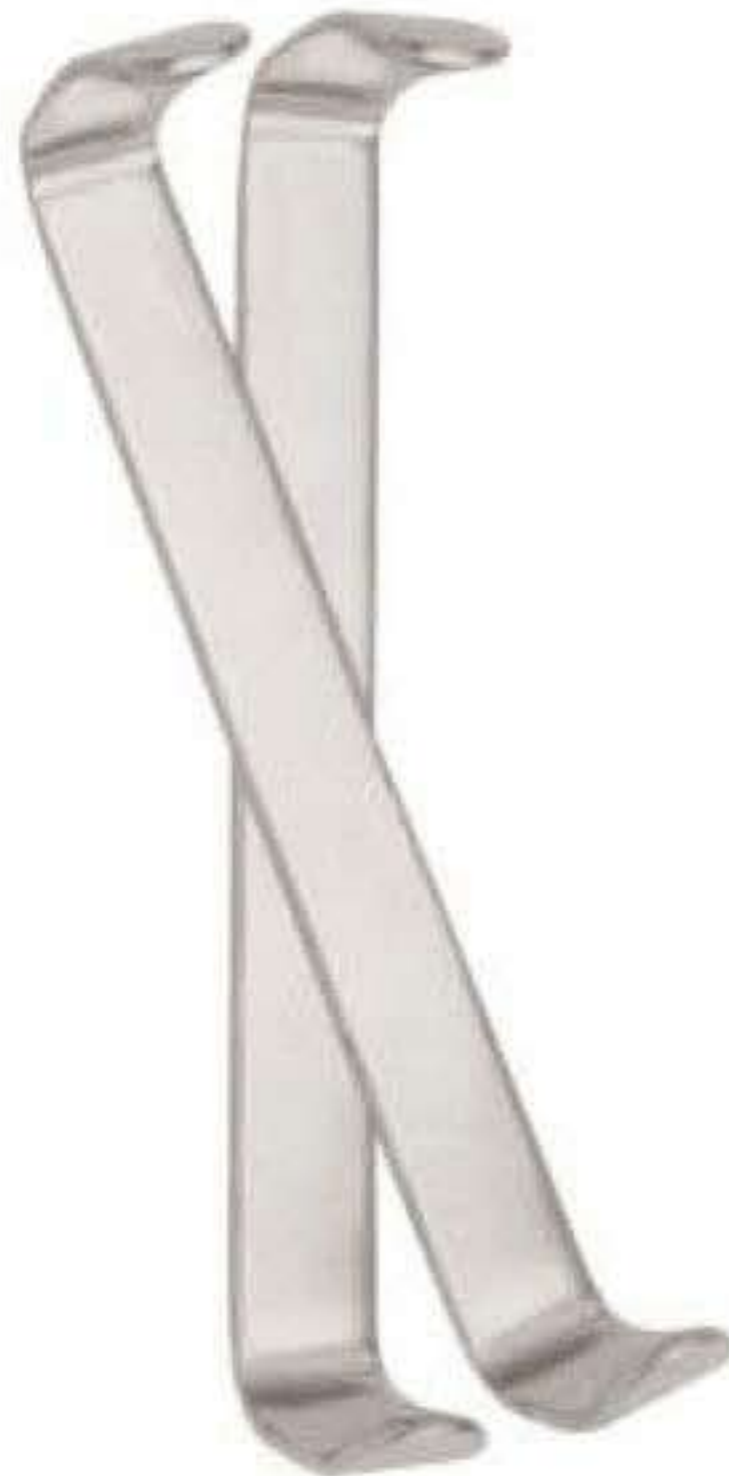

**NHS-999**  
**Farabeuf**  
(120 X 12mm  
Set of 2 pices)



**NHS-1000**  
**Retractor Seldin**



**NHS-1001**  
**FELDMAN**  
**RETRACTOR**  
5-1/2", 14cm

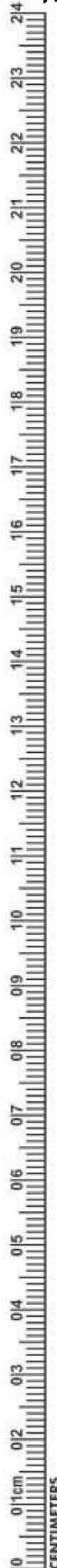



# GUM SCISSORS

- Ножницы десневые
- Ciseaux a gencives
- Zahnfleischscheren
- Ножиці для ясен
- Tijeras para encias
- مقص صمغ



**NHS-1002**  
Iris  
115mm  
Straight



**NHS-1003**  
Iris  
115mm  
Curved



**NHS-1004**  
Goldman-Fox  
130mm  
Saw edge, straight



**NHS-1005**  
Goldman-Fox  
130mm  
Saw edge, Curved



**NHS-1006**  
La Grange  
115mm  
Saw edge, double Curved



Mayo  
**NHS-1007** 140mm  
**NHS-1008** 170mm  
**NHS-1009** 230mm  
Straight



Mayo  
**NHS1010** 140mm  
**NHS1011** 170mm  
**NHS1012** 230mm  
Curved



Metzenbaum  
**NHS-1013** 145mm  
**NHS-1014** 180mm  
**NHS-1015** 200mm  
Straight



Metzenbaum  
**NHS-1016** 145mm  
**NHS-1017** 180mm  
**NHS-1018** 200mm  
Curved



**NHS-1019**  
Kelly  
160mm  
Straight



**NHS-1020**  
Kelly  
160mm  
Curved



**NHS-1021**  
Iris  
115mm  
Straight



**NHS-1022**  
Iris  
115mm  
Curved



**NHS-1023**  
La Grange  
115mm  
Double Curved



**NHS-1024**  
Goldman-Fox  
130mm, Straight



**NHS-1025**  
Goldman-Fox  
130mm, Curved



**NHS-1026**  
Kelly  
160mm, Curved



**NHS-1027**  
Iris  
115mm, Straight



**NHS-1028**  
Iris  
115mm, Curved



**NHS-1029**  
Micro Iris  
90mm, Curved





- Ножницы десневые
- Ножниці для ясен
- Ciseaux a gencives
- Tijeras para encias
- Zahnfleischscheren
- مقص صمغ

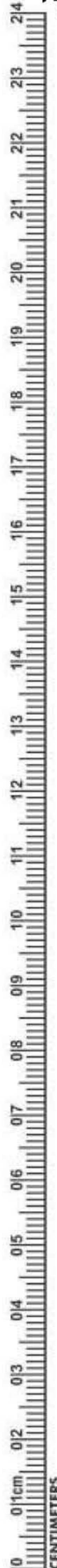

**NHS-1030**  
Iris  
115mm  
Angled



**NHS-1031**  
Iris  
115mm  
Curved



**NHS-1032**  
Goldman-Fox  
130mm  
Saw edge,  
straight



**NHS-1033**  
Goldman-Fox  
130mm  
Saw edge,  
curved



**NHS-1034**  
Goldman-Fox  
130mm  
Saw edge,  
double curved



**NHS-1035**  
La Grange  
115mm  
Saw edge,  
double curved



**NHS-1036**  
Neumann  
120mm  
Saw edge,  
double curved



**NHS-1037**  
Kilner (Ragnell)  
120mm  
Straight



**NHS-1038**  
Kilner (Ragnell)  
120mm  
Curved



**NHS-1039**  
Joseph  
140mm  
Straight



**NHS-1040**  
Joseph  
140mm  
Curved



**NHS-1041**  
Kelly  
160mm  
Straight



**NHS-1042**  
Kelly  
160mm  
Curved



**NHS-1043**  
Locklin  
160mm  
Saw edge,  
angular



**NHS-1044**  
Locklin  
120mm  
160mm  
Saw edge,  
angular



**NHS-1045**  
Dean  
170mm  
Saw edge,  
angular



**NHS-1046**  
Spencer  
90mm



**NHS-1047**  
Spencer  
130mm



**NHS-1048**  
Spencer  
115mm



**NHS-1049**  
Noyes  
110mm, Straight



**NHS-1050**  
Noyes  
110mm  
Curved



**NHS-1051**  
Noyes  
110mm  
Angular



**NHS-1052**  
Castroviejo  
150mm  
Curved



# NEEDLE HOLDERS

- Иглодержатели
- Porte-aiguilles
- Nadelhalter

- Голкотримачи
- Porta-agujas
- اصحاب ابرة



**NHS-1053**  
130mm  
Straight

**NHS-1054**  
**NHS-1055**  
**NHS-1056**



Mayo 130mm  
Mayo 160mm  
Mayo 180mm  
Straight Curved

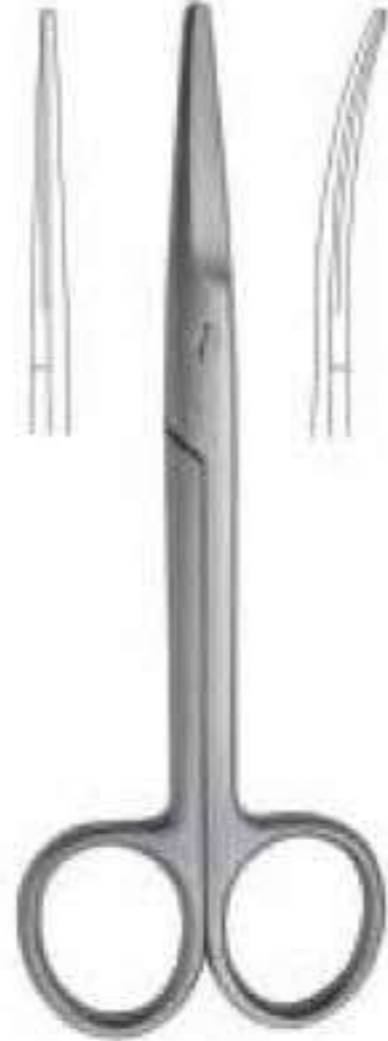

**NHS-1057** 140mm  
**NHS-1058** 200mm  
Mayo 140mm  
Mayo 200mm  
Straight Curved



**NHS-1059** 145mm  
**NHS-1060** 200mm  
Metzenbaum 145mm  
200mm  
Straight Curved



**NHS-1061**  
Beebee 110mm  
Saw edge, straight



**NHS-1062**  
Beebee 110mm  
Saw edge, curved



**NHS-1063**  
Beebee 110mm  
Saw edge, straight



**NHS-1064**  
Beebee 110mm  
Saw edge, curved

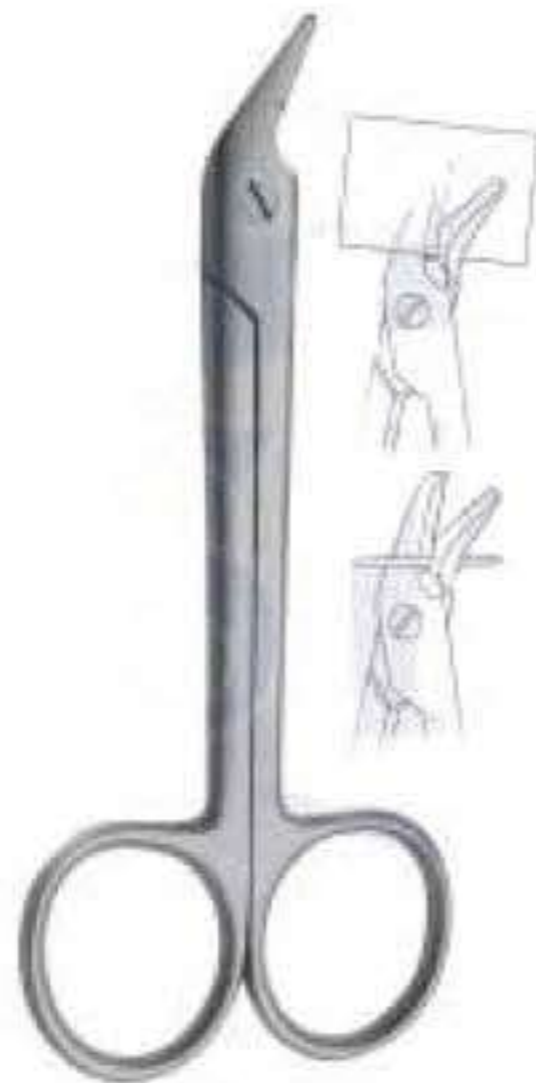

**NHS-1065**  
Universal 120mm  
Saw edge



**NHS-1066**  
Universal 120mm



Crile  
**NHS-1067** 130mm  
**NHS-1068** 150mm  
**NHS-1069** 180mm



**NHS-1070**  
Halsey 130mm



**NHS-1071**  
Baumgartner 130mm



**NHS-1072**  
Derf 120mm



**NHS-1073**  
Delicate 150mm



Mayo-Hegar  
**NHS-1074** 130mm  
**NHS-1075** 160mm  
**NHS-1076** 180mm  
**NHS-1077** 200mm



**NHS-1078**  
Crile-Wood 150mm  
straight



**NHS-1079**  
Crile-Wood 150mm  
curved



- Иглодержатели
- Porte-aiguilles
- Nadelhalter

- Голкотримачи
- Porta-agujas
- أصحاب ابرة

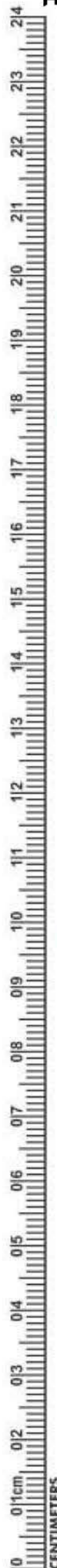

Castroviejo  
NHS-1080 130mm  
NHS-1081 150mm  
NHS-1082 180mm



NHS-1083  
Halsey  
130mm



NHS-1084  
Baumgartner  
130mm



NHS-1085  
Derf  
120mm



NHS-1086  
Delicate  
150mm



BSI-1087  
Adson  
170mm



Mayo-Hegar  
BSI-1088 130mm  
BSI-1089 160mm  
BSI-1090 180mm  
BSI-1091 200mm



BSI-1092  
Crile-Wood  
150mm



Castroviejo  
NHS-1093 str 140mm cvd  
NHS-1094 str 180mm cvd



Olsen-Hegar Needle  
Holder With Scissors  
NHS-1095 140mm



Gillies Needle  
Holder With Scissors  
NHS-1096 160mm



Mathieu  
NHS-1097 140mm  
NHS-1098 170mm



Castroviejo  
NHS1099 str 140mm cvd  
NHS1100 str 180mm cvd



Olsen-Hegar Needle  
Holder With Scissors  
NHS-1101 140mm



Gillies Needle  
Holder With Scissors  
NHS-1102 160mm

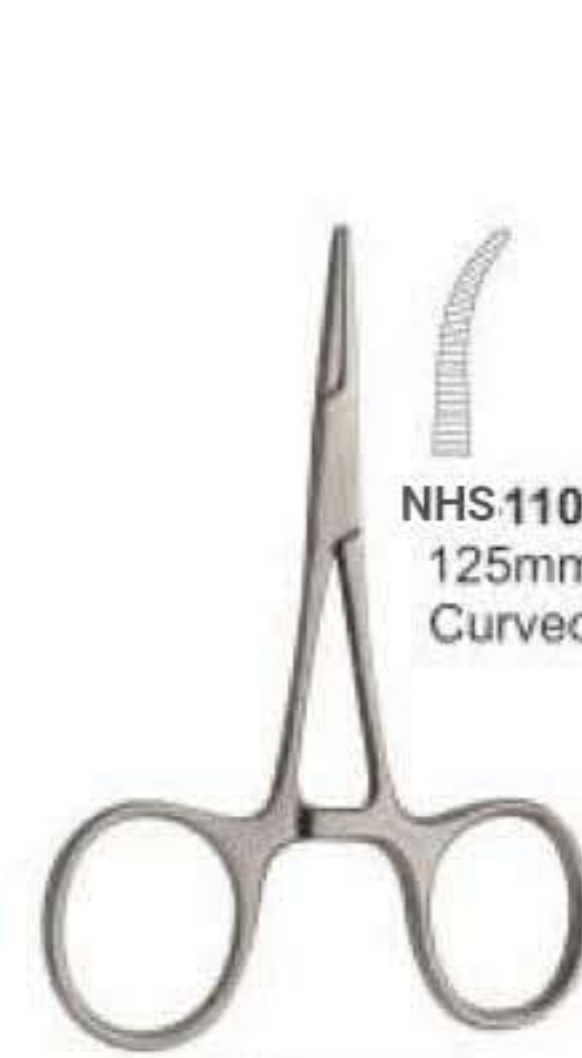

Hartmann (Baby  
Mosquito)  
NHS1103 90mm straight



Halstead Mosquito  
NHS-1105 125mm  
Straight













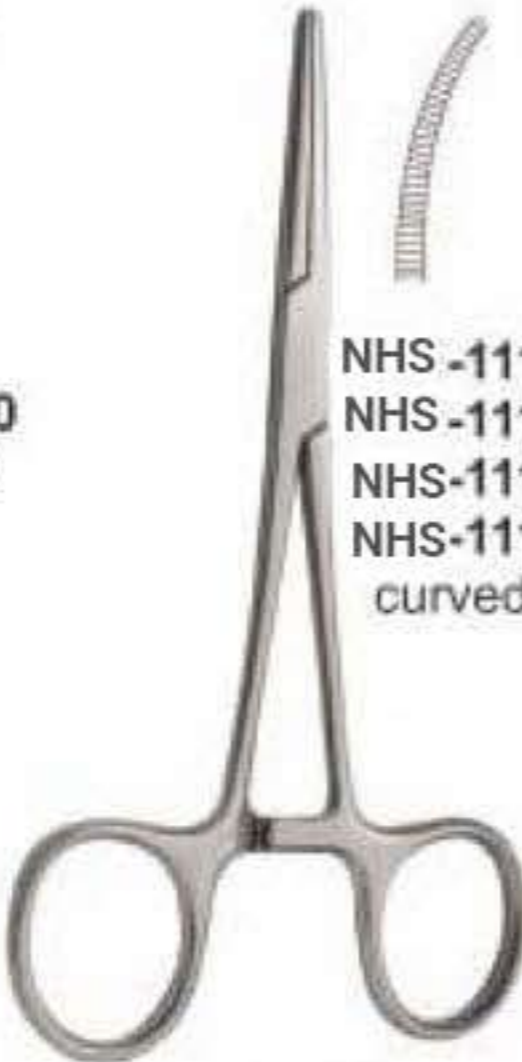

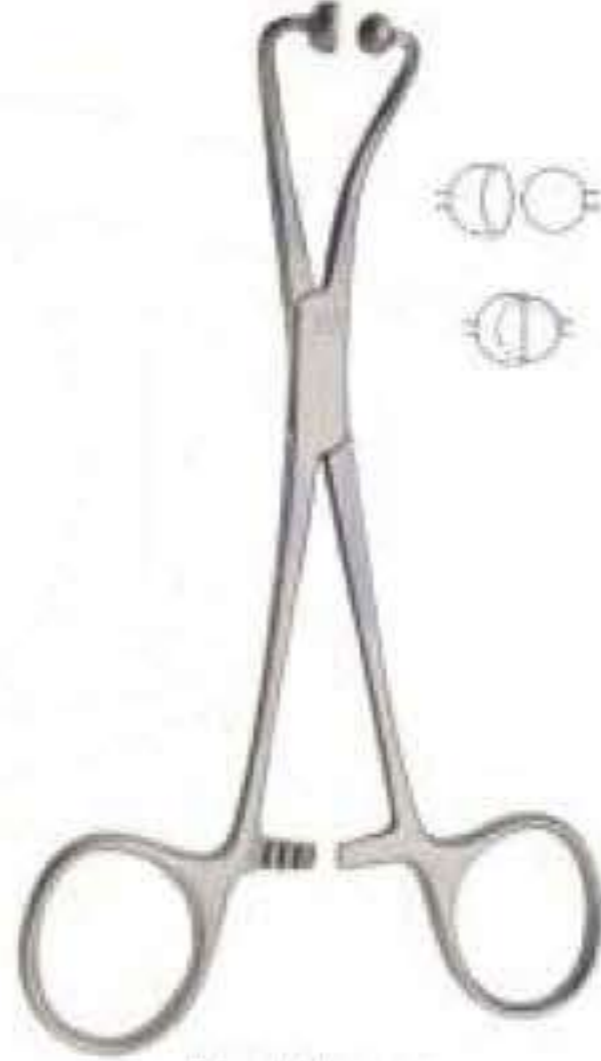

NHS1104  
125mm  
Curved

NHS-1106  
Curved



# HAEMOSTATIC FORCEPS & TOWEL CLAMPS

- Зажимы артериальные, зажимы для салфеток
- Pinces hemostatiques, Pinces a compresses
- Arterienklemmen, Tuyschklemmen
- Затискачі артеріальні, затискачі для серветок
- Pinzas hemostaticas, Pinces para compresas
- الملقط هيموستاتيک المشابك منشفة

 <p><b>NHS1108</b> curved</p> <p>Halstead Mosquito 1x2 <b>NHS-1107</b> 125mm straight</p>	 <p><b>NHS-1110</b> curved</p> <p>Kelly <b>NHS-1109</b> 140mm straight</p>	 <p><b>NHS-1115</b> 140mm <b>NHS-1116</b> 160mm <b>NHS-1117</b> 180mm <b>NHS-1118</b> 200mm curved</p> <p>Rochester-Pean <b>NHS-1111</b> 140mm <b>NHS-1112</b> 160mm <b>NHS-1113</b> 180mm <b>NHS-1114</b> 200mm straight</p>	 <p><b>NHS-1123</b> 140mm <b>NHS-1124</b> 160mm <b>NHS-1125</b> 180mm <b>NHS-1126</b> 200mm curved</p> <p>Rochester-Kocher 1x2 <b>NHS-1119</b> 140mm <b>NHS-1120</b> 160mm <b>NHS-1121</b> 180mm <b>NHS-1122</b> 200mm straight</p>	 <p><b>NHS-1128</b> curved</p> <p><b>NHS-1127</b> Kelly-Rankin 160mm straight</p>	
 <p>Lorna <b>NHS-1129</b> 100mm <b>NHS-1130</b> 130mm</p>	 <p><b>NHS-1131</b> Allis-Baby 3:4 150mm</p>	 <p><b>NHS-1132</b> Allis 4:5 200mm</p>	 <p><b>NHS-1133</b> Allis 6:7 200mm</p>	 <p>Backhaus <b>NHS-1134</b> 140mm Not-perforating and not-damaging</p>	 <p><b>BSI-1135</b> Backhaus 130mm</p>
 <p><b>BSI-1136</b> Backhaus 85mm</p>	 <p><b>NHS-1137</b> Jones 90mm</p>	 <p><b>NHS-1139</b> curved</p> <p>Gross Maier Dressing Forceps <b>NHS-1138</b> 200mm straight</p>	 <p><b>NHS-1140</b> 200mm</p> <p>Foerster Dressing Forceps</p>	 <p>Spare rubber</p> <p>Young Tongue Forceps <b>NHS-1141</b> 170mm</p>	 <p><b>NHS-1142</b> 170mm</p> <p>Collins Tongue Forceps</p>





- Инструменты для системы коффердам
- Pincas porte-crampons a dique
- Kofferdam Klammerzangen

- Инструменты для системы коффердам
- Pinzas de engrapar para dique de caucho
- السد المطاط الملقط المشابك



### BSI-1143

On request the Content of the rubber dam kit can be changed with other instruments.

#### Content:

- |    |                           |    |                           |
|----|---------------------------|----|---------------------------|
| 01 | Anisworth                 | 08 | Rubber Dam Clamp Fig. 212 |
| 02 | Brewer                    | 09 | Rubber Dam Clamp Fig. 211 |
| 03 | Clamps Stand              | 10 | Rubber Dam Clamp Fig. 8   |
| 04 | Denture Plate             | 11 | Rubber Dam Clamp Fig. 8A  |
| 05 | Rubber Dam Frame          | 12 | Rubber Dam Clamp Fig. 14  |
| 06 | Rubber Dam Box Lower Case | 13 | Rubber Dam Clamp Fig. 14A |
| 07 | Rubber Dam Box Upper Case | 14 | Rubber Dam Clamp Fig. 0   |
|    |                           | 15 | Rubber Dam Clamp Fig. 00  |
|    |                           | 16 | Rubber Dam Clamp Fig. 2   |
|    |                           | 17 | Rubber Dam Clamp Fig. 2A  |
|    |                           | 18 | Rubber Dam Clamp Fig. 7   |



NHS-1144  
Anisworth



NHS-1145  
Brewer



NHS-1146  
Ivory light weight



NHS-1147  
Palmer



NHS-1148  
Separating  
Elastic  
Plier



# RUBBER DAM CLAMPS

- Кламмера для коффердама
- Crampons pour digue
- Kofferdam Klammern
- Кламмера для коффердама
- Grapas para dique de caucho
- المشابك السد المطاط



NHS-1149  
Fig. 15



NHS-1150  
Fig. 18



NHS-1151  
Fig. 24



NHS-1152  
Fig. 25



NHS-1153  
Fig. 26



NHS-1154  
Fig. 28



NHS-1155  
Fig. 30



NHS-1156  
Fig. 31



NHS-1157  
Fig. 51



NHS-1158  
Fig. 138



NHS-1159  
Fig. 139



NHS-1160  
Fig. 200



NHS-1161  
Fig. 201



NHS-1162  
Fig. 202



NHS-1163  
Fig. 203



NHS-1164  
Fig. 204



NHS-1165  
Fig. 205



NHS-1166  
Fig. 3



NHS-1167  
Fig. W3



NHS-1168  
Fig. 4



NHS-1169  
Fig. 56A



NHS-1170  
Fig. 7



NHS-1171  
Fig. 7A



NHS-1172  
Fig. 8



NHS-1173  
Fig. 8A



NHS-1174  
Fig. W8A



NHS-1175  
Fig. 10



NHS-1176  
Fig. 11



NHS-1177  
Fig. 12A



NHS-1178  
Fig. 13A



NHS-1179  
Fig. 14



NHS-1180  
Fig. 14A



NHS-1181  
Fig. 14AN



NHS-1182  
Fig. 22



NHS-1183  
Fig. 27



NHS-1184  
Fig. 207



NHS-1185  
Fig. 29



NHS-1186  
Fig. 206



NHS-1187  
Fig. 208



NHS-1188  
Fig. 209



NHS-1189  
Fig. 1



NHS-1190  
Fig. 1A



NHS-1191  
Fig. 2



NHS-1192  
Fig. 2A



NHS-1193  
Fig. W2A



NHS-1194  
Fig. 0



NHS-1195  
Fig. 00



NHS-1196  
Fig. 210



NHS-1197  
Fig. 211



NHS-1198  
Fig. 212



NHS-1199  
Fig. 6



NHS-1200  
Fig. 9



NHS-1201  
Fig. N06



NHS-1202  
Fig. U67



NHS-1203  
Fig. 214



NHS-1204  
Fig. P1



NHS-1205  
Fig. P2



NHS-1206  
Fig. G-1



NHS-1207  
Fig. G-2





## CROWN REMOVER

- Инструменты для удаления коронок
- Arrache-couronnes
- Teleskopkronenzangen

- Инструменты для удаления коронок
- Arranca-corona
- مزيلات التاج



**NHS-1210**  
Crown Spreaders



**NHS-1211**  
Mershon  
14 cm  
Band Pusher



**NHS-1212**  
Fig. 0



**NHS-1213**  
Manual Crown Remover



**NHS-1214**  
Complete with 3 tips  
and tightening keys

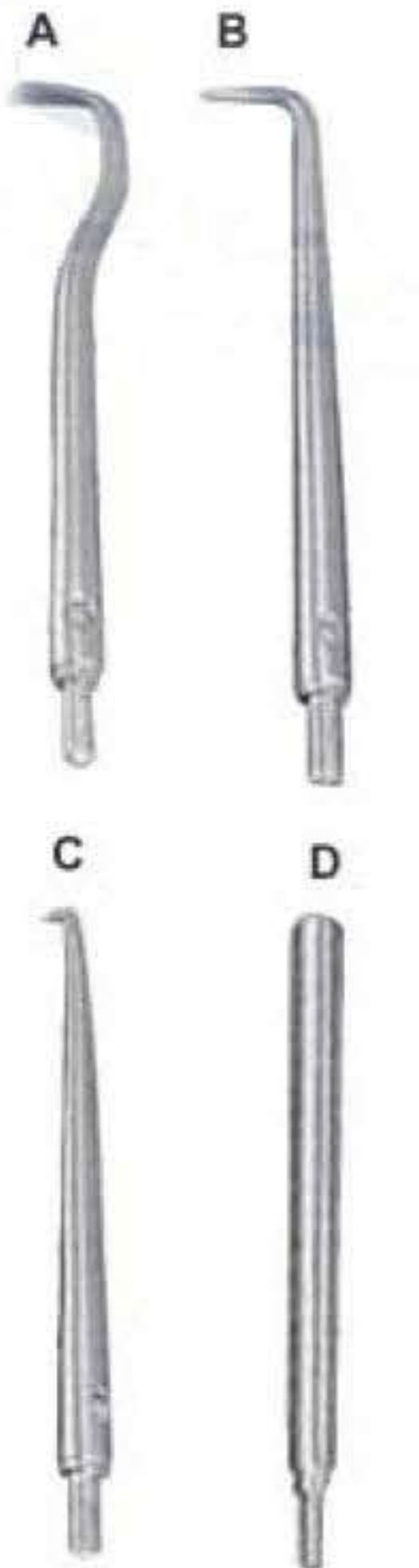

**A B C D**  
semi-automatic crown  
& bridge remover



**NHS-1215**



**NHS-1216**  
Manual Crown Remover





# MATRIX RETAINERS

- Матрицедержатели
- Porte Matrices
- Matrizenspanner

- Матрицеутримувачи
- Porta Matrices
- مصفوفة الخدم



**NHS-1217**  
Fig. 5  
Ivory 8  
5 cm



**NHS-1218**  
Fig. 6  
Ivory 8  
6 cm



**NHS-1219**  
Fig. 7  
Ivory 8  
7 cm



**NHS-1220**  
Fig. 1  
Tofflemire-Universal



**NHS-1221**  
Fig. 2  
Tofflemire-Junior



**NHS-1222**  
Fig. 3  
Tofflemire-Senior



**NHS-1223**  
Narrow



**NHS-1224**  
Wide

## Siqueland Retainers

## Amalgam Well



**NHS-1225**  
Stainless Steel  
Amalgam Well



**NHS-1226**  
Ivory 12



**NHS-1227**  
Ivory 1



**NHS-1228**  
Ivory



**NHS-1229**  
Elliot

INCHES  
0 1 2 3 4 5 6 7 8 9





# AMALGAM INSTRUMENTS & SCALPEL HANDLES

Инструменты для амальгамы  
 • Instruments pour amalgame  
 • Amalgamisinstrumente

• Инструменти для амальгами  
 • Instrumentos para amalgama  
 • الصكوك الملقم

• Ручки для скальпелей  
 • Manches de bistouris  
 • Skalpellgriffe

• Ручки для скальпелів  
 • Mangos de bisturi  
 • مشرط مقابض

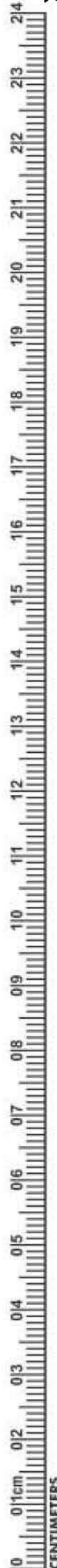

Ø 2mm

NHS-1230 Fig. 10 165mm English pattern



Ø 2mm

NHS-1231 Fig. 1 185mm German pattern



Ø 2mm

NHS-1232 Fig. 1 150mm Swiss pattern



Ø 2mm

NHS-1233 Fig. 1 150mm



Ø 2mm

NHS-1234 Fig. 2 150mm, 45°



Ø 2mm

NHS-1235 Fig. 3 140mm, 90°



NHS-1236 Fig.3 5" (12.7cm)



NHS-1237 Fig.3G 5" (12.7cm)



NHS-1238 Fig.4 5 1/2" (13.7cm)



NHS-1239 6 Way Adjustable Scalpel Handle



Locks At 90°, 60°, 30°, Straight, 120°, 150°, 180°, Angles



# AMALGAM INSTRUMENTS

- Инструменты для амальгамы
- Instruments pour amalgame
- Amalgamisinstrumente
- Инструменти для амальгами
- Instrumentos para amalgama
- الصكوك الملقم

## AMALGAM CARRIERS



**NHS-1240**  
Distal  
Improves visibility  
and access to  
posterior regions.

**NHS-1241**  
Single-End

**NHS-1242**  
Double-End

### TIP SIZES FOR DOUBLE-END



1.5 mm

2.8 mm

3.2 mm



2.0 mm  
**NHS-1243**  
Mini/  
Regular



2.0 mm  
**NHS-1244**  
Large/  
Regular



2.0 mm  
**NHS-1245**  
Jumbo/  
Regular

### TIP SIZES FOR DISTAL OR SINGLE-END



1.5 mm

2.0 mm

2.8 mm



**NHS-1246**  
Mini/  
Single-End



**NHS-1247**  
Regular  
Single-End



**NHS-1248**  
Large  
Single-End



1.5 mm  
**NHS-1249**  
Mini  
Distal



2.0 mm  
**NHS-1250**  
Regular  
Distal



**NHS-1251**  
Amalgam  
Well





**ROOT PLANNING FILES**



**NHS-1252**  
Kramer-Nevis  
Bone Chisel



**NHS-1253**  
Kramer-Nevis  
Bone Chisel



**NHS-1254**  
Molt 18.5cm  
Auto Clavable  
Plastic Tips.



**NHS-1255**  
Mead 18.5cm  
Non Auto Clavable  
Plastic Tips.



**NHS-1256**  
Miller



**NHS-1257**  
Miller

**BONE FILES**



**NHS-1258**  
Miller 21



**NHS-1259**  
Miller 1X  
cross cut



**NHS-1260**  
Miller 2X  
cross cut



**NHS-1261**  
Miller 52



**NHS-1262**  
Wahl 1





# PERIODONTAL INSTRUMENTS

- Инструменты пародонтологические
- Instruments pour la parodontologie
- Instrumente für die Parodontologie
- Инструменти пародонтологічні
- Instrumentos para periodoncia
- الصكوك اللثة

## PERIOSTEEL ELEVATORS



NHS-1263 BUSER    NHS-1264 Ohl 10    NHS-1265 Howard 9H    NHS-1266 Freer    NHS-1267 Freer 15    NHS-1268 Freer 16    NHS-1269 Molt 9    NHS-1270 Allen 9A    NHS-1271 Prichard 3



NHS-1272 Seldin 23    NHS-1273 Goldman-Fox 14    NHS-1274 P 24G    NHS-1275 Raspator, Length 175 mm,    NHS-127A Raspator, Length 175 mm,    NHS-127B Raspator, Length 175 mm,    NHS-1276 Raspator, Williger Length 170 mm, different widths (4 mm, 5 mm or 7 mm),    NHS-1276A Raspator, Williger Length 170 mm, different widths (4 mm, 5 mm or 7 mm),    NHS-1276B Raspator, Williger Length 170 mm, different widths (4 mm, 5 mm or 7 mm).







NAZEERIYA HAROONIYA Surgical Industries

# ORTHODONTIC INSTRUMENTS



## Behind Every Smile is a Story

- QUALITY - ЯКІСТЬ
- PRECISION - ТОЧНІСТЬ
- ACCURACY - ПРАВИЛЬНІСТЬ
- DURABILITY - ЗНОСОСТІЙКІСТЬ

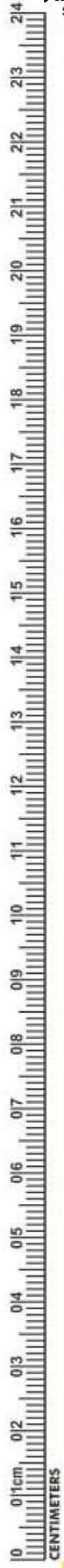
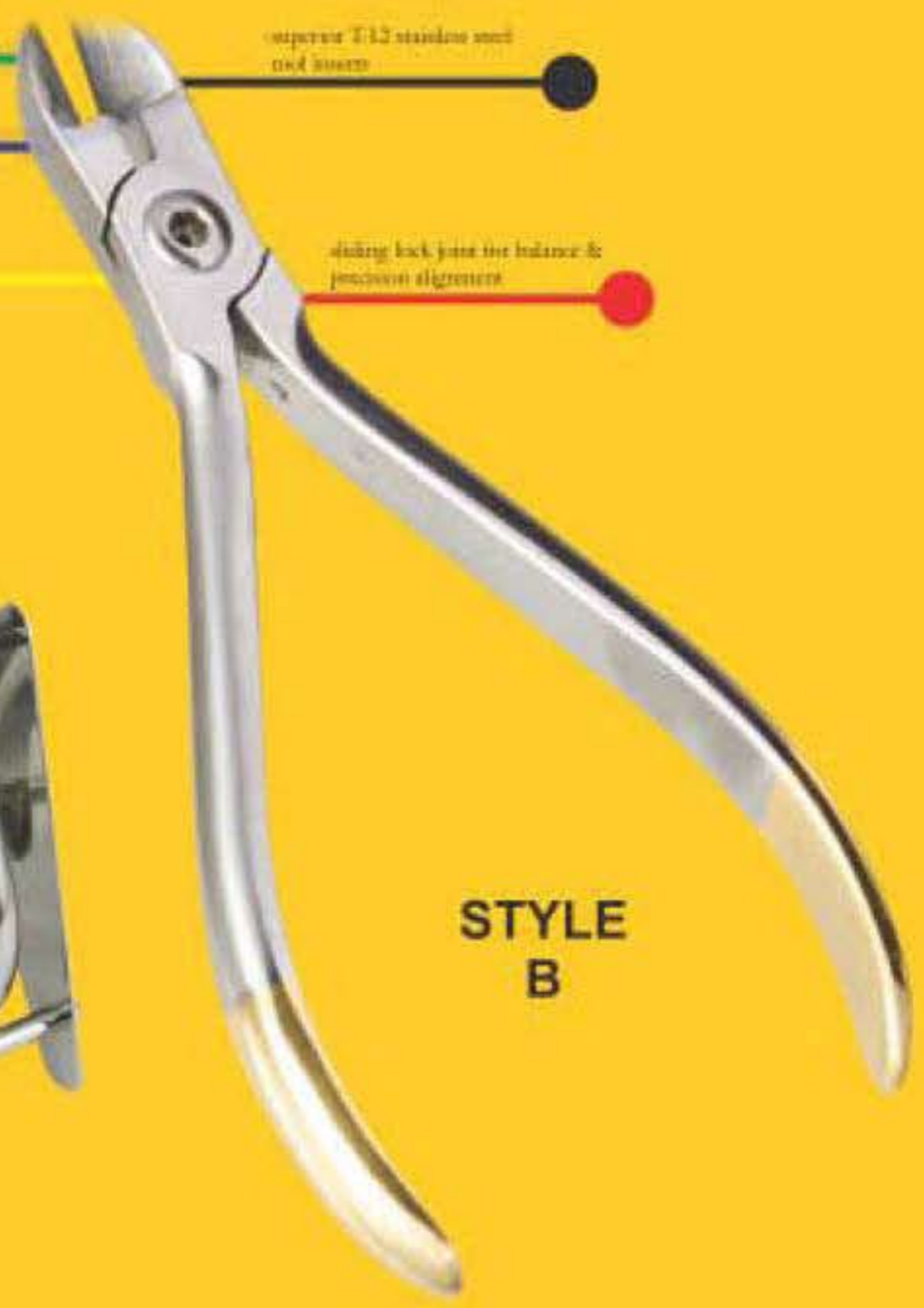



# ORTHODONTIC INSTRUMENTS

- Инструменты ортодонтические
- Instrumentos Ortodonticos
- Orthodontische Instrumente
- Інструменти ортодонтичні
- Instruments Orthodontiques
- أدوات تقويم الأسنان



**NHS-1277**  
Aluminum Height  
Gauge 0.22



**NHS-1278**  
Aluminum Height  
Gauge 0.18



**NHS-1279**  
Bone Bracket Gauge



**NHS-1280**  
Bone Thickness Gauge  
40mm, 180mm



**NHS-1281 OSTEOMETER**  
Measuring Forceps For Jaw  
Ridge Width measurement, scale  
on both sides, rustfree, autoclavable



**NHS-1282**  
Direct bonding  
bracket holders,  
135mm



**NHS-1283**  
Deluxe Bracket  
Holder Tweezers



**NHS-1284**  
Direct bonding  
bracket holders,  
136mm



**NHS-1285**  
Direct Bond  
Bracket Holder  
Tweezers,  
Small Tip



**NHS-1286**  
Direct bonding  
bracket holders,  
140mm



**NHS-1287**  
Direct bonding  
bracket holders,  
135mm



**NHS-1288**  
Direct Bonding  
Bracket Holders,  
140mm





- Инструменты ортодонтические
- Instrumentos Ortodonticos
- Orthodontische Instrumente
- Инструменти ортодонтични
- Instruments Orthodontiques
- ادوات تكويم الاسنان



**NHS-1289**  
Band seater auto cleavable



**NHS-1290**  
Ortho light scaler double ended



**NHS-1291**  
Ortho light scaler double ended



**NHS-1292**  
Ortho light scaler double ended



**NHS-1293**  
Twiel-on elastic module instrument



**NHS-1294**  
Twiel-on elastic module instrument



**NHS-1295**  
Schure Band Seater



**NHS-1296**  
Ortho light scaler



**NHS-1297**  
Ortho light scaler



**NHS-1298**  
Ortho light scaler heavy



**NHS-1299**  
Ortho instrument

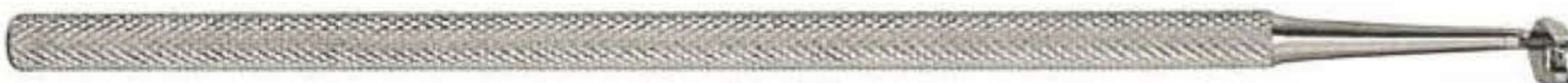

**NHS-1300**  
Ortho instrument



**NHS-1301**  
Ortho Light Band Pusher Scaler

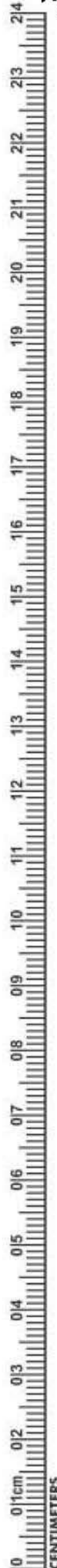



# ORTHODONTIC INSTRUMENTS

- Инструменты ортодонтические
- Instrumentos Ortodonticos
- Orthodontische Instrumente
- Инструменти ортодонтични
- Instruments Orthodontiques
- أدوات تقويم الأسنان



**NHS-1302**  
Ortho Light double ended  
ligature director



**NHS-1303**  
Ortho Light double ended  
ligature director scaler



**NHS-1304**  
Ortho Light double ended ligature scaler director  
tivate coil spring are remove modules with one instruments



**NHS-1305**  
Ortho band pusher scaler



**NHS-1306**  
Ortho Light Band Pusher Scaler



**NHS-1307**  
Ortho ligature director single ended



**NHS-1308**  
Ortho Light double ended ligature  
director scaler



**NHS-1309**  
Ortho Light double ended ligature scaler/director  
tivate coil spring are remove modules with one instruments



**NHS-1310**  
Ortho Light double ended ligature director



**NHS-1311**  
Ortholite Ligature Director Scaler



**NHS-1312**  
Ortho light ligature director double ended



**NHS-1313**  
Double ended cement spatula



**NHS-1314**  
Ortho light scaler single ended



INCHES



## PLIERS FOR ORTHODONTICS & PROSTHETICS

- Щипцы для ортодонтии и протезирования
- Pincers pour l'orthodontie et la prothèse
- Zangen für Kieferorthopädie und Prothetik
- Щипці для ортодонції та протезування
- Alicates para ortodoncia y prótesis
- كمشة لتقويم الأسنان بروتیسیس

### BOX JOINT PLIERS

**NHS-1315**  
Universal Dolphin Style  
Wire Bending & cutting pliers



**NHS-1316 Band Removing Plier**  
The curved blade of the band removing plier can strip easily and gently remove directly to the tooth. Length 130mm



**NHS-1317**  
Tweed Loop  
forming Pliers



**NHS-1318**  
How Plier curved  
Universally usable tool for  
the multiband technology for  
wires up to .028".  
Length 130mm



**NHS-1319 How Plier**  
Universally usable tool for the  
multiband technology for wires  
up to .028".  
Length 135mm



**NHS-1320**  
Nance Loop  
forming Pliers



**NHS-1321**  
Bracket Removing Plier curved  
Bracket Removing Plier curved for  
easy removal of brackets in the  
posterior region. Length 130mm



**NHS-1322**  
Young Wire Bending &  
Loop Forming Pliers



**NHS-1323**  
Wire Bending &  
Loop Forming Pliers



**NHS-1324**  
Adams, small wire bending  
and loop forming Pliers



**NHS-1325**  
Bracket Removing Plier Round Box  
Bracket removing plier for comfortable  
and quick removal of the brackets.  
Length 135mm



**NHS-1326**  
Weingart Plier medium  
Weingart plier that are ideal due to  
their curved tip for setting sheets and  
is capable of bending the ends.  
Length 145mm

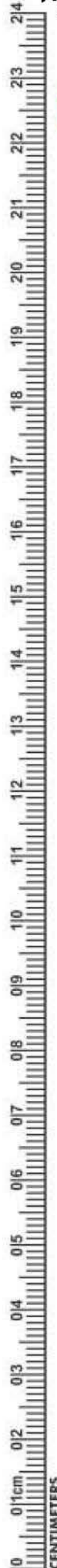





- Инструменты для имплантологии
- Implantologie
- Implantologie

- Інструменти для імплантології
- Implantologia
- زراعة الأسنان

**BLACK TITANIUM COLOUR COATED INSTRUMENTS**

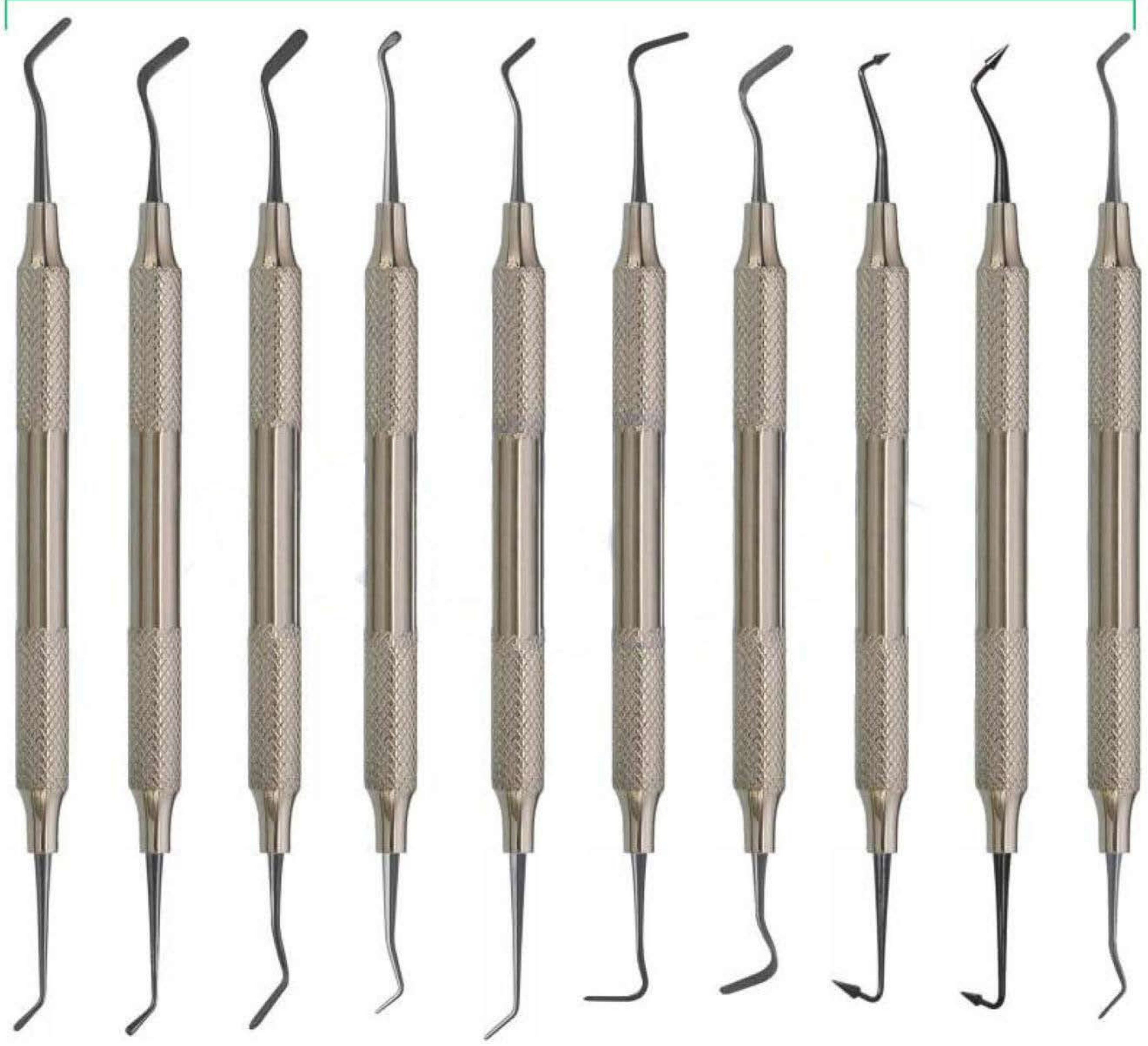
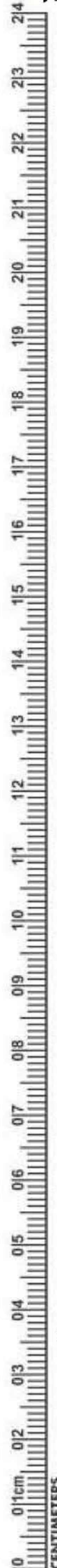

NHS-1455 #1      NHS-1456 #2      NHS-1457 #3 Extra-Flex      NHS-1458 Micro-Mini      NHS-1459 Mini 1      NHS-1460 Mini 4 Extra-Flex      NHS-1461 #4 Extra-Flex      NHS-1462 #5 Flexi-Thin      NHS-1463 #6 Flexi-Thin      NHS-1464 Mini 3 Extra-Flex



# IMPLANTOLOGY

- Инструменты для имплантологии
  - Implantologie
  - Implantologie
- Инструменти для імплантології
  - Implantoloia
  - زراعة الأسنان

## BLACK TITANIUM COLOUR COATED INSTRUMENTS

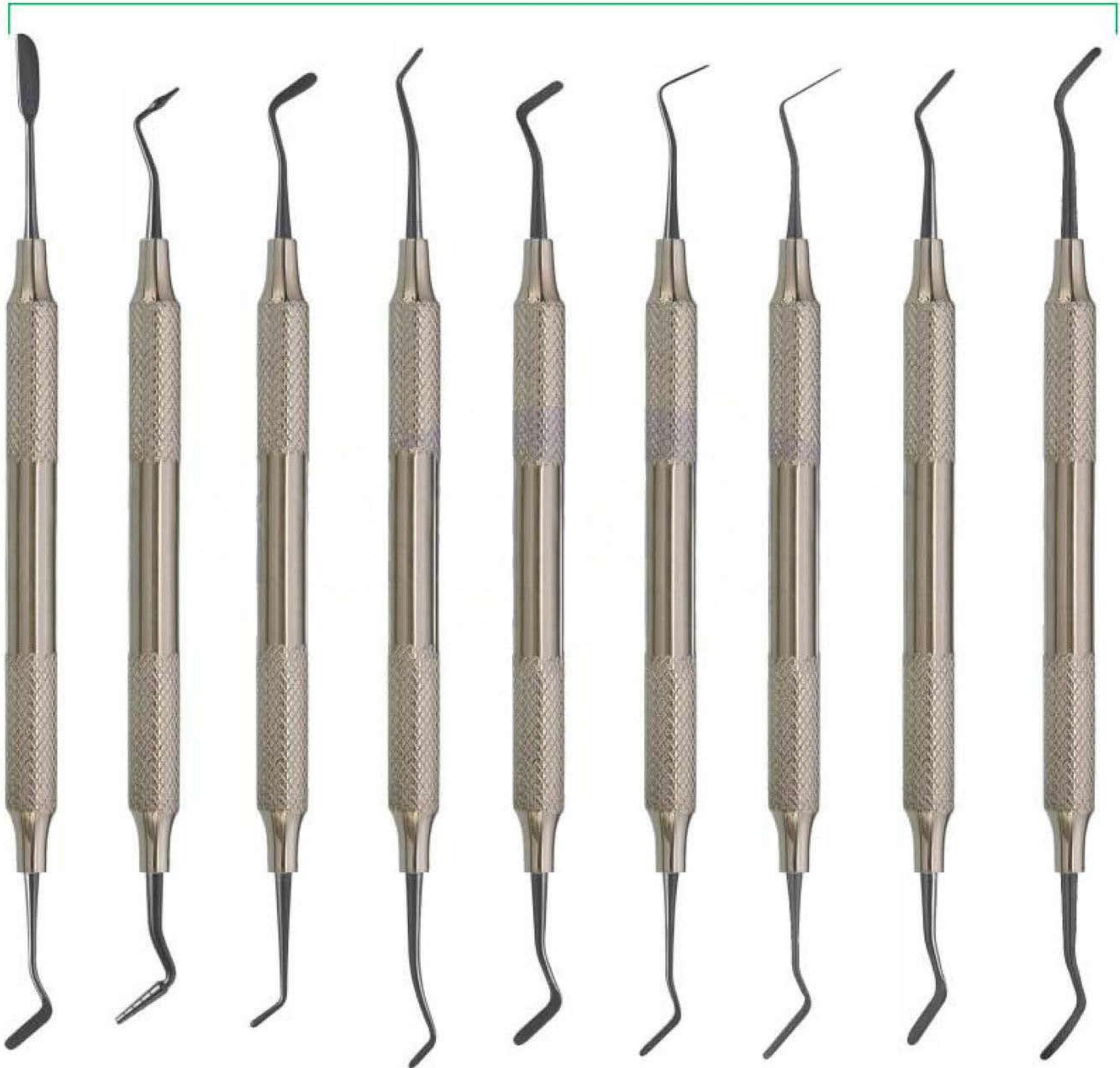

NHS-1465  
AB1  
Boghosian

NHS-1466  
AB2  
Boghosian

NHS-1467  
W3

NHS-1468  
8A

NHS-1469  
4/5  
Gregg

NHS-1470  
Interproximal  
Carver

NHS-1471  
Interproximal  
Carver, Long

NHS-1472  
A6

NHS-1473  
Contouring  
instrument





- Инструменты для имплантологии
- Инструменти для імплантології
- Implantologie
- Implantoloia
- زراعة الأسنان

**BLACK TITANIUM COLOUR COATED INSTRUMENTS**

**BURNISHERS**

**FREEDMAN BURNISHERS**

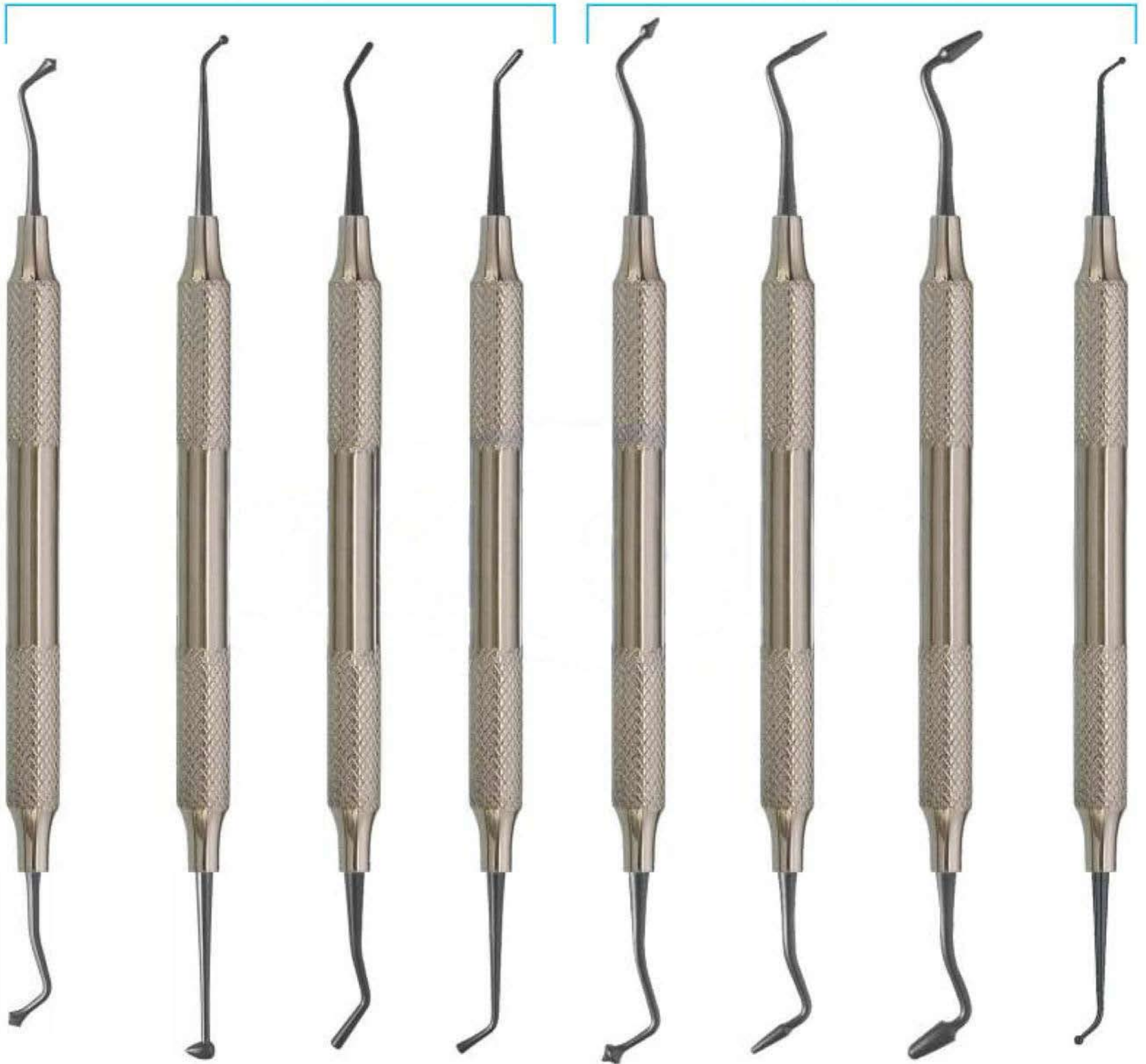
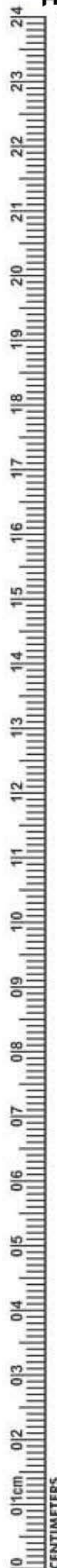

NHS-1474  
21B

NHS-1475  
27/29

NHS-1476  
2  
Ladmore

NHS-1477  
3  
Ladmore

NHS-1478  
Freedman  
"Duckhead"

NHS-1479  
Freedman  
Small Contact  
Forming

NHS-1480  
Freedman  
Large Contact  
Forming

NHS-1481  
Small/  
Medium Ball  
Burnisher



# IMPLANTOLOGY

- Инструменты для имплантологии
  - Implantologie
  - Implantologie
- Инструменти для імплантології
  - Implantoloia
  - زراعة الأسنان

## BLACK TITANIUM COLOUR COATED INSTRUMENTS

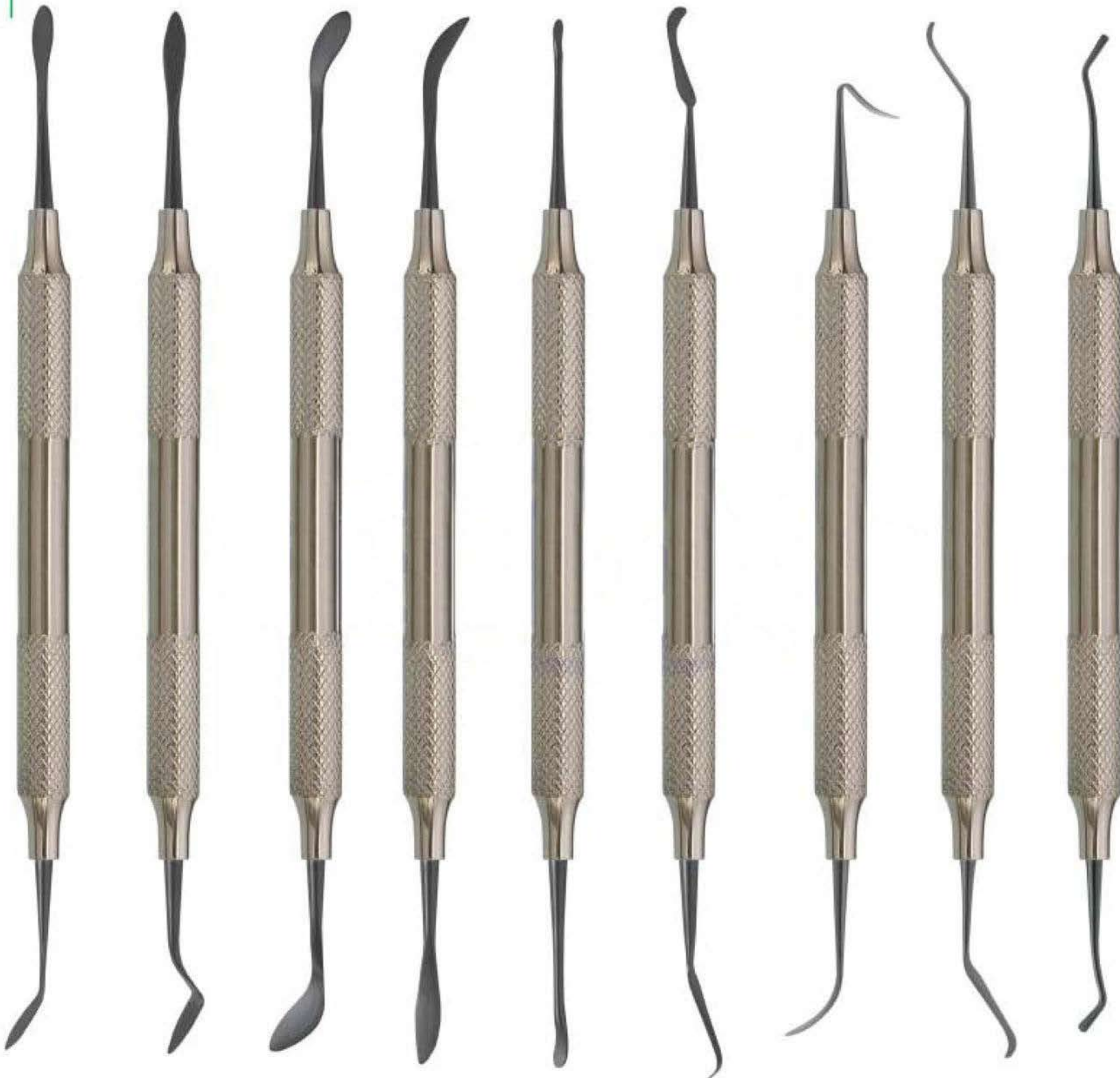

**NHS-1482**  
A  
Cosmetic  
Contouring

**NHS-1483**  
B  
Cosmetic  
Contouring

**NHS-1484**  
C  
Cosmetic  
Contouring

**NHS-1485**  
D  
Cosmetic  
Contouring

**NHS-1486**  
E  
Cosmetic  
Contouring

**NHS-1487**  
F  
Cosmetic  
Contouring

**NHS-1488**  
Marginal Ridge  
& Embrasure  
Shaping Instrument

**NHS-1489**  
Occlusal  
Anatomy  
Instrument

**NHS-1490**  
Composite  
Packing  
Instrument







- Инструменты для имплантологии
- Implantologie
- Implantologie

- Инструменти для імплантології
- Implantologia
- زراعة الأسنان

**BLACK TITANIUM COLOUR COATED INSTRUMENTS**

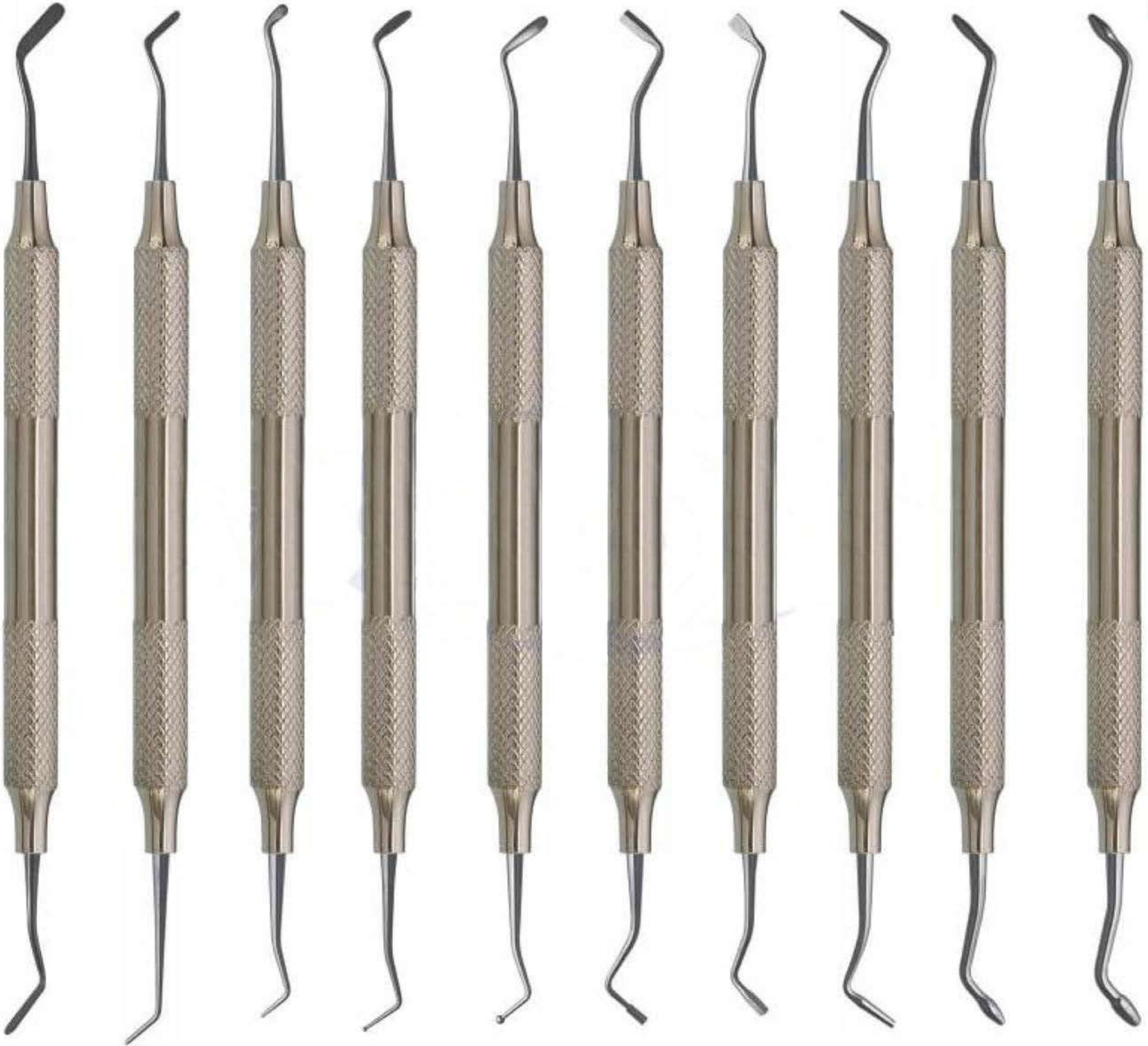
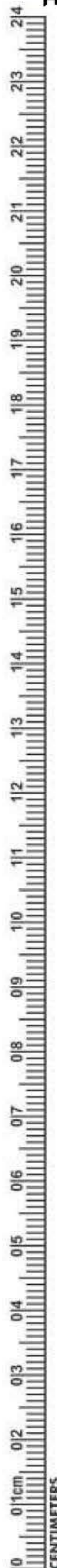

**NHS-1491**  
#3  
Extra-Flex

**NHS-1492**  
Mini 1

**NHS-1493**  
Micro-Mini

**NHS-1494**  
Medium  
Placing/  
Condensing

**NHS-1495**  
Large  
Placing/  
Condensing

**NHS-1496**  
0T  
Tanner

**NHS-1497**  
3  
Hollenback

**NHS-1498**  
5A

**NHS-1499**  
Small/Medium  
Contact  
Forming

**NHS-1500**  
Medium/Large  
Contact  
Forming



- Инструменты для имплантологии
- Implantologie
- Implantologie

- Инструменти для імплантології
- Implantoloia
- زراعة الأسنان

## SINUS LIFT INSTRUMENTS HOLLOW HANDLE 9.5MM LENGTH 170MM

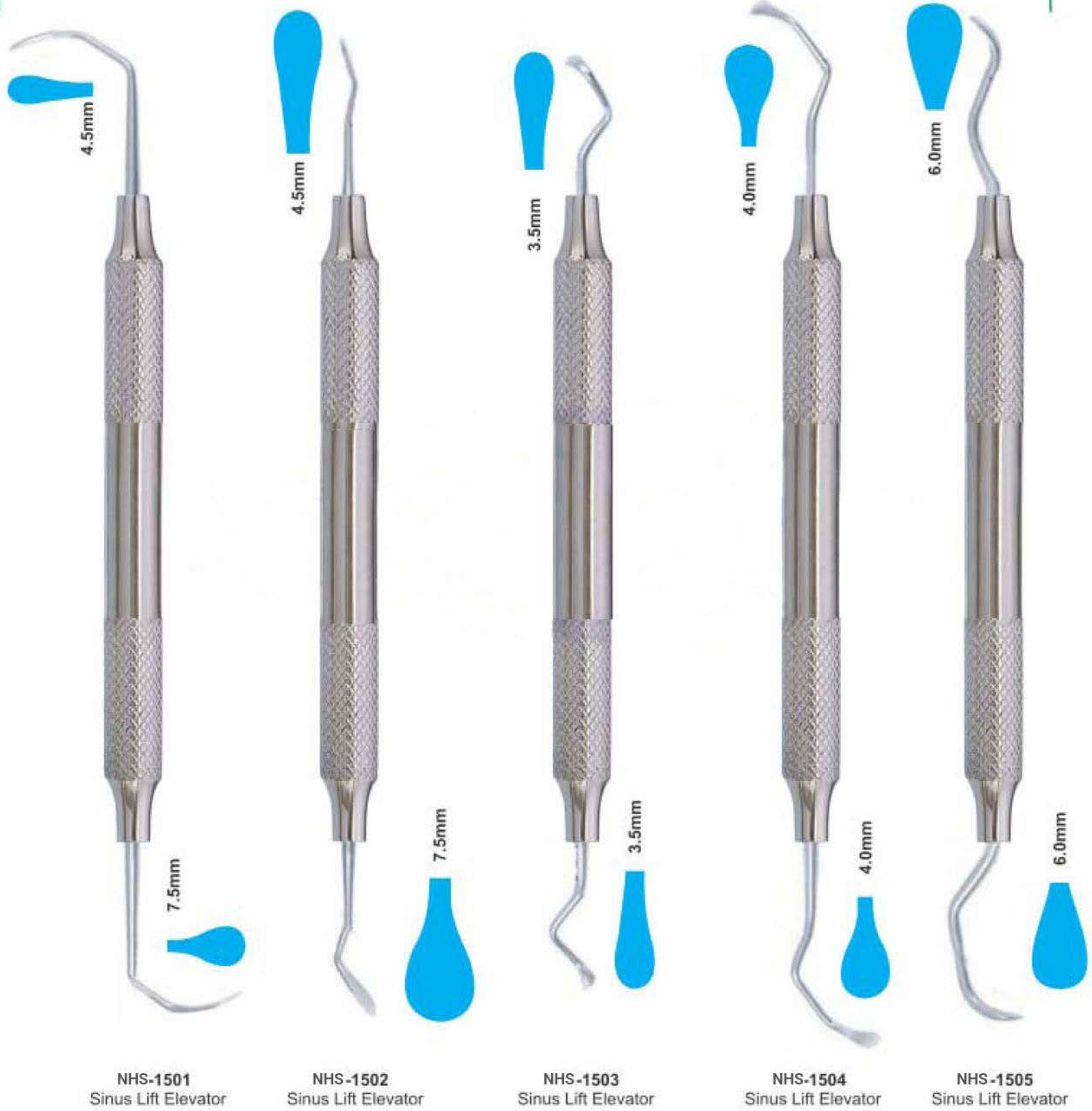



- Инструменты для имплантологии
- Implantologie
- Implantologie

- Инструменти для имплантології
- Implantologia
- زراعة الأسنان

**SINUS LIFT INSTRUMENTS HOLLOW HANDLE 9.5MM LENGTH 170MM**



**NHS-1506**  
Sinus Lift Elevator



**NHS-1507**  
Sinus Lift Elevator



**NHS-1508**  
Sinus Lift Elevator



**NHS-1509**  
Sinus Lift Elevator

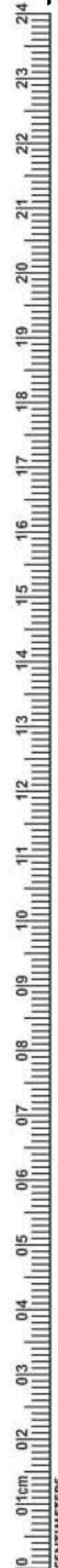



# IMPLANTOLOGY

- Инструменты для имплантологии
- Implantologie
- Implantologie
- Инструменти для імплантології
- Implantologia
- زراعة الأسنان

## IMPLANT SINUS LIFT INSTRUMENTS HOLLOW HANDLE 9.5MM LENGTH 170MM

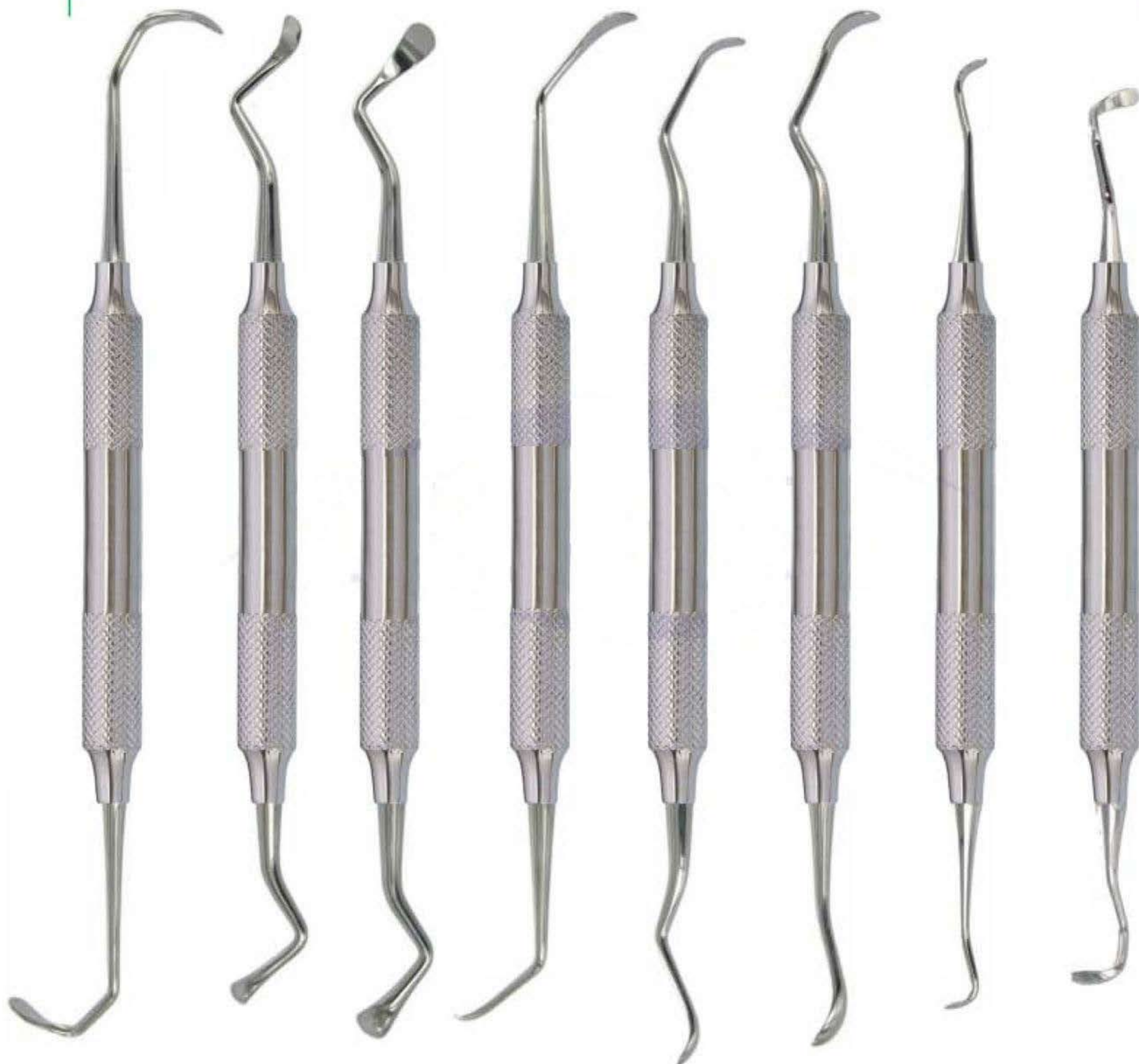

**NHS-1510**  
Acute 6577

**NHS-1511**  
Sinus1

**NHS-1512**  
Sinus2

**NHS-1513**  
Sinus3,  
Obtuse 6578

**NHS-1514**  
Sinus4

**NHS-1515**  
Sinus5

**NHS-1516**  
Sinus6

**NHS-1517**  
Sinus7

INCHES  
0 1 2 3 4 5 6 7 8 9





- Инструменты для имплантологии
- Implantologie
- Implantologie
- Инструменти для імплантології
- Implantologia
- زراعة الأسنان

SINUS LIFT INSTRUMENTS HOLLOW HANDLE 9.5MM LENGTH 170MM

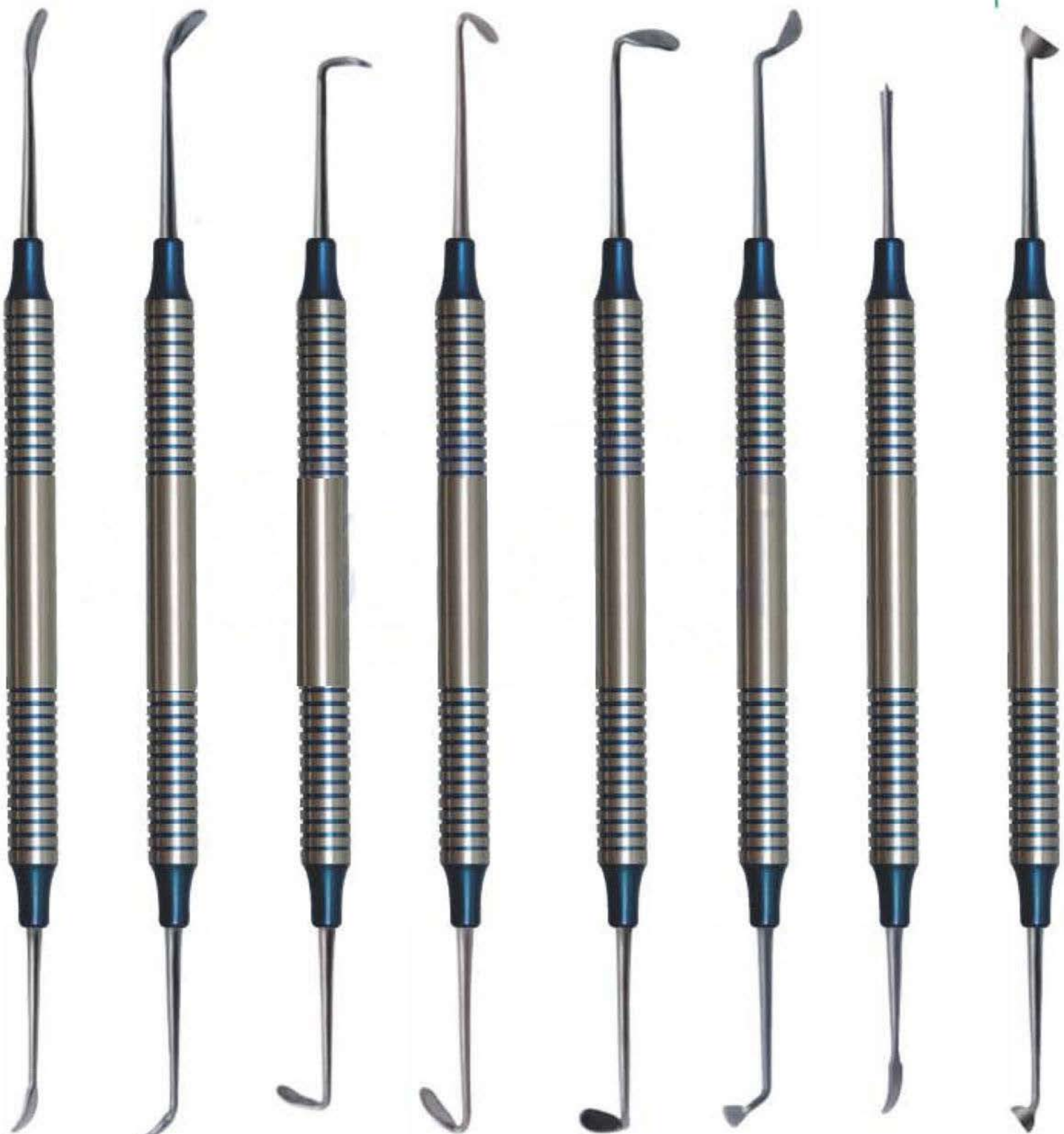
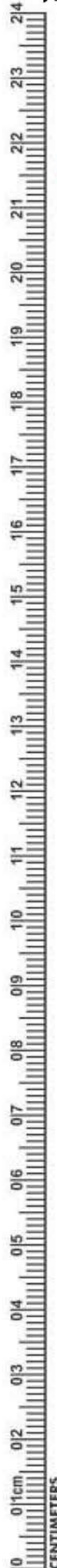

NHS-1518 Sinuslift 1    NHS-1519 Sinuslift 2    NHS-1520 Sinuslift 3    NHS-1521 Sinuslift 4    NHS-1522 Sinuslift 5    NHS-1523 Sinuslift 6    NHS-1524 Membrane 3Positioning 1    NHS-1525 Condenser 1



# IMPLANTOLOGY

- Инструменты для имплантологии
- Implantologie
- Implantologie

- Инструменти для імплантології
- Implantoloia
- زراعة الأسنان

**Sinus Lift Instrument,**  
Flexible Sinus Lift instruments  
reduce the risk of perforation of the  
"Schneider's membrane"



NHS-1526  
Fig. 1

NHS-1527  
Fig. 2

NHS-1528  
Fig. 3

**Sinus Lift Elevator,**  
10 mm Straight grip  
Length 175 mm, Sinus lift elevators, dull,  
for gentle peeling and lifting the  
Schneider membrane



NHS-1529  
Fig. 1

NHS-1530  
Fig. 2

NHS-1531  
Fig. 3

**Sinus lift instrument**  
10 mm Straight grip Length 180 mm,  
Buser (B1, B2, B3) raspatories,  
quality medical stainless steel,  
corrosion-resistant



NHS-1532  
B01

NHS-1533  
B02

NHS-1534  
B03



INCHES



- Инструменты для имплантологии
- Инструменти для імплантології
- Implantologie
- Implantoloia
- Implantologie
- زراعة الأسنان

Sinus lift instrument 10 mm Straight grip Sinus lift elevators, blunt or sharply curved (H01, H02, K03, K04, K78, K77)

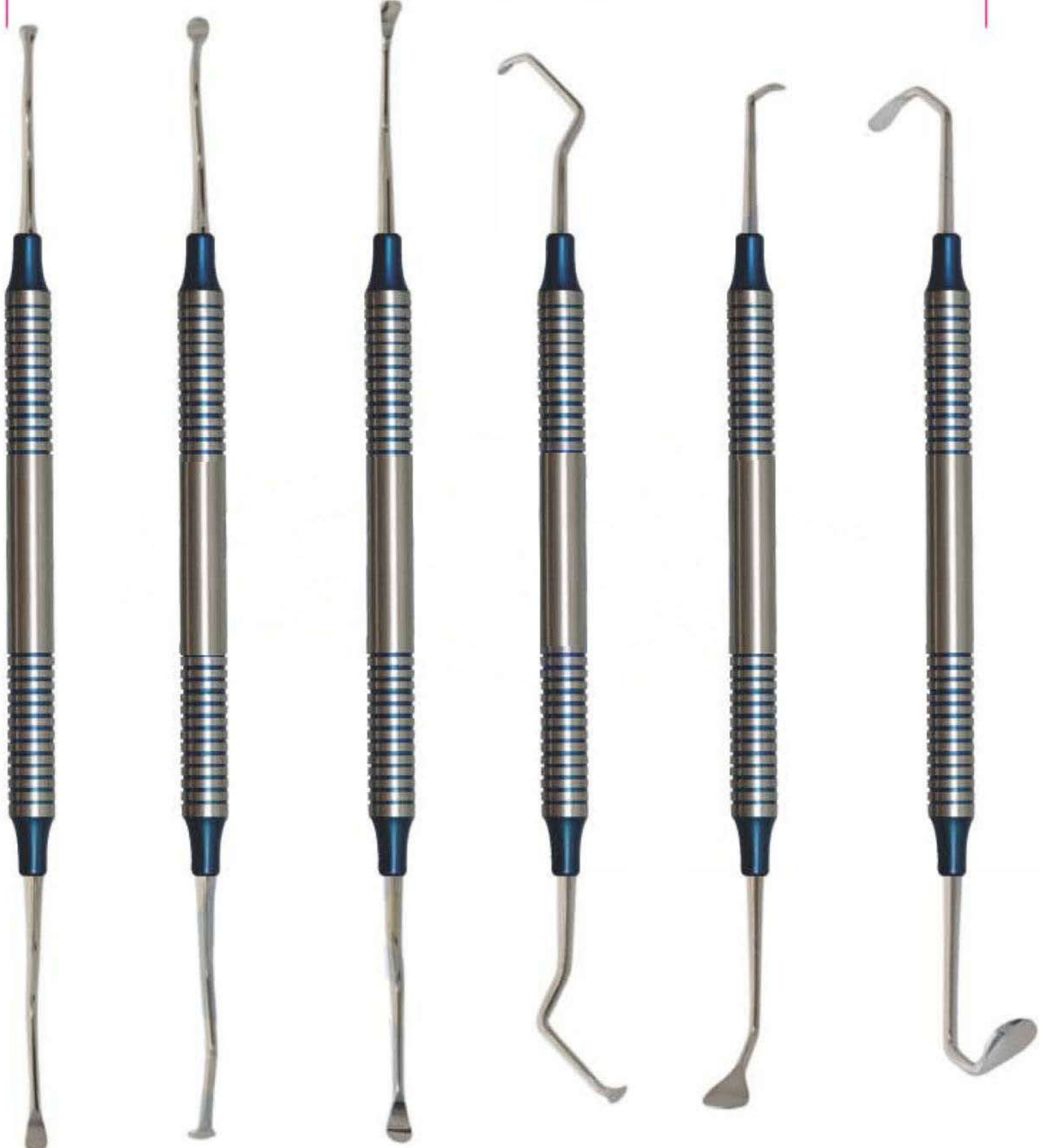

**NHS-1535**  
Sinus lift instrument  
H01

**NHS-1536**  
Sinus lift instrument  
H02

**NHS-1537**  
Sinus lift instrument  
K03

**NHS-1538**  
Sinus lift instrument  
K04

**NHS-1539**  
Sinus lift instrument  
K78

**NHS-1540**  
Sinus lift instrument  
K77



- Инструменты для имплантологии
- Implantologie
- Implantologie

- Инструменти для імплантології
- Implantologia
- زراعة الأسنان

## SINUS LIFT INSTRUMENT

Sinus Lift Elevators, 10 mm Hollow Handle length 170mm Blunt Curved Set of 6 Pcs

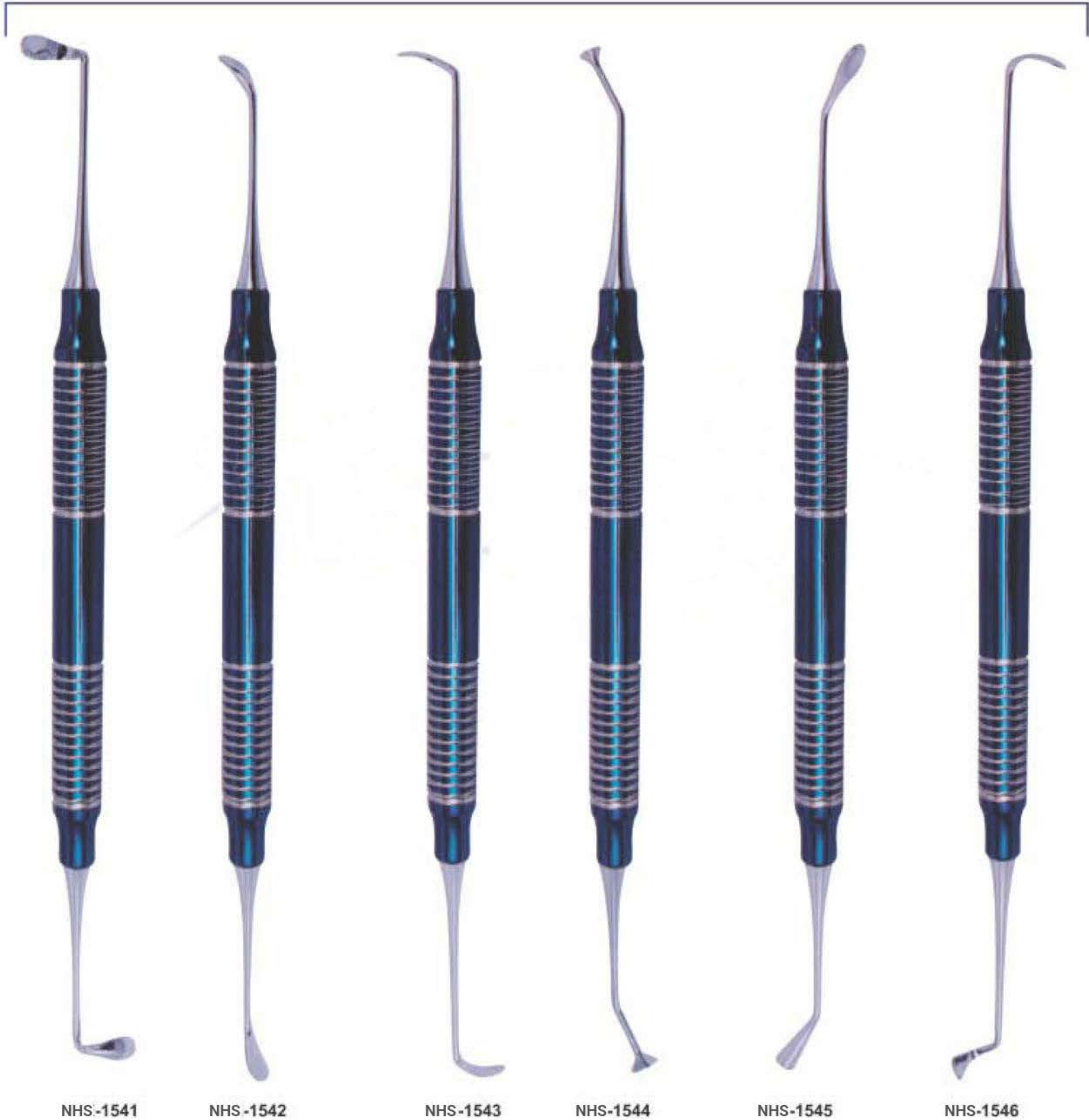

NHS-1541

NHS-1542

NHS-1543

NHS-1544

NHS-1545

NHS-1546





- Инструменты для имплантологии
- Implantologie
- Implantologie

- Инструменти для імплантології
- Implantologia
- زراعة الأسنان

IMPLANT SINUS LIFT INSTRUMENTS  
 PERIODONTAL SURGERY SURGICAL CHISELS  
 KRAMER NEVINS SINUS LIFT

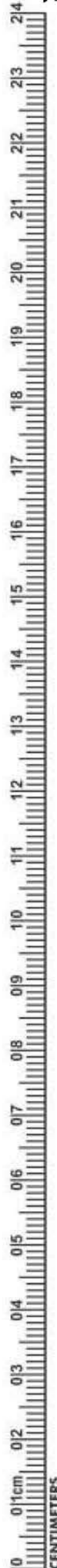
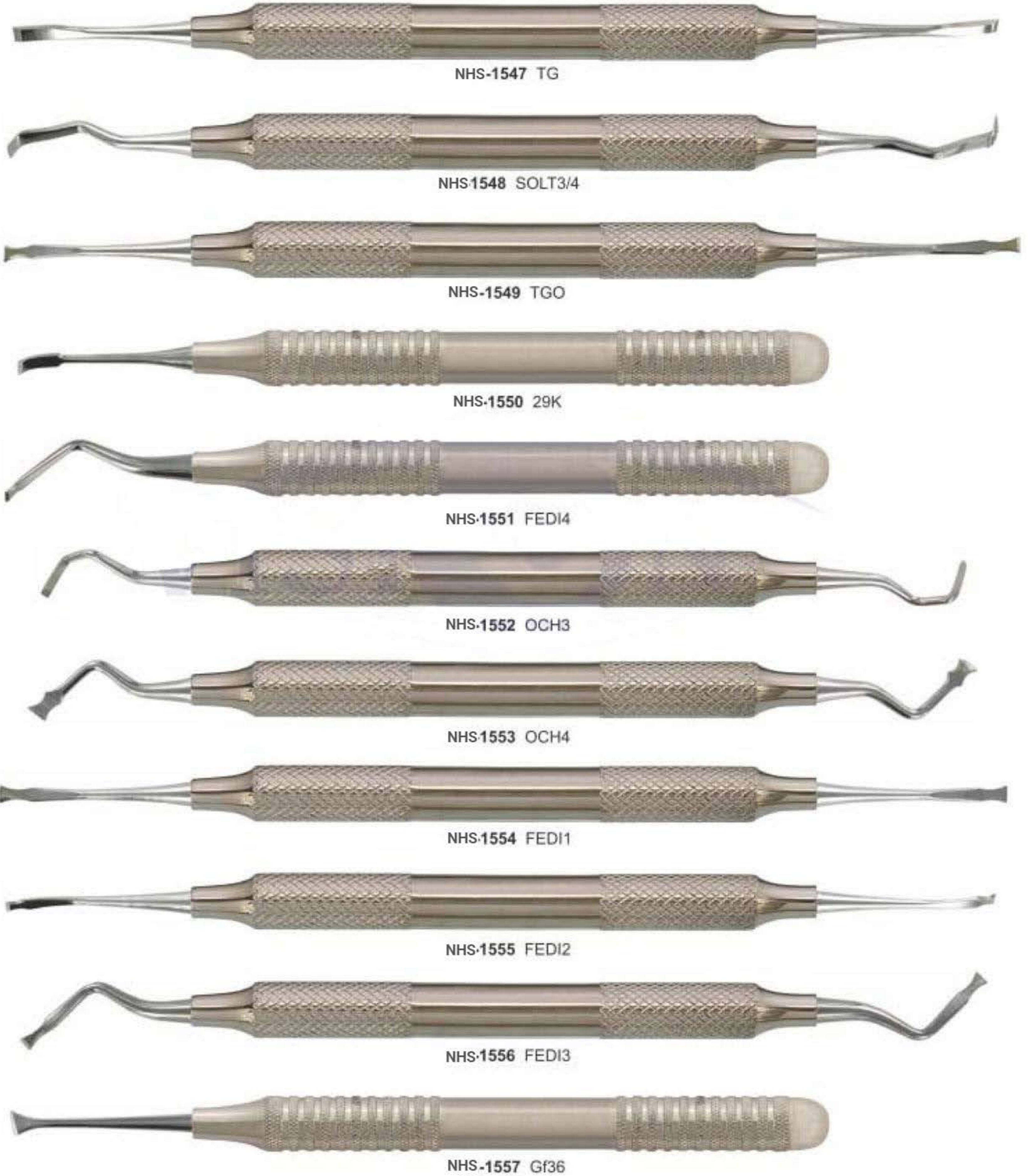



# IMPLANTOLOGY

- Инструменты для имплантологии
- Implantologie
- Implantologie

- Інструменти для імплантології
- Implantologia
- زراعة الأسنان

## IMPLANT

## SURGICAL CHISELS

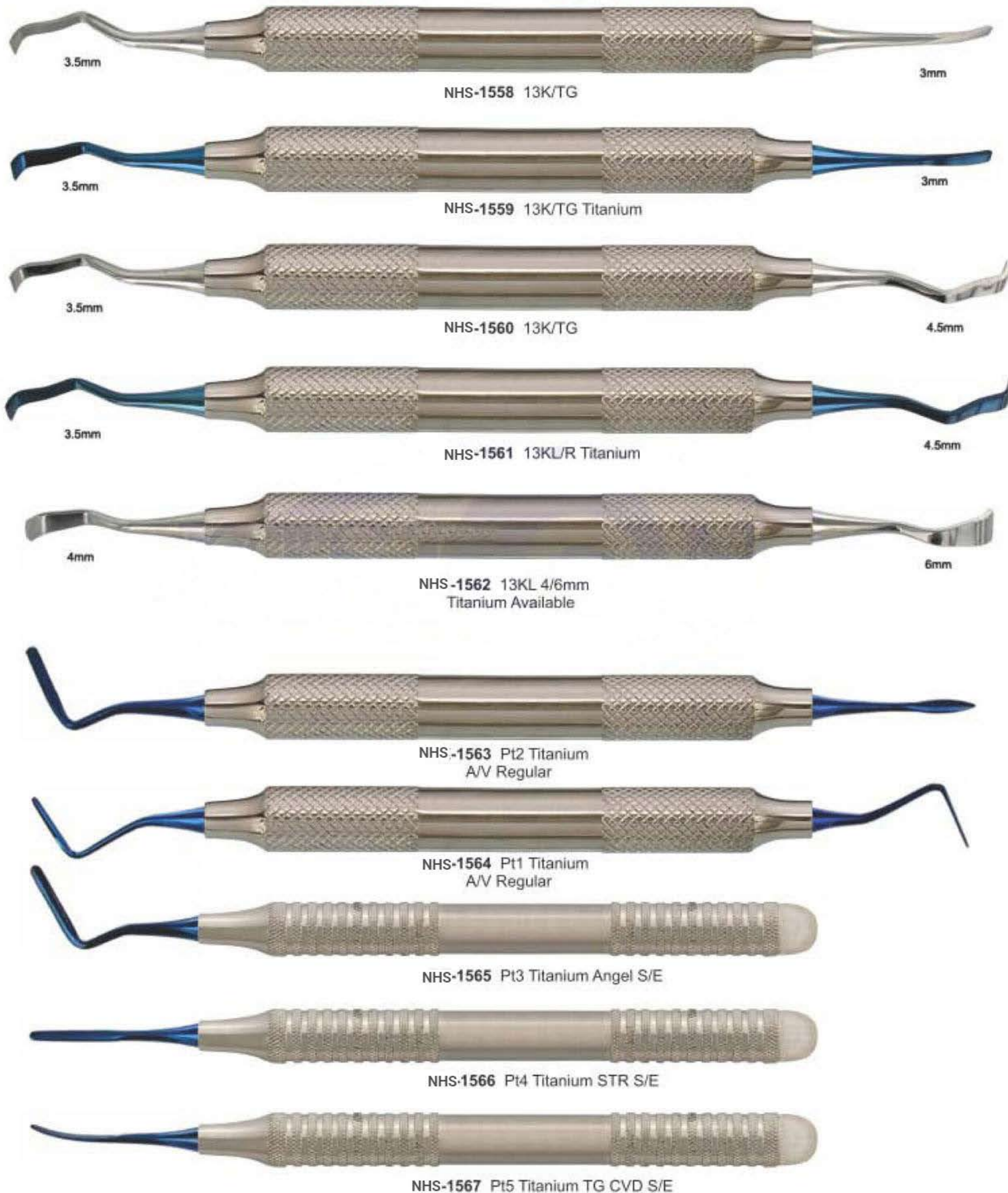





- Инструменты для имплантологии
- Implantologie
- Implantologie

- Інструменти для імплантології
- Implantologia
- زراعة الأسنان

**MIXING SPATULA WITH SHOVEL**



**NHS-1568**  
Bone Carrier  
Titanium



**NHS-1569**  
Raspator, Prichard  
Length 180 mm,  
10 mm hollow handle,  
double-ended  
10.5 mm | 4.5 mm,



**NHS-1570**  
Raspator, Prichard  
Length 180 mm,  
10 mm hollow handle,  
double ended



**NHS-1571**  
Raspator, Prichard  
Length 180 mm,  
10 mm hollow handle,  
double-ended  
10.5 mm | 4.5 mm,



**NHS-1572**  
Mixing Spatula  
with shovel  
17cm



**NHS-1573**  
Mixing Spatula  
with shovel  
18.5cm

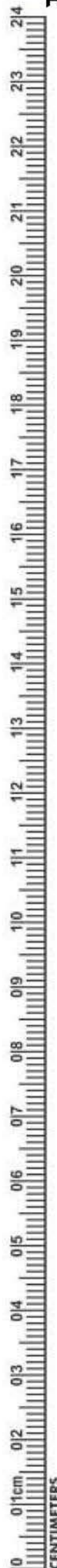



- Инструменты для имплантологии
- Implantologie
- Implantologie
- Инструменти для імплантології
- Implantologia
- زراعة الأسنان

## BONE GRAFTING INSTRUMENTS COMPACTOR /TAMPERS

Product offering includes instruments for harvesting, mixing and compacting bone Provides clinicians with the proper instrumentation for bone grafting procedures Weighted bone basin Prevents tipping and spilling of bone and other materials during mixing



**NHS-1574**  
Graft Packer,  
Concave Tips  
DE 4/6mm

**NHS-1575**  
Bone Spoon/  
Packer DE 3mm

**NHS-1576**  
Graft Packer,  
Serrated Tips  
DE 6/8mm

**NHS-1577**  
Graft Packer,  
Serrated Tips  
DE 3/4mm

**NHS-1578**  
Graft Packer,  
Smooth Tips  
DE 5/8mm

**NHS-1579**  
Titanium graft packer/  
placement site depth  
gauge 3.3mm & 4.0mm  
Diameter tips Marked  
at 8, 11, 13, 15 & 18mm

**NHS-1580**  
Graft Material Spoon  
Concave Tip For  
Larger Grafts





- Инструменты для имплантологии
- Implantologie
- Implantologie
- Инструменти для імплантології
- Implantologia
- زراعة الأسنان

BONE GRAFTING INSTRUMENTS



**NHS-1581**  
Blade and pusher  
Length 180 mm,  
for straight or angled,  
blade: 15 x 5 mm,  
pusher: 4 mm diameter  
Straight

**NHS-1582**  
Blade and pusher  
Length 180 mm,  
for straight or angled,  
blade: 15 x 5 mm,  
pusher: 4 mm diameter  
angular

**NHS-1583**  
Spoon and pusher  
Length 180 mm,  
for angled spoon:  
10 x 5 mm, pusher:  
diameter 3 mm

**NHS-1584**  
Tunnelierungs  
Instrument  
length 175 mm,

**NHS-1585**  
Tunnelierungs  
Instrument  
length 175 mm,  
different designs

**NHS-1586**  
Tamper  
Length 170 mm,  
for bone material,  
double-ended,  
diameter 3.2 mm  
(2-4-6-8-10) and diameter  
2.5mm (2-4-6-8-10)





# IMPLANTOLOGY

- Инструменты для имплантологии
  - Implantologie
  - Implantologie
- Інструменти для імплантології
  - Implantologia
  - زراعة الأسنان

## BONE GRAFTING INSTRUMENTS

**Pluggers Clarizio**  
Length 160 mm, with titanium tips for mixing and pouring of autologous, heterologous bone substitute material, diameter (3/4 or 6/8 mm)



NHS-1587 Ø 4mm  
NHS-1588 Ø 5mm  
Compactor  
150mm



NHS-1589  
Sinus Window  
Bone Tamper  
4 mm



NHS-1590  
Sinus Window  
Bone Tamper  
7 mm



NHS-1591  
6/8mm



NHS-1592  
3/4mm



INCHES





- Инструменты для имплантологии
- Implantologie
- Implantologie
- Instruments for implantology
- Implantoloia
- زراعة الأسنان

SPOON AND PUSHER (TRINOVO)

Trinovo handle, different workers, for bone material, high-grade medical stainless steel, corrosion-resistant

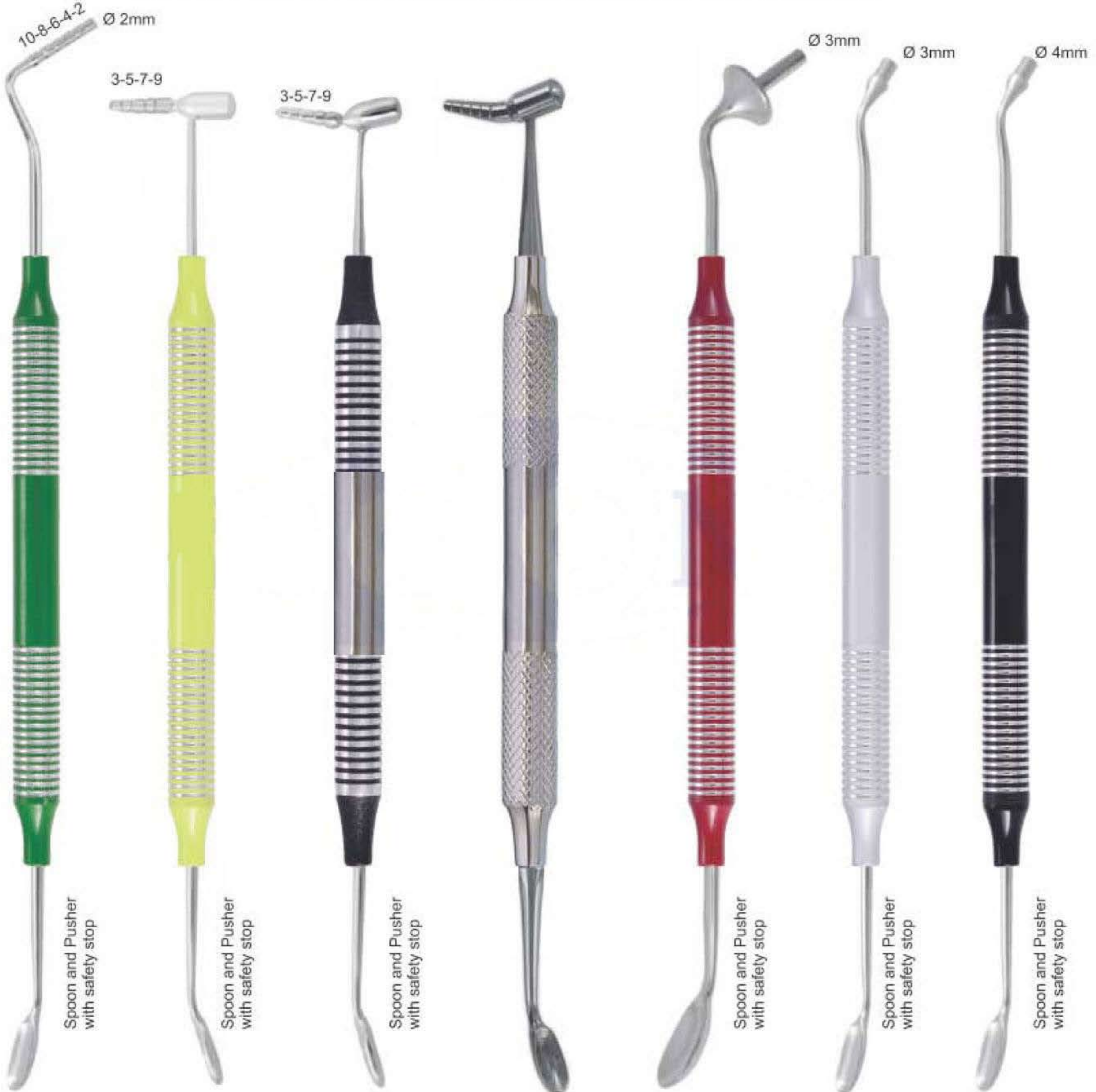
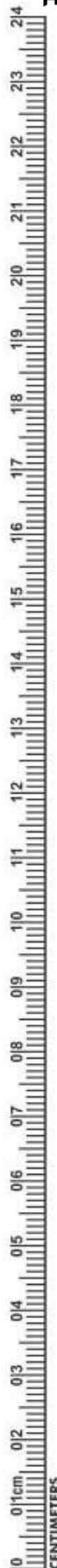

NHS-1593 10x5mm  
 NHS-1594 10x5mm  
 NHS-1595 10x5mm  
 NHS-1596 Bone Graft/Carrier Titanium 2-4-6-8-10mm  
 NHS-1597 15x10mm  
 NHS-1598 10x5mm  
 NHS-1599 10x5mm



- Инструменты для имплантологии
- Implantologie
- Implantologie
- Инструменти для імплантології
- Implantologia
- زراعة الأسنان

## PERIOSTEALS ELEVATOR 10mm Hollow Handle

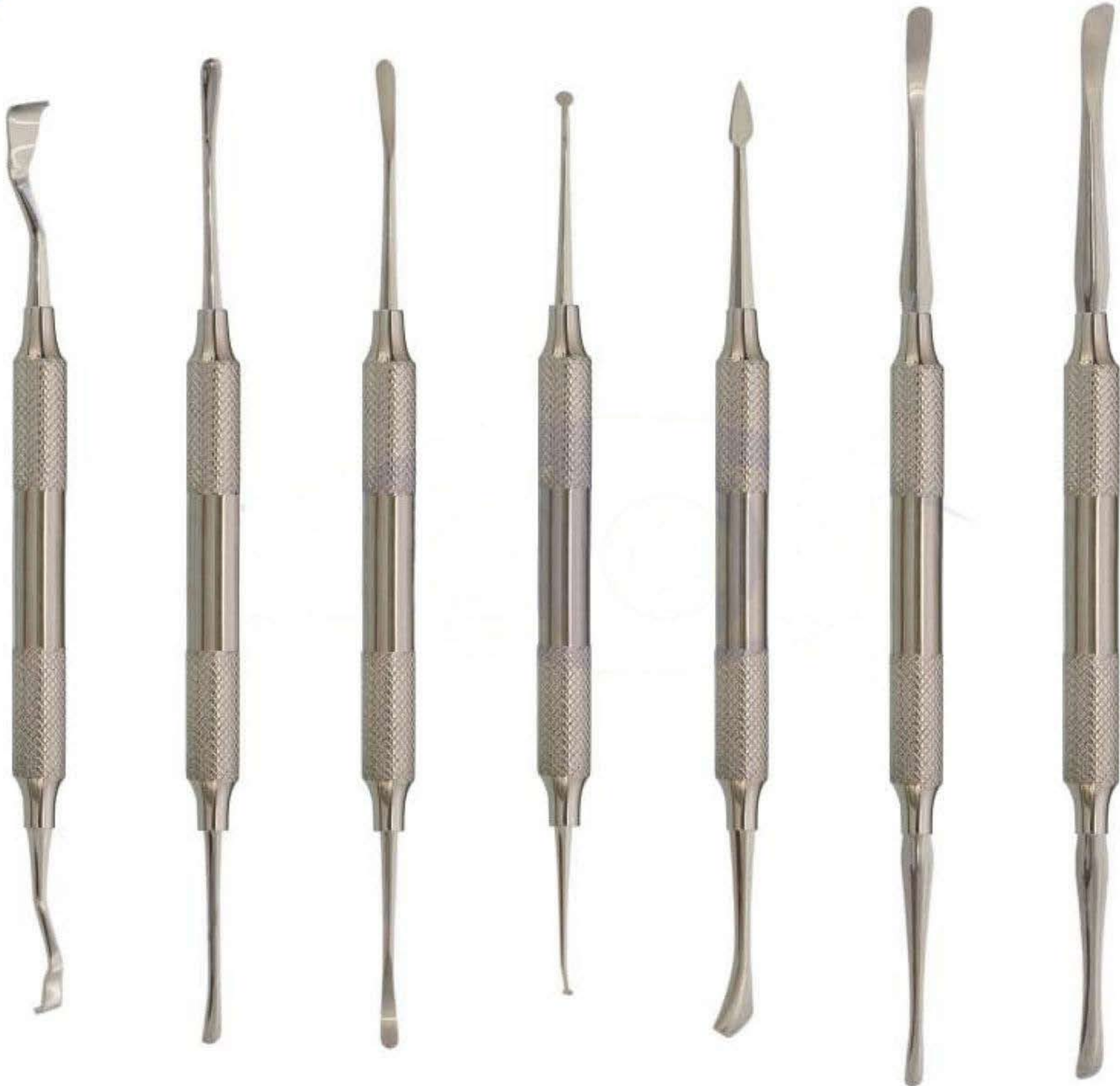

**NHS-1600**  
Raspator,  
BonexScraper  
Length 165 mm,  
10 mm hollow  
handle,  
double-ended 6  
mm / 4 mm,

**NHS-1601**  
Raspator,  
Raspatory  
Length 180 mm,  
10 mm hollow  
handle,  
double-ended  
3 mm | 3 mm,

**NHS-1602**  
Raspator,  
Raspatory  
Length 180 mm,  
10 mm hollow  
handle,  
double-ended  
3 mm | 3 mm,

**NHS-1603**  
Raspator,  
Papilla  
Length 185 mm,  
10 mm hollow  
handle,  
double-ended  
3 mm | 2 mm,

**NHS-1604**  
Raspator,  
bone scraper  
Length 175 mm,  
10 mm hollow  
handle,  
double-ended,

**NHS-1605**  
Raspator,  
micro-Freer  
Length 180 mm,  
6 mm solid grip,  
double-ended  
3 mm | 4 mm

**NHS-1606**  
Raspator,  
Freer  
Length 180 mm,  
6 mm solid  
handle,  
double-ended  
5 mm | 5 mm,



INCHES



- Инструменты для имплантологии
- Инструменти для імплантології
- Implantologie
- Implantoloia
- Implantologie
- زراعة الأسنان

**PERIOSTEALS ELEVATOR 10mm Hollow Handle**

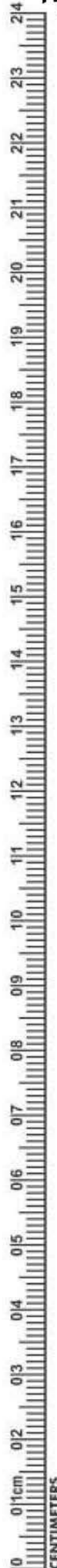

**NHS-1607**  
**Raspator, Freer**  
10 mm hollow handle, high-quality medical double ended



**NHS-1608**  
**Raspator, Molt**  
Length 180 mm, 8 mm solid grip, double-ended 6 mm



**NHS-1609**  
**Raspator, micro Freer**  
Length 185 mm, 10 mm hollow handle, double-ended,



**NHS-1610**  
**Raspator, micro Freer**  
Length 185 mm, 10 mm hollow handle, double-ended,



**NHS-1611**  
**Raspator, micro Raspator / chisel**  
Length 170 mm, 10 mm hollow handle, double-ended,



**NHS-1612**  
**Raspator, micro Raspator / chisel**  
Length 175 mm, 10 mm hollow handle, double-ended,



**NHS-1613**  
**Raspator, Micro Raspator / chisel**  
Length 175 mm, 8 mm solid handle, double-ended 3.5mm | 3.5 mm,



- Инструменты для имплантологии
- Implantologie
- Implantologie

- Инструменти для імплантології
- Implantologia
- زراعة الأسنان

## PERIOSTEALS ELEVATOR 10mm Hollow Handle



**NHS-1614**  
Raspatory Micro Molt  
Length 175 mm,  
corrosion-resistant

**NHS-1615**  
Raspatory Chipping  
Workers:  
Chisel 24G and 7.5 mm,  
length about 175 mm,  
corrosion-resistant

**NHS-1616**  
Raspatory MOLT  
Work ends:  
5.0 mm and 4.0 mm,  
length about 175 mm,  
corrosion-resistant

**NHS-1617**  
Rasp, Molt M9  
Length 175 mm,  
corrosion-resistant

**NHS-1618**  
Raspator, WAUTIER  
Length 175 mm,  
corrosion-resistant

**NHS-1619**  
Raspator, BENQUE  
Length 170 mm,  
workers  
5 mm | 7 mm,  
corrosion-resistant

**NHS-1620**  
Raspator, Nordberg  
Length 180 mm,  
8 mm hollow handle,  
double-ended  
6 mm | 4 mm





- Инструменты для имплантологии
- Implantologie
- Implantologie

- Инструменти для імплантології
- Implantologia
- زراعة الأسنان

Hollow Handle 10mm Length 170mm

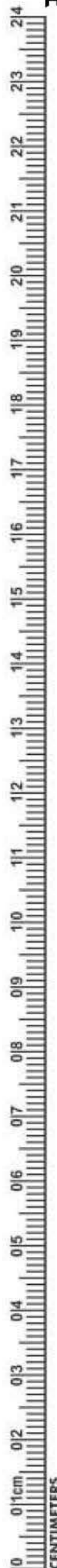



# IMPLANTOLOGY

- Инструменты для имплантологии
- Implantologie
- Implantologie
- Инструменти для імплантології
- Implantoloia
- زراعة الأسنان

## TISSUE MEMBRANE FORCEPS



**NHS-1630**  
Tissue Graft Forcep  
Serrated Teeth



**NHS-1631**  
Self Locking  
Grooved



**NHS-1632**  
Tissue Graft Forcep  
Serrated Teeth



**NHS-1633**  
Titanium  
Locking Plier



**NHS-1634**  
TC Gripper Carbide  
Tipped Tissue Forceps  
Serrated Carbide Tips  
14.5cm



**NHS-1635**  
Adson Carbide  
Tipped Tissue Forceps  
Serrated Carbide Tips  
12cm



**NHS-1636**  
Micor Adson 1x2  
Tissue Forcep 12.1cm  
1x2 Teeth - 0.5mm Tips



**NHS-1637**  
Adson 7x7  
Tissue Forceps  
7x7 Teeth 12cm



**NHS-1638**  
Adson 7x7 Curved  
Tissue Forceps  
7x7 Teeth 12cm



**NHS-1639**  
Suture Pliers  
Suture Forceps with  
1.6mm Ring Tip



**NHS-1640**  
Debakey Atraumatic  
Tissue Forceps Straight  
Serrated Teeth  
16cm



**NHS-1641**  
Debakey Atraumatic  
Tissue Forceps Curved  
Serrated Teeth  
16cm







- Инструменты для имплантологии
- Implantologie
- Implantologie

- Инструменти для імплантології
- Implantoloia
- زراعة الأسنان

TISSUE MEMBRANE FORCEPS



NHS-1642 Russian Long Tissue Forceps Serrated Tip 20cm



NHS-1643 Russian Tissue Forceps Serrated Tip 15cm



NHS-1644 Tissue Punch Forceps To Remove Tissue After Using Punch



NHS-1645 13.5 cm narrow Membrane tweezers KUEHNE



NHS-1646 10.5 cm wide Membrane tweezers KUEHNE



NHS-1647 13.5 cm wide Membrane tweezers KUEHNE



NHS-1648 Pin-Tweezers with or without lock, length 15 cm, with lock



NHS-1649 Haltepinzette without lock



NHS-1650 Haltepinzette with lock 15.5 cm, for pins, towards the tips, etc.



NHS-1651 Carry Forceps 15cm



NHS-1652 Carry Forceps 15cm



NHS-1653 Carry Forceps 15cm

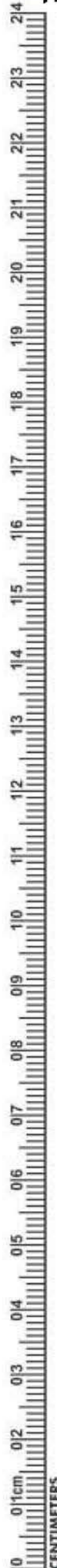



# IMPLANTOLOGY

- Инструменты для имплантологии
- Implantologie
- Implantologie
- Инструменти для імплантології
- Implantologia
- زراعة الأسنان

## OSTEOTOME CONVEXES / CONCAVE / CONIQUES

CONVEXES

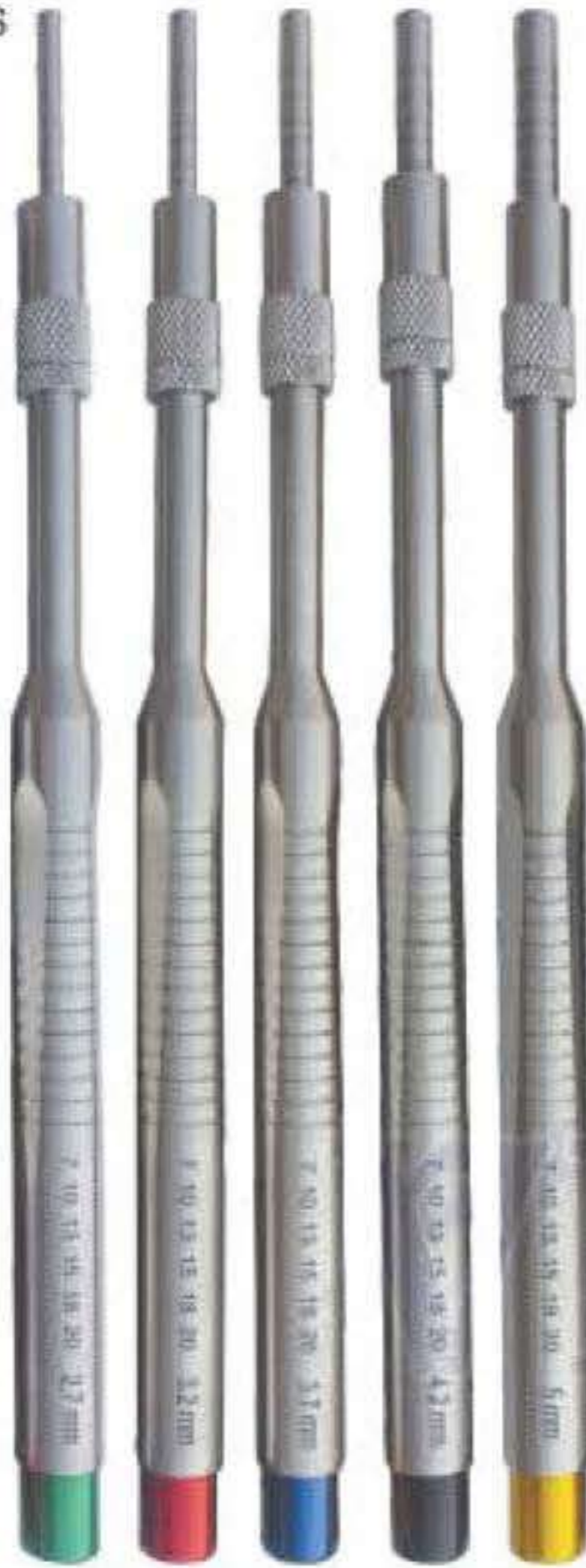

**NHS-1654**  
**SET OF 5 PIECES**

CONCAVES



**NHS-1655**  
**SET OF 5 PIECES**

CONIQUES



**NHS-1656**  
**SET OF 5 PIECES**

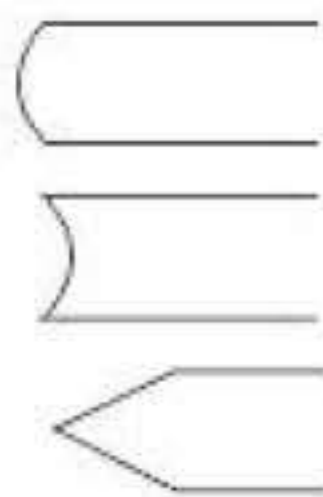
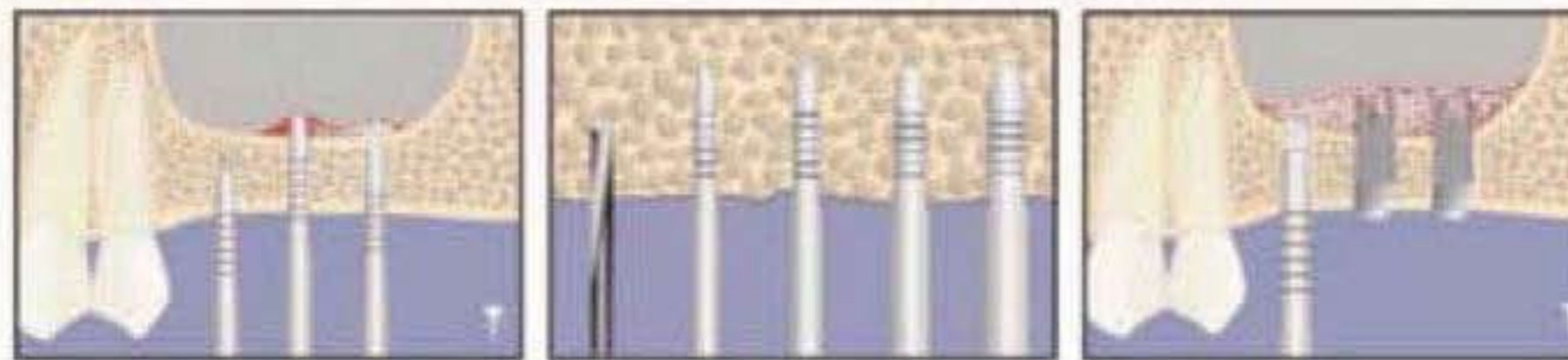

CONVEXES STRAIGHT	NHS-1654	2,7 Ømm	3,2 Ømm	3,7 Ømm	4,2 Ømm	5 Ømm
CONCAVES STRAIGHT	NHS-1655	2,7 Ømm	3,2 Ømm	3,7 Ømm	4,2 Ømm	5 Ømm
CONIQUES STRAIGHT	NHS-1656	2,7 Ømm	3,2 Ømm	3,7 Ømm	4,2 Ømm	5 Ømm







- Инструменты для имплантологии
- Instrumentologie
- Implantologie
- Инструменти для имплантології
- Implantoloia
- زراعة الأسنان

**OSTEOTOME CONVEXES / CONCAVE / CONIQUES**

CONVEXES



**NHS-1657**  
**SET OF 5 PIECES**

CONCAVES



**NHS-1658**  
**SET OF 5 PIECES**

CONIQUES



**NHS-1659**  
**SET OF 5 PIECES**

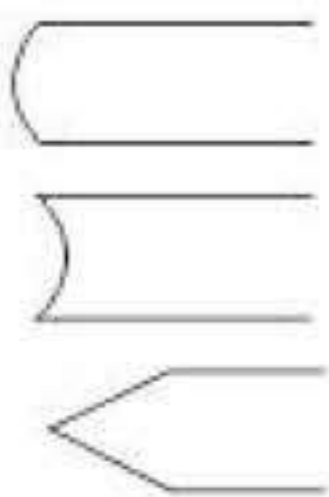
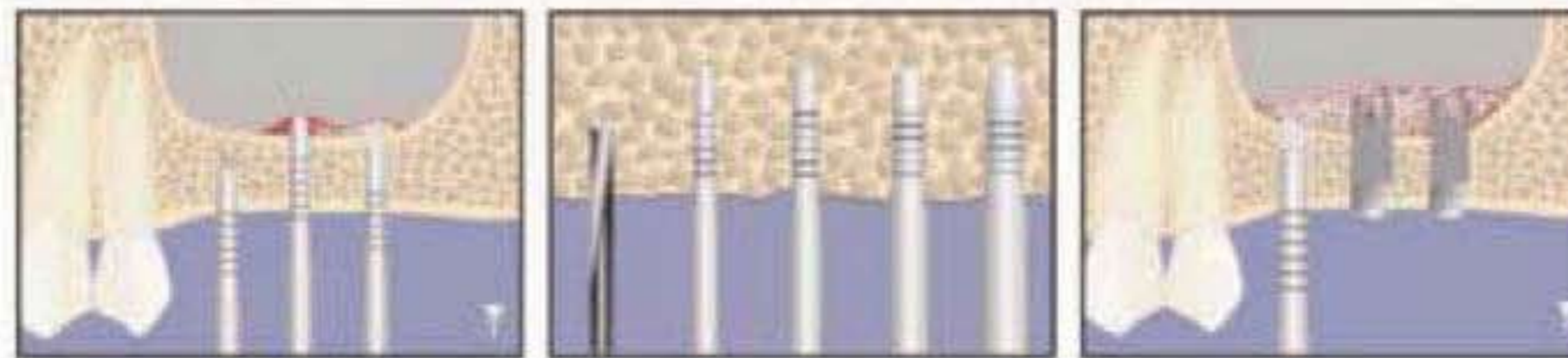

CONVEXES CURVED	NHS-1657	2,7 Ømm	3,2 Ømm	3,7 Ømm	4,2 Ømm	5 Ømm
CONCAVES CURVED	NHS-1658	2,7 Ømm	3,2 Ømm	3,7 Ømm	4,2 Ømm	5 Ømm
CONIQUES CURVED	NHS-1659	2,7 Ømm	3,2 Ømm	3,7 Ømm	4,2 Ømm	5 Ømm

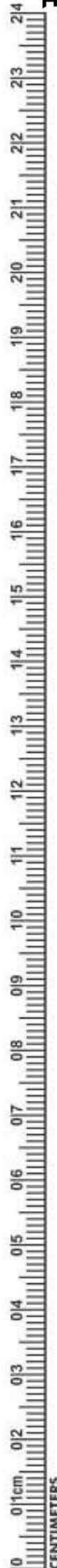



# IMPLANTOLOGY

- Инструменты для имплантологии
- Implantologie
- Implantologie

- Инструменти для імплантології
- Implantoloia
- زراعة الأسنان

## TREPINE

Burs with depth markings are suited for precise and simple transplantation of cylindrical bone grafts as well as for all other bone-extraction tasks.



**NHS-1669**  
Tissue Punch with pin  
Set of Four Pieces



**NHS-1670**  
Tissue Punch  
Set of Five Pieces



**NHS-1671**  
Tissue Punch  
Set of Five Pieces



**NHS-1672**  
Trephine Drill  
Set of Eight Pieces



Ø2.0mm   Ø2.5mm   Ø2.8mm

**NHS-1673**  
Short Implant Drills

Ø3.2mm   Ø3.65mm   Ø4.2mm   Ø5.2mm

**NHS-1674**  
Long Implant Drills



**NHS-1675**  
Trephine Drill  
Set of Eight Pieces





- Инструменты для имплантологии
- Implantologie
- Implantologie

- Инструменти для імплантології
- Implantologia
- زراعة الأسنان

**BONE SCRAPER STRAIGHT & CURVED**



**NHS-1676**  
Bone Scraper  
Straight

**NHS-1677**  
Bone Scraper  
Curved

**TISSUE PUNCH STRAIGHT & CURVED**



**NHS-1678**  
Tissue Punch  
Straight



**NHS-1685**  
Tissue Punch  
Curved

- |                        |                        |
|------------------------|------------------------|
| ●<br>NHS-1679<br>2.0mm | ●<br>NHS-1680<br>4.0mm |
| ●<br>NHS-1681<br>5.0mm | ●<br>NHS-1682<br>6.0mm |
| ●<br>NHS-1683<br>7.0mm | ●<br>NHS-1684<br>8.0mm |

- |                        |                        |
|------------------------|------------------------|
| ●<br>NHS-1686<br>2.0mm | ●<br>NHS-1687<br>4.0mm |
| ●<br>NHS-1688<br>5.0mm | ●<br>NHS-1689<br>6.0mm |
| ●<br>NHS-1690<br>7.0mm | ●<br>NHS-1691<br>8.0mm |



**NHS-1692**  
Bone Mill



**NHS-1693**  
Basins For Bone



**BONE CRUSHER**  
NHS-1694

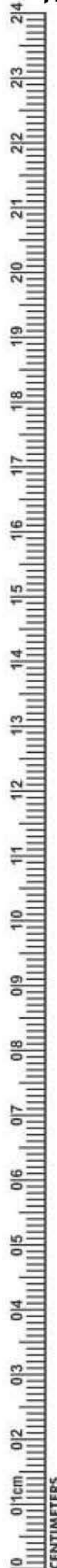



# IMPLANTOLOGY

- Инструменты для имплантологии
  - Implantologie
  - Implantologie
- Інструменти для імплантології
  - Implantologia
  - زراعة الأسنان

## KEYS FOR IMPLANT SCREW



## TORQUE WRENCH & RATCHET







- Инструменты для имплантологии
- Implantologie
- Implantologie
- Инструменти для імплантології
- Implantologia
- زراعة الأسنان



NHS-1717 BONE CRUSHER Titanium Metal Cutter

mallet



NHS-1718 BONE CRUSHER Titanium Metal Cutter

mallet

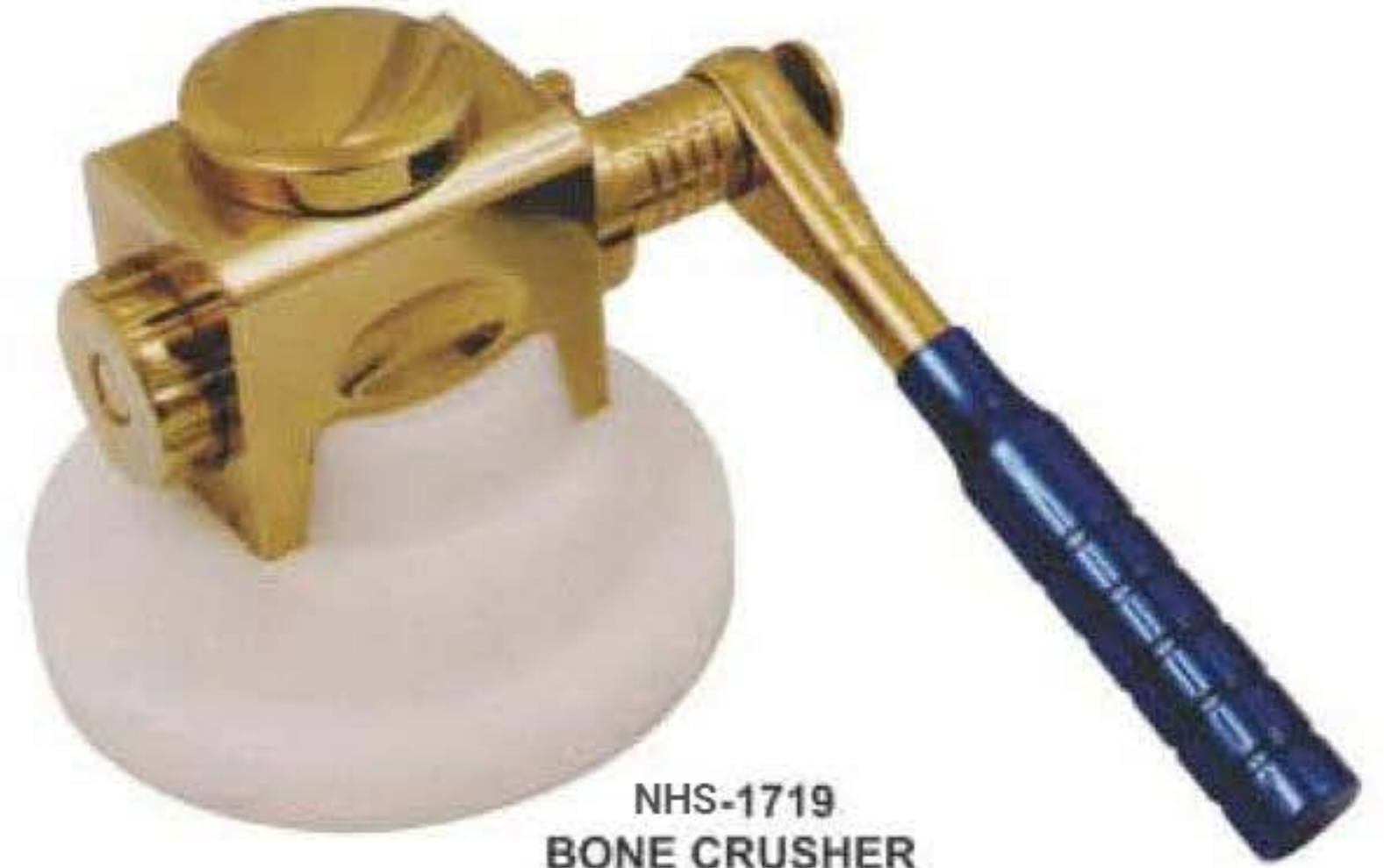

NHS-1719 BONE CRUSHER



NHS-1720 BONE CRUSHER Bone Grinding Grain 1.5mm, 2mm, 2.5mm



NHS-1721 BONE CRUSHER Bone Grinding Grain 1.5mm, 2mm, 2.5mm

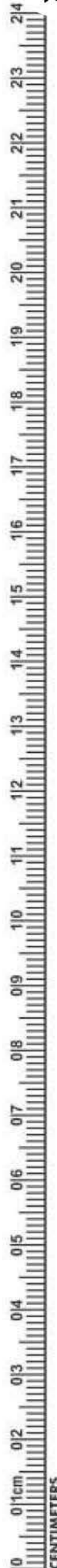



## IMPLANTOLOGY

- Инструменты для имплантологии
  - Implantologie
  - Implantologie
- Інструменти для імплантології
  - Implantologia
  - زراعة الأسنان

### BONE EXPANDER SCREW & SURGICAL KITS



**NHS-1722**  
Bone Universal Kit  
Drill: 2mm, 2.8mm, 3.2mm, 3.65mm,  
4.2mm, 4.5mm, 4.8mm, 5.2mm  
Trepines Bit:  
3.0mm, 4.0mm, 5.0mm, 6.0mm,  
7.0mm, 8.0mm, 9.0mm, 10mm.  
Driver:  
2.5mm, 2.5mm Hand Pcs  
1.25mm, 1.25mm Hand Pcs  
Short Driver 2.5mm  
Long Driver 2.5mm  
1.25mm, Short Hex Driver Hand Pcs  
1.25mm, Long Hex Driver Hand Pcs  
Torque Wrench 4.0mm



**NHS-1723**  
Bone Expander Kit  
Expander: 2.6mm, 3.0mm,  
3.4mm, 3.8mm, 4.3mm  
Ratchet Driver  
Parallel Pin  
Pilot Drill  
Drill 1.4mm  
Drill Driver 4mm  
Hand Driver 4mm  
Ratchet 4.0mm



**NHS-1724**  
Bone Universal Kit  
Drill: 2mm, 2.8mm, 3.2mm, 3.65mm,  
4.2mm, 4.5mm, 4.8mm, 5.2mm  
Trepines Bit:  
3.0mm, 4.0mm, 5.0mm, 6.0mm,  
7.0mm, 8.0mm, 9.0mm, 10mm.

Bone Compression:  
2mm, 3.3mm, 2.8mm, 4.2mm, 3mm, 3.5mm  
Driver:  
2.5mm, 2.5mm Hand Pcs  
1.25mm, 1.25mm Hand Pcs  
Short Driver 2.5mm  
Long Driver 2.5mm  
1.25mm, Short Hex Driver Hand Pcs  
1.25mm, Long Hex Driver Hand Pcs  
Torque Wrench 6.35mm 1 Pcs



**NHS-1725**  
Conical Drills: 20 Pcs  
Tissue Punches:  
3.0mm, 3.50mm, 4.0mm, 4.5mm,  
5.0mm, 6.0mm, 6.50mm  
Bone Expander:  
1.6/3.8mm, 1.9/3.0mm, 2.1/3.6mm,  
2.6/3.8mm, 2.9/4.3mm  
Drill Adapter: 1 Pcs  
1.25mm, 2.50mm Hex Driver Hand Pcs

Pilot Drill: 1.6mm  
Drill Bit: 1.4mm, 1.6mm, 1.8mm, 2.0mm, 2.2mm  
Ratchet Driver: 4mm/6.35, 1.25/2.50  
Rimer: 3.2/4.7mm, 3.7/4.7mm  
Parallel Pin: 4.5mm, 2.5mm  
Double step Drill: 2.4/2.8mm  
Depth Gauge: 1 Pcs  
Torque Wrench 6.35mm Universal: 1 Pcs





- Инструменты для имплантологии
- Instrumentologie
- Implantologie
- Инструменти для імплантології
- Implantoloia
- زراعة الأسنان

BONE INJECTORS, COLLECTORS & SUCTION TUBE

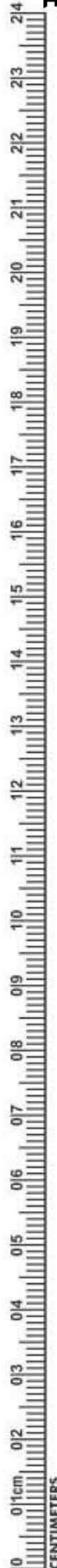

NHS-1726  
Ø 2,5mm / 3,5mm / 170mm

NHS-1727  
Ø 4,5mm / 5,5mm / 170mm

NHS-1728  
Ø 3,5mm / 4,5mm / 170mm

NHS-1729  
Ø 6,0mm / 7,0mm / 170mm



NHS-1730  
18cm  
Straight / Bend  
I.D 2.5mm  
O.D 3.5

NHS-1731  
18cm  
Straight / Bend  
I.D 3.5mm  
O.D 4.5

NHS-1732  
18cm  
Straight / Bend  
I.D 4.5mm  
O.D 5.5

NHS-1733  
18cm  
Straight / Bend  
I.D 6.0mm  
O.D 7.0



NHS-1734  
17.5cm

NHS-1735  
18cm

NHS-1736  
coarse  
Ø 5mm

Suction tubes to collect the extracted bone material 180mm

BSI-1737  
fine  
Ø 9mm



NHS-1738  
Suction Tubes  
180mm

NHS-1739  
Suction Tubes  
180mm

NHS-1740  
Suction Tubes  
180mm



NHS-1742  
Ø 3 mm  
length 180mm

NHS-1743  
Ø 4 mm  
length 180mm

NHS-1744  
Ø 5 mm  
length 180mm

NHS-1741  
Fig. 6FR  
Frazier  
15 cm - Ø 2 mm



# IMPRESSION TRAYS

- Оттисные ложки
  - Porte-empreinte
  - Abdrucklöffel
- Відбиткові ложки
  - Cubetas para impresiones
  - صواني الاطباع

**PERFORATED WITH RIM LOCK**  
Set of 06 Pcs

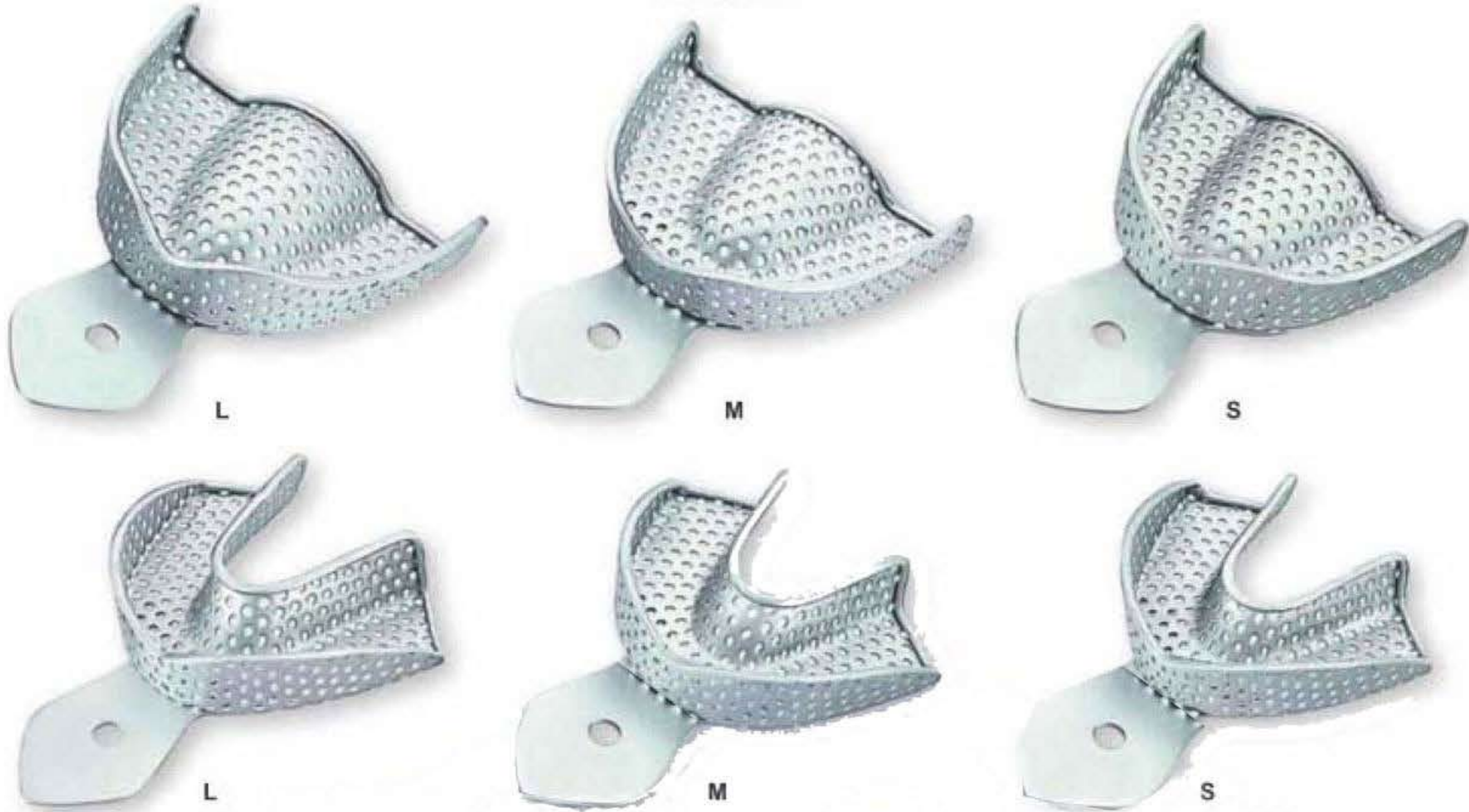

**NHS-1745 SET OF 06 PCS**  
Upper: S, M, L  
Lower: S, M, L

**PERFORATED WITH RIM LOCK**  
Set of 8 Pcs



**NHS-1746 SET OF 08 PCS**  
Upper: XS, S, M, L  
Lower: XS, S, M, L

**NHS-1747 SET OF 08 PCS**  
Upper: S, M, L, XL  
Lower: S, M, L, XL

**NHS-1748 SET OF 10 PCS**  
Upper: XS, S, M, L, XL  
Lower: XS, S, M, L, XL







## IMPRESSION TRAYS

- Оттисные ложки
  - Porte-empreinte
  - Abdrucklöffel
- Відбиткові ложки
  - Cubetas para impresiones
  - صواني الانطباع

**SOLID WITH RIM LOCK**  
Set of 6 Pcs



L



M



S



L



M



S

**NHS-1749 SET OF 06 PCS**  
Upper: S, M, L  
Lower: S, M, L

**SOLID WITH RIM LOCK**  
Set of 8 Pcs



L



M



S



XS



L



M



S



XS

**NHS-1750 SET OF 08 PCS**  
Upper: XS, S, M, L  
Lower: XS, S, M, L

**NHS-1751 SET OF 08 PCS**  
Upper: S, M, L, XL  
Lower: S, M, L, XL

**NHS-1752 SET OF 10 PCS**  
Upper: XS, S, M, L, XL  
Lower: XS, S, M, L, XL







# IMPRESSION TRAYS

- Оттисные ложки
- Porte-empreinte
- Abdrucklöffel
- Відбиткові ложки
- Cubetas para impresiones
- صواني الاطباع

## PERFORATED FULL DENTURE

Set of 8 Pcs

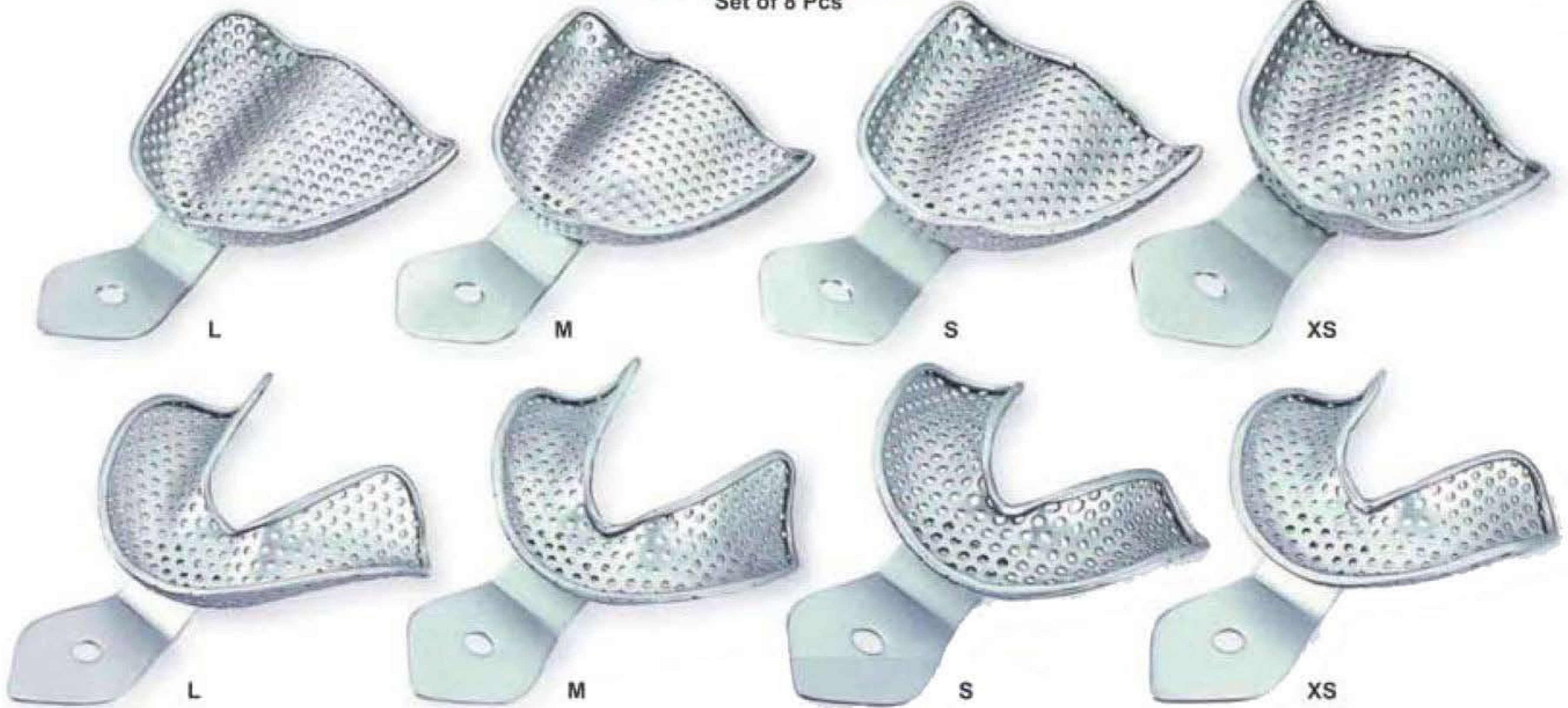

NHS-1753 SET OF 08 PCS  
Upper: S, M, L, XL  
Lower: S, M, L, XL

NHS-1754 SET OF 08 PCS  
Upper: S, M, L  
Lower: S, M, L

## SOLID FULL DENTURE

Set of 8 Pcs

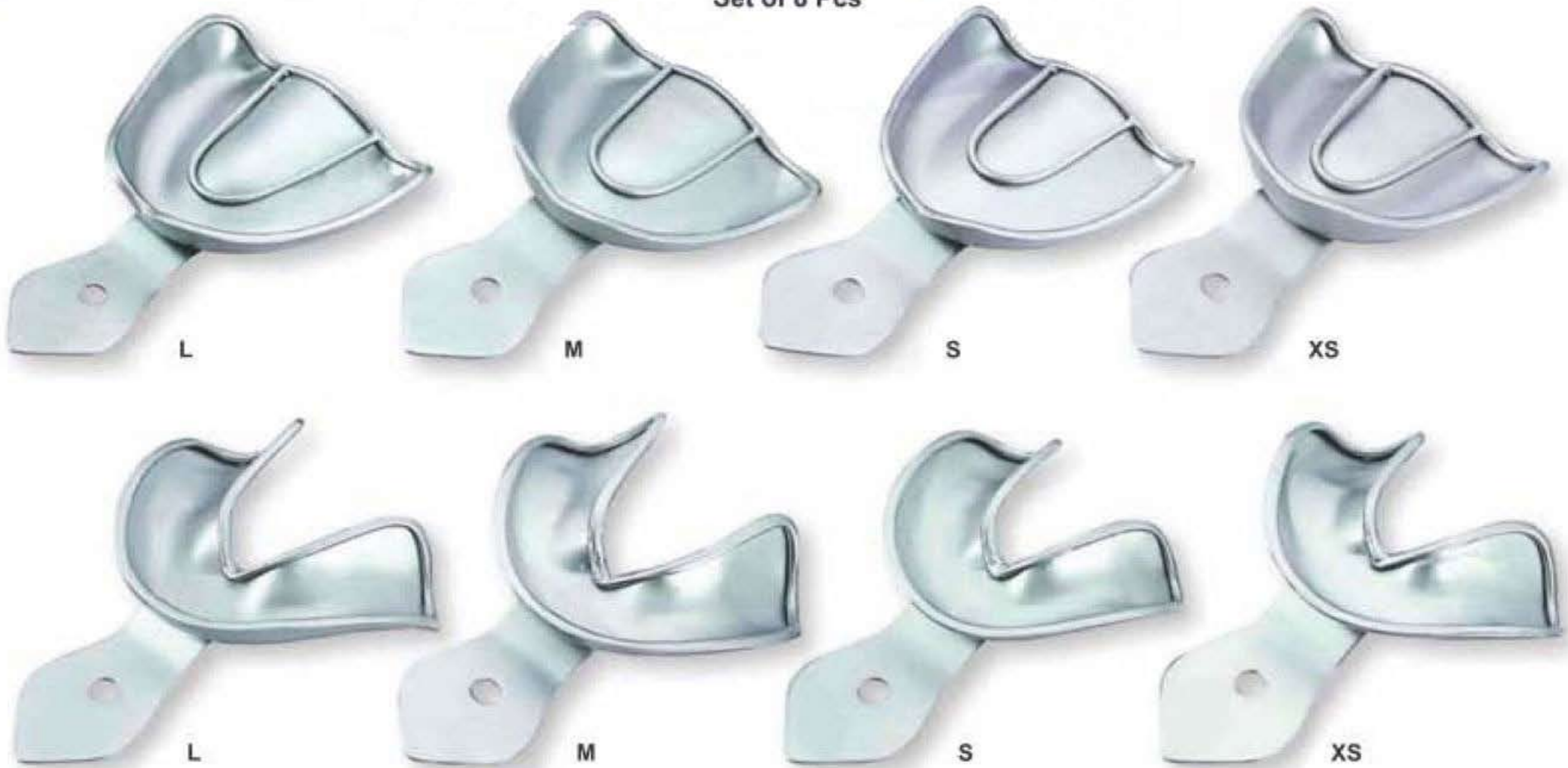

NHS-1755 SET OF 08 PCS  
Upper: S, M, L, XL  
Lower: S, M, L, XL

NHS-1756 SET OF 06 PCS  
Upper: S, M, L  
Lower: S, M, L







- Оттисные ложки
- Porte-empreinte
- Abdrucklöffel
- Відбиткові ложки
- Cubetas para impresiones
- صواني الانطباع

### Perforated Without Rim Lock

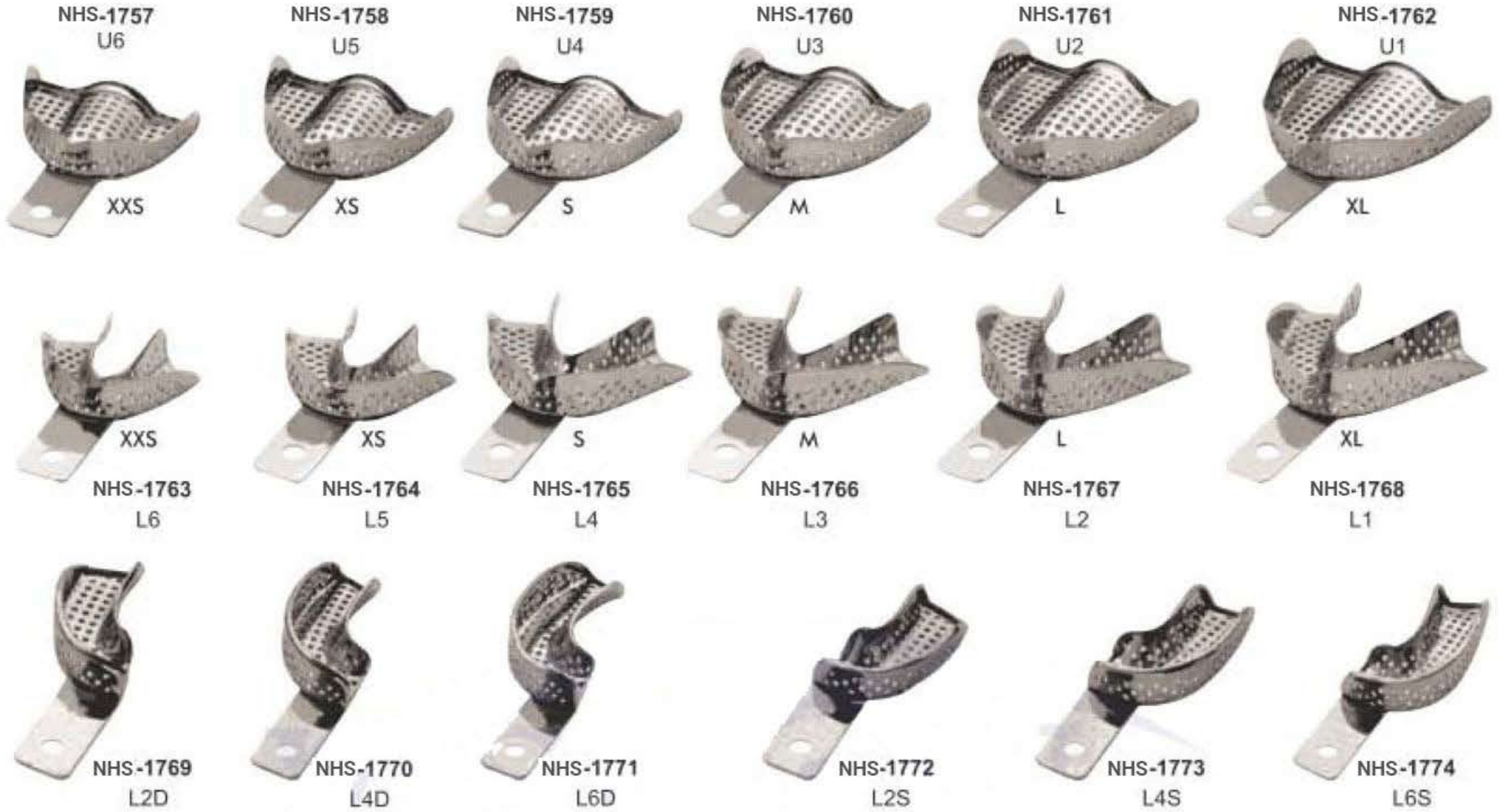

### Solid With Rim Lock

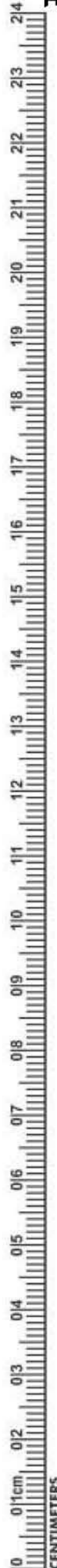
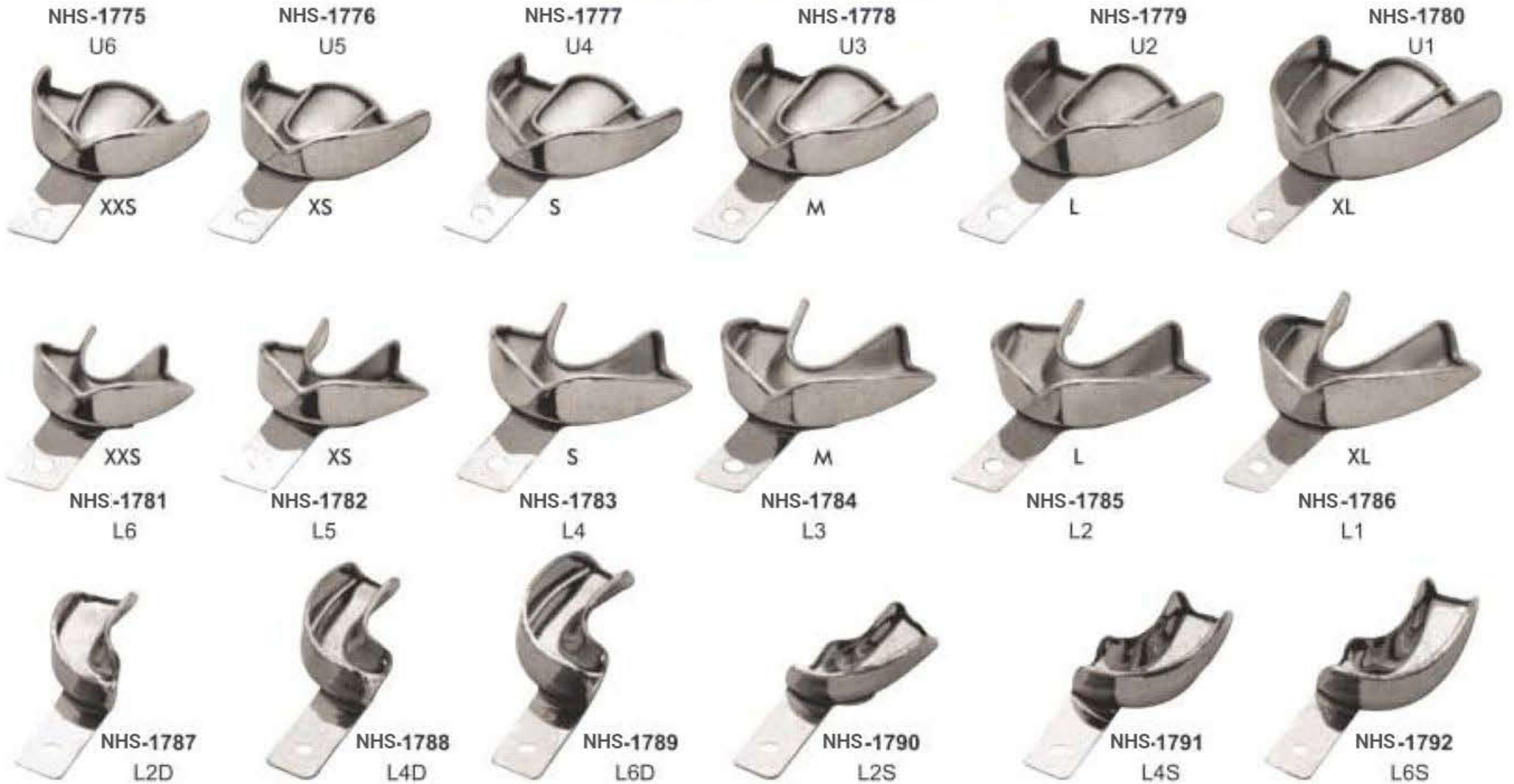



# INSTRUMENTS CASSETTES & STANDS



**NHS-1793**  
Instruments Cassettes  
5 Pieces, 7 Pieces, 10 Pieces & 20 Pieces



**NHS-1794**  
Instruments Cassettes  
5 Pieces, 7 Pieces, 10 Pieces & 20 Pieces

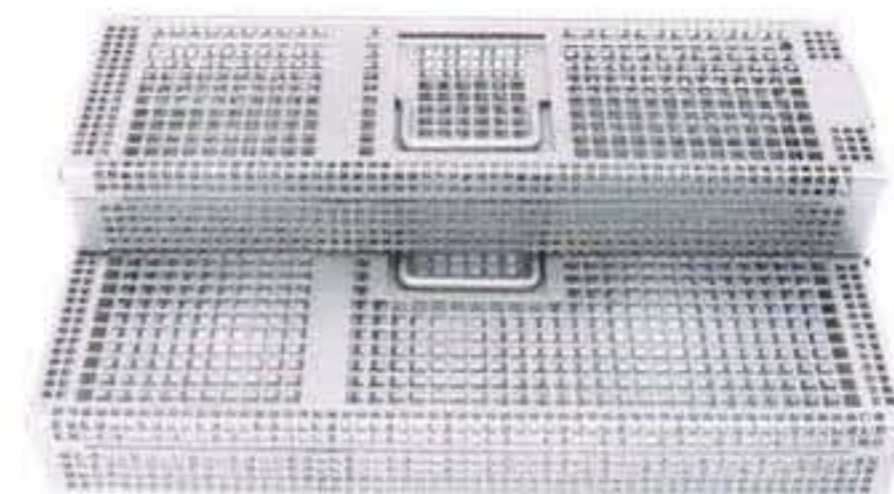

**NHS-1795**  
Instruments Cassette  
7 Pieces & 10 Pieces



**NHS-1796**  
Gracey Curette Set Cassettes



**NHS-1797**  
182 x 150 x 20 mm  
10 Instruments



**NHS-1798**  
180 x 85 x 15 mm  
5 Instruments



**NHS-1799**  
288 x 182 x 35 mm  
20 Instruments



**NHS-1800**  
288 x 182 x 35 mm  
20 Instruments



**NHS-1801**  
182 x 145 x 35 mm  
10 Instruments



**NHS-1802**  
182 x 72 x 35 mm  
5 Instruments

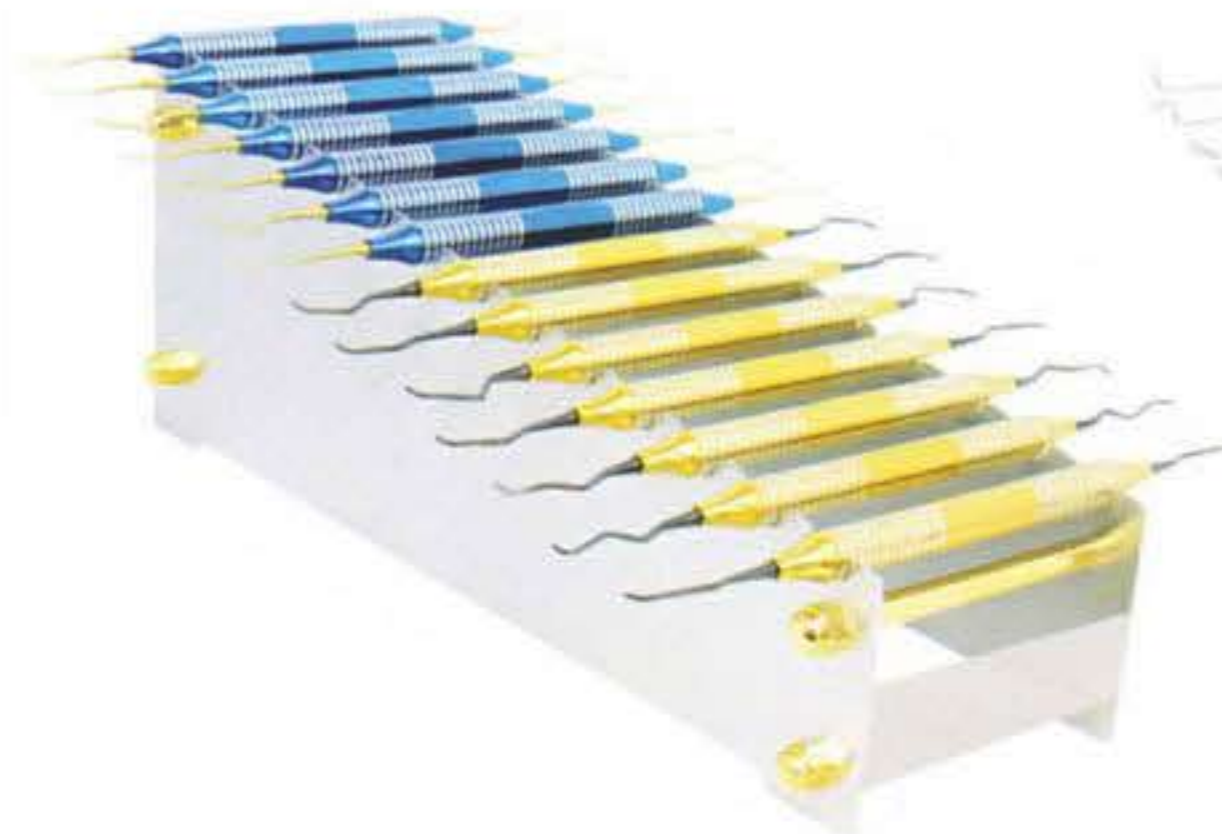

**NHS-1804**  
Gracey Curette Set Stand

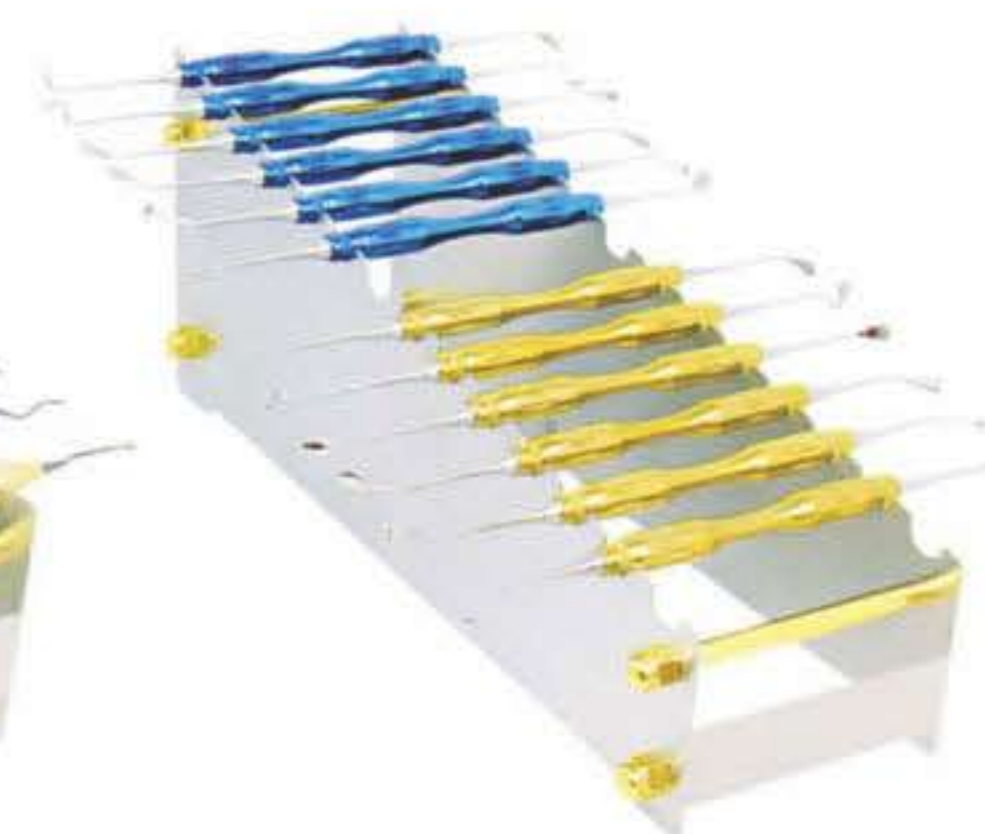

**NHS-1805**  
Sinus Lift Set Stand



**NHS-1803**  
182 x 145 x 35 mm  
9 Instruments







Made of 18/8 stainless steel



**KIDNEY TRAY WITH COVER**  
(English Pattern)

	Size
NHS-1806	150 mm
NHS-1807	200 mm
NHS-1808	240 mm
NHS-1809	300 mm



**Kidney Trays**

	With lid available	Without lid available
NHS-1810	6"	NHS-1814 6"
NHS-1811	8"	NHS-1815 8"
NHS-1812	10"	NHS-1816 10"
NHS-1813	12"	NHS-1817 12"



Deep	
NHS-1818	2.25" - 2"
NHS-1819	4.75" - 2"
NHS-1820	5.5" - 2.5"
NHS-1821	6.25" - 2.75"
NHS-1822	7" - 3.5"



**Sterilizing Drum**

Art #	∅ mm	h mm
NHS-1823	80	80
NHS-1824	120	120
NHS-1825	160	120
NHS-1826	190	140
NHS-1827	190	200
NHS-1828	240	120
NHS-1829	240	160
NHS-1830	240	240
NHS-1831	290	120
NHS-1832	290	160
NHS-1833	290	240
NHS-1834	340	160
NHS-1835	340	240
NHS-1836	390	145
NHS-1837	390	200
NHS-1838	390	290



**Cotton Holder - NHS-1839**



**Spirit Lamp NHS-1840**



**NHS-1841 Endodontic Box**



Forcep Jar	
NHS-1842	25 x 80mm
NHS-1843	30 x 100mm
NHS-1844	100 x 200mm
NHS-1845	75 x 173mm



NHS-1846 6" x 8"  
NHS-1847 8" x 10"  
NHS-1848 10" x 12"  
Without Lid



**NHS-1849 Instruments Box**



**SCALER TRAY NHS-1850**  
100 x 200 mm

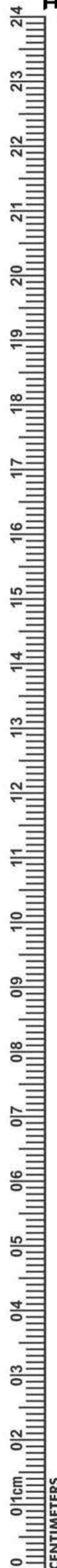

CENTIMETERS



DESCRIPTION	PAGE #	DESCRIPTION	PAGE #	DESCRIPTION	PAGE #
3 PRONG CLASP ADJUSTABLE PLIER TC	107	CARVERS FILLING INSTRUMENTS	69	FLAT NOSE PLIER WITH SERRATION	105
ACORN FILLING INSTRUMENTS	52	CARVERS INSTRUMENTS	73	FLOHR ROOT ELEVATORS	20
ADAM PLIER WITH TC	102	CARVERS	71	FLUCH-CUT DISTAL AND CUTTING PLIERS	100
ADAMS PLIER ROUND BOX	100	CASTROVIEJO NEEDLE HOLDERS	86	FOERSTER DRESSING FORCEPS	148
ADAMS PLIERS FOR BENDING WIRE	100	CASTROVIEJO SCISSORS	84	FORCEP JAR	148
ADAMS, SMALL WIRE BENDING AND LOOP FORMING PLIERS	99	CEMENT SPATULAS	75	FREEDMAN "DUCKHEAD" IMPLANTOLOGY INSTRUMENTS	112
ADERER FACEBOW LOOP FORMING PLIERS	101	CHEEK RETRACTOR LONG	80	FREEDMAN BURNISHERS IMPLANTOLOGY INSTRUMENTS	112
ADERER LARGE WIRE BENDING AND LOOP FORMING PLIERS	100	CHEEK RETRACTOR	78	FREER PERIOSTEEL ELEVATORS	95
ADERER PLIER	101	CHEEK RETRACTORS, MINNESOTA	80	FRIEDMAN BONE ROUNGER	14
ADSON BROWN TWEEZERS	32	CHEEK RETRACTORS, RETRACTOR IVORY	80	FRIEDMANN ROOTS ELEVATOR	21
ADSON CARBIDE TIPPED TISSUE FORCEPS	133	CHEEK RETRACTORS, TONGUE DEPRESSORS	80	GAUGE FOR MEASURING	109
ADSON NEEDLE HOLDERS	86	CHISELS HOES FILLING INSTRUMENTS	74	GERALD TWEEZERS	31
ADSON TWEEZERS	32	CLAMP, OSTEO METER	109	GILLES TWEEZERS	31
ADSON-TC TWEEZERS	32	CLAPPISON/FRAHAM RESTORATIVE INSTRUMENTS	70	GILLIES NEEDLE HOLDER WITH SCISSORS	36
ALLEN PERIOSTEEL ELEVATORS	95	CLAW-LIFT ROOTS ELEVATOR	22	GOLDMAN FOX EXPLORERS	36
ALLIS 4:5 HAEMOSTATIC FORCEPS	87	COHEN UNIVERSAL FORCEPS	10-11	GOLDMAN FOX MERRIT B EXPLORERS	36
ALLIS-BABY 3:4 HAEMOSTATIC FORCEPS	87	COLLEGE CURVED	32	GOLDMAN FOX UNIVERSITY OF MICHIGAN EXPLORERS	36
AMALGAM CARVERS	56-57, 70-71	COLLEGE TWEEZER	32	GOLDMAN FOX WILLIAMS EXPLORERS	36
AMALGAM FILES	71	COLLEGE WITH LOCK TWEEZERS	31	GOLDMAN PERIODONTAL INSTRUMENTS	58
AMALGAM INSTRUMENTS & SCALPEL HANDLES	92	COLLINS TONGUE FORCEPS	31	GOLDMAN-FOX PERIOSTEEL ELEVATORS	95
AMALGAM INSTRUMENTS	93	COMPOSITE/PLASTIC FILLING INSTRUMENTS	49-50, 54	GOLDMAN-FOX SCISSORS	83-84
AMALGAM WELL MATRIX RETAINERS	91	CONDENSER INSTRUMENTS	118	GOLDMAN-FOX SET	61
AMALGAM WELL	93	CONDENSER MORTONSON FILLING INSTRUMENTS	50	GOLDSTEIN INTERPROXIMAL EXCAVATOR	67
ANATOMICAL CARVER	71	CONTOURING INSTRUMENT IMPLANTOLOGY INSTRUMENTS	111	GRACEY AFTER FIVE	42
ANDREW RESTORATIVE INSTRUMENTS	70	CONTOURING PLIER	101	GRACEY CURETTE INSTRUMENTS	62
ANGLE FORMERS	72	COSMETIC CONTOURING	113	GRACEY CURETTE SET CASSETTES	147
ANGLED DIRECT BOND BRACKET REMOVER TC	106	COTTON HOLDER	148	GRACEY CURETTE	43
ANISWORTH CLAMPS FORCEPS	88	COUPLAND ROOT ELEVATORS	17	GRACEY MINI FIVE	42
ANTERIOR FILLING INSTRUMENTS	68	COUPLAND ROOT ELEVATORS	18	GRACEY PERIODONTAL INSTRUMENTS	39
ANTERIOR	47	CRANE KAPLAN TWEEZERS	32	GRACEY SET OF 7 PCS	40-41
APEXO ROOT ELEVATORS	15-19	CRANE-KAPLAN PERIODONTAL INSTRUMENTS	59	GRAFT PACKER, CONCAVE TIPS	125
APICAL ROOT ELEVATORS	19	CRILE NEEDLE HOLDERS	85	GREGG IMPLANTOLOGY INSTRUMENTS	111
ARCH FORMING PLIERS	104	CRILE-WOOD NEEDLE HOLDERS	85-86	GRITMAN CEMENT SPATULAS	75
ARTICULATORS	77	CROWN AND BAND CONTOURING PLIERS	105	GROSS MAIER DRESSING FORCEPS	107
A-TRAUMATIC EXTRACTION SET	03	CROWN REMOVER	90	GUM SCISSORS	107
ATRAUMATIC TWEEZERS	31	CROWN SPREADERS	90	HAEMOSTATIC FORCEPS & TOWEL CLAMPS	87
BACK ACTION FILLING INSTRUMENTS	52	CRYER EXTRACTING FORCEPS	10	HALSEY NEEDLE HOLDERS	85-86
BACKHAUS HAEMOSTATIC FORCEPS	87	CRYER ROOTS ELEVATOR	23	HALSTEAD MOSQUITO HAEMOSTATIC FORCEPS	87
BACOLITE HANDLE WAX KNIVES	76	CURETTE COLUMBIA	43	HALSTEAD MOSQUITO NEEDLE HOLDERS	86
BALDWIN FILLING INSTRUMENTS	49	CURETTE INSTRUMENTS	63	HALTEPINZETTE WITH LOCK	134
BALL FILLING INSTRUMENTS	52	CURETTE MCCALL	43	HAMMER HEAD TIE BACK PLIER	104
BALL HOOK CRIMPING PLIER	105	CURETTE	60	HANDLES FOR MOUTH MIRRORS	30
BAND PUSHER	90	CURETTES SET OF 8 PIECES	43	HARD WIRE CUTTERS	107
BAND REMOVING PLIER	99	CURETTES	40-43, 61-62	HARRIS EXTRACTING FORCEPS	11
BAND SEATER AUTO CLEAVABLE	97	CUTTING INS PERIODONTAL INSTRUMENTS	39	HARTMANN (BABY MOSQUITO) NEEDLE HOLDERS	86
BAND SEATING PLIER	104	DARBY-PERRY EXCAVATORS	65	HATCHETS FILLING INSTRUMENTS	68
BANDS & CROWNS PLIERS	101	DE LA ROSA PLIERS WITH GROOVED	105	HEAT CARRIERS	46
BASINS FOR BONE	138	DE LA ROSA PLIERS	105	HEBER ROOTS ELEVATOR	24
BAUMGARTER NEEDLE HOLDERS	85	DEAN SCISSORS	84	HEIDBRINK ROOT ELEVATORS	20-21, 26
BAUMGARTNER NEEDLE HOLDERS	86	DEBAKEY ATRAUMATIC TISSUE FORCEPS	133	HEIDMANN PERIODONTAL INSTRUMENTS	39
BAYONET ROOTS ELEVATOR SET	21	DEEP BOWL	148	HEMINGWAY CURETTE INSTRUMENTS	63
BEAVERTAIL FILLING INSTRUMENTS	52	DEEP ROOT PICK FORCEPS (APICAL SET OF 9)	04	HEMINGWAY TWEEZERS	32
BEEBEE NEEDLE HOLDERS	85	DELICATE NEEDLE HOLDERS	85	HOES	71
BEIN ROOT ELEVATORS	15-16, 24	DELUXE BRACKET HOLDER TWEEZERS	96	HOLLANBACK PERIODONTAL INSTRUMENTS	39
BEYER BONE ROUNGER	14	DENHARD CHEEK RETRACTORS	79	HOLLENBACK FILLING INSTRUMENTS	50
BINANGLE FILLING INSTRUMENTS	74	DENTAL MIRROR PERIODONTAL INSTRUMENTS	39	HOLLENBACK IMPLANTOLOGY INSTRUMENTS	114
BIRD BEAK ANGLED BENDING PLIER	103	DENTAL SYRINGES	13	HOLLENBACK RESTORATIVE INSTRUMENTS	70
BIRD BEAK PLIER WITH TC	102	DERF NEEDLE HOLDERS	85	HOLLOW HANDLE	132
BIRD BEAK WIRE BENDING & CUTTING PLIERS	101	DERF NEEDLE HOLDERS	86	HOLLOW WARE	148
BIRD BEAK WIRE BENDING PLIER	100	DIRECT BOND BRACKET HOLDER TWEEZERS	96	HOLLOWCHOP CONTOURING PLIERS	106
BIRD BEAK WITH CUTTER PLIERS	104	DIRECT BONDING BRACKET HOLDERS	96	HOOK CRIMPING PLIER ANGLED STRAIGHT TC	107
BLACK FILLING INSTRUMENTS	50	DIRECT BONDING BRACKET REMOVER PLIER TC	106	HOOK KNIVES	76
BLACK TITANIUM COLOUR COATED INSTRUMENTS	110-111	DIRECT BRACKET REMOVER TC	107	HOW PLIER CURVED WITH TC	103
BLADE AND PUSHER	126	DISCOID-CLEOID CARVER	71	HOW PLIER CURVED	99, 104
BLUMENTHAL BONE ROUNGER	14	DISTAL END CUTTER REGULAR WITH T.C	102	HOW PLIER STRAIGHT WITH TC	103
BOGHOSIAN FILLING INSTRUMENTS	49	DISTAL END CUTTER, SAFETY HOLD PLIER	107	HOW PLIER STRAIGHT	103
BOGHOSIAN IMPLANTOLOGY INSTRUMENTS	111	(IDEAL FOR CUTTING WIRE) TC	107	HOWARD PERIOSTEEL ELEVATORS	95
BOLEY GAUGE	109	DISTAL END, WIRE CUTTERS & BRACKET REMOVER PLIERS	107	HYGIENIST PERIODONTAL INSTRUMENTS	58
BONE BRACKET GAUGE	96	DOUBLE ENDED CEMENT SPATULA	98	HYGIENIST-JACQUETTE PERIODONTAL INSTRUMENTS	58
BONE CARRIER TITANIUM	124	DRESSING TWEEZERS	31-32	HYGIENIST-TOWNER PERIODONTAL INSTRUMENTS	58
BONE CRUSHER	138, 140	ELASTIC SEPARATING PLIER	107	HYLIN CEMENT SPATULAS	75
BONE EXPANDER SCREW & SURGICAL KITS	141	ELASTOMERIC LIGATURE PLACING FORCEPS	107	HYLIN ROOTS ELEVATOR	23
BONE FILES	94	WITH GROOVE FALCON	107	IMPLANT GAGES	108
BONE GRAFT/CARRIER TITANIUM	128	ELLIOT MATRIX RETAINERS	91	IMPLANT SINUS LIFT INSTRUMENTS	117, 122
BONE GRAFTING INSTRUMENTS COMPACTOR /TAMPERS	125	ENDED CHEEK RETRACTORS	79	IMPLANT	123
BONE GRAFTING INSTRUMENTS	126-127	ENDODONTIC BOX	148	IMPLANTOLOGY IMPLANTOLOGY INSTRUMENTS	112
BONE INJECTORS, COLLECTORS & SUCTION TUBE	142	ENDODONTICS INSTRUMENTS	47	IMPLANTOLOGY INSTRUMENTS	111
BONE MILL	138	ENGLISH PATTERN KLEIN #3 PEDODONTIC UNIVERSAL FORCEPS	08	IMPLANTOLOGY	108-110
BONE ROUNGER	14	EXAMINATION KIT SET OF 3 PIECES	34	IMPRESSION TRAYS	143-146
BONE SCRAPER STRAIGHT & CURVED	138	EXAMINATION SET OF 4 PIECES	34	INSTRUMENTS BOX	148
BONE SPOON/ PACKER	125	EXAVATORS	37	INSTRUMENTS CASSETTES & STANDS	147
BONE THICKNESS GAUGE	109	EXCAVATOR PERIODONTAL INSTRUMENTS	39	INTERPROXIMAL CARVER IMPLANTOLOGY INSTRUMENTS	111
BONE UNIVERSAL KIT	141	EXCAVATORS INSTRUMENTS SET OF 11 PIECES	57	INTERPROXIMAL OFF-ANGLE FILLING INSTRUMENTS	49
BRACKET REMOVER ANGULATED PLIER	103	EXCAVATORS INSTRUMENTS	64-67	INTRALIGAMENTAL ANESTHESIA SYRINGE	13
BRACKET REMOVER PLIER STRAIGHT	103	EXCAVATORS	64	IRIS SCISSORS	83-84
BRACKET REMOVER PLIERS ANGLED WITH T.C	102	EXPLORER PERIODONTAL INSTRUMENTS	39	IVORY LIGHT WEIGHT CLAMPS FORCEPS	88
BRACKET REMOVER PLIERS STRAIGHT WITH T.C	102	EXPLORERS INSTRUMENTS	35	IVORY MATRIX RETAINERS	91
BRACKET REMOVING PLIER ROUND BOX	99	EXPLORERS	33-45	IWANSON SPRING CALIPER	109
BRACKET REMOVING PLIER	99	EXTRACTING FORCEPS (AMERICAN PATTERN)	10-14	JACQUETTE SCALERS PERIODONTAL INSTRUMENTS	59
BREWER CLAMPS FORCEPS	88	EXTRACTING FORCEPS (ENGLISH PATTERN)	01-02, 05-07	JARA BEAK PLIER	104
BURNISHER FILLING INSTRUMENTS	49	EXTRA-FLEX IMPLANTOLOGY INSTRUMENTS	114	JENNINGS CHEEK RETRACTORS	79
BURNISHER FILLING INSTRUMENTS	54	FALCON BEAK CONTOURING PLIERS	100	JOHNSON CONTOURING PLIERS	100
BURNISHER UNIVERSITY OF MICHIGAN AMALGAM CARVERS	56	FARABEUF RETRACTOR	82	JONES HAEMOSTATIC FORCEPS	87
BURNISHERS FILLING INSTRUMENTS	52-53	FELDMAN RETRACTOR	82	JOSEPH SCISSORS	84
BURNISHERS IMPLANTOLOGY INSTRUMENTS	112	FILES FILLING INSTRUMENTS	53	KELLY HAEMOSTATIC FORCEPS	87
BUSER PERIOSTEEL ELEVATORS	95	FILLING INS PERIODONTAL INSTRUMENTS	39	KELLY SCISSORS	83-84
CARRY FORCEPS	134	FILLING INSTRUMENTS	37, 44, 49-55, 69, 72	KELLY-RANKIN HAEMOSTATIC FORCEPS	87
CARVER HOLLENBACK AMALGAM CARVERS	56	FLAT NOSE PLIER SMOOTH	105	KEYS FOR IMPLANT SCREW	139





DESCRIPTION	PAGE #	DESCRIPTION	PAGE #	DESCRIPTION	PAGE #
KIDNEY TRAY WITH COVER (ENGLISH PATTERN)	148	ORTHO LIGHT SCALER HEAVY	97	SINUS LIFT INSTRUMENT	118-121
KIDNEY TRAYS	148	ORTHO LIGHT SCALER SINGLE ENDED	98	SINUS LIFT SET STAND	147
KILNER (RAGNELL) SCISSORS	84	ORTHO LIGHT SCALER	97	SINUS WINDOW BONE TAMPERS	127
KLEINERT-KUTZ BONE ROUNDING	14	ORTHODONTIC INSTRUMENTS	96-98	SINUSLIFT INSTRUMENTS	118
KOPP ROOTS ELEVATOR	23-24	ORTHOLITE LIGATURE DIRECTOR SCALER	98	SIQVELAND RETAINERS TOFFLEMIRE-JUNIER MATRIX RETAINERS	91
KRARNER-NEVINS BONE CHISEL	94	OSTEOMETER MEASURING FORCEPS	96	SMAHA ELASTOMERIC LIGATURE PLACING FORCEPS	107
LA GRANGE SCISSORS	83-84	OSTEOTOME CONVEXES / CONCAVE / CONIQUES	135-136	SPENCER SCISSORS	84
LADMORE FILLING INSTRUMENTS	52	OVAL SPOONS/DARBY-PERRY	65	SPIRIT LAMP	148
LADMORE IMPLANTOLOGY INSTRUMENTS	112	P.K. THOMAS WAXING INSTRUMENTS	73	SPOON AND PUSHER (TRINOVO)	128
LAP-JOINT THREE PRONG PLIER	106	PALATAL ARCH PLIER	105	SPOON AND PUSHER WITH SAFETY STOP	128
LAXUTOR ROOT ELEVATORS	19	PALMER CLAMPS FORCEPZ	88	SPOONS	64
LE CRON CEMENT SPATULAS	75	PDL ELEVATORS	28-29	SPREADERS	46
LESSMANN	76	PEDIATRIC TOOTH EXTRACTING FORCEPS SET	09	STANDARD LIGATURE CUTTER TC	106
LIGATURE FORMING PLIERS	101	PERIODONTAL FILLING INSTRUMENTS	53	STEP PLIERS WITH T.C	103
LIGHT WIRE BIRD BEAK LONG PLIER WITH TC	102	PERIODONTAL INSTRUMENTS	37, 39, 58, 60, 95	STERILIZING DRUM	148
LIGHT WIRE BIRD BEAK LONG PLIER	104	PERIODONTAL PROBES	46, 48	STOP V BENDING PLIER	105
LIGHT WIRE BIRD BEAK PLIERS	104	PERIOSTEALS ELEVATOR	95, 129-130	STRAIGHT DIRECT BOND BRACKET REMOVER TC	107
LIGHT WIRE CUTTER MICRO WITH T.C	102	PERIOTOME ROOTS ELEVATOR	26	SURGICAL CHISELS	123
LIGHT WIRE PLIER	104	PERRY TWEEZER	31-32	SURGICAL TWEEZERS	31
LINDO LEVIAN ROOT ELEVATORS	20	PESTERIOR BEND REMOVER PLIER LONG	103	SUTURE PLIERS SUTURE FORCEPS	133
LINGUAL / PALATAL ARCH FORMING PLIERS	101	PESTERIOR BEND REMOVER PLIER MEDIUM	103	SYNDESMOTOMES ROOTS ELEVATOR	26
LINGUAL PLIER LONG HANDLE	106	PESTERIOR BEND REMOVER PLIER SHORT	103	TAMPER	126
LINGUAL PLIER WEINGART	106	PIN & LIGATURE CUTTERS TC	106	TANNER FILLING INSTRUMENTS	52, 69
LINGUAL WEINGART PLIER	106	PIN HOLDING PLIER TC	107	TANNER IMPLANTOLOGY INSTRUMENTS	114
LINING APPLICATOR DOUBLE END	55	PIN-TWEEZERS	134	TC GRIPPER CARBIDE	133
LOCKLIN SCISSORS	84	PLAIN MIRRORS	30	THARP RESTORATIVE INSTRUMENTS	70
LONDON COLLEGE TWEEZERS	31	PLASTER KNIFE 76 SPECIAL INOX	76	THREE PRONG PLIERS REGULAR	106
LORNA HAEMOSTATIC FORCEPS	87	PLIERS FOR ORTHODONTICS & PROSTHETICS	99-106	TISSUE GRAFT FORCEP SERRATED TEETH	133
LUCAS	132	PLUGER PERIODONTAL INSTRUMENTS	39	TISSUE MEMBRANE FORCEPS	132, 134
LUER BONE ROUNDING	14	PLUGGER BLACK AMALGAM CARVERS	56	TISSUE PUNCH FORCEPS	134
LUKS	47	PLUGGERS	45, 48	TISSUE PUNCH STRAIGHT & CURVED	138
LUXATOR ROOT ELEVATORS	15-16, 21	PLUGGERS/CONDENSERS FILLING INSTRUMENTS	50	TOFFLEMIRE-SENIOR MATRIX RETAINERS	91
LUXIER ROOTS ELEVATOR	22	PLUGGERS/CONDENSERS	51	TOFFLEMIRE-UNIVERSAL MATRIX RETAINERS	91
MAGNIFYING MIRRORS	30	POINTED CURETTE	60	TORQUE WRENCH & RATCHET	139
MANUAL CROWN REMOVER	90	POINTED PROBES SINGLE ENDED	36	TOWNER PERIODONTAL INSTRUMENTS	58
MARCOTTE LOOPING PLIER	105	POSTERIOR	48	TOWNER-JACQUETTE PERIODONTAL INSTRUMENTS	58
MARGIN TRIMMERS	72	POSTERIOR BAND REMOVER PLIERS	102	TREPINE DRILL SET OF EIGHT PIECES	137
MARGINAL RIDGE & EMBRASURE SHAPING INSTRUMENT	113	POTT ROOTS ELEVATOR	25	TUFTS FILLING INSTRUMENTS	49
MARKLEY PLUGGERS/CONDENSERS	51	POWER CROWN REMOVER LIFT	90	TUNNELIERUNGS INSTRUMENT	126
MARQUETTE FILLING INSTRUMENTS	50	PRICHARD PERIOSTEAL ELEVATORS	95	TWEED / ANGEL FORMING AND TORQUING PLIERS	101
MARYAM TWEEZERS	32	PROBES DOUBLE ENDED	35	TWEED / ANGLE RECTANGULAR ARCH FORMING & TORQUING PLIERS	100
MATHIEU NEEDLE HOLDERS	86	PROBES SINGLE ENDED	34	TWEED ARCH FORMING PLIER TC	102
MATRIX RETAINERS	91	QUÉTIN FILLING INSTRUMENTS	49	TWEED CUTTER PLIER	104
MAYO NEEDLE HOLDERS	85	RASPATOR, BENQUE	131	TWEED LOOP FORMING PLIERS	100
MAYO SCISSORS	83	RASPATOR, FREER	129, 131	TWEED LOOP FORMING PLIER TC	105
MAYO-HEGAR NEEDLE HOLDERS	85-86	RASPATOR, MICRO FREER	131	TWEED LOOP FORMING PLIERS	99
MEAD 1A BONE ROUNDING	14	RASPATOR, MICRO RASPATOR / CHISEL	131	TWEED LOOP PLIER	104-105
MEAD BONE FILES	94	RASPATOR, MICRO-FREER	129	TWEEZER PERIODONTAL INSTRUMENTS	39
MEASURING LOOP	109	RASPATOR, NORDBERG	131	TWEEZERS	31
MEASURING LOOP, CASTROVIEJO	109	RASPATOR, PRICHARD	124	TWEEZERS	32
MEDIUM CEMENT CEMENT SPATULAS	75	RASPATOR, RASPATORY PERIOSTEAL ELEVATORS	95	TWEL-ON ELASTIC MODULE INSTRUMENT	97
MEDIUM PLACING/CONDENSING IMPLANTOLOGY INSTRUMENTS	114	RASPATOR, WAUTIER	131	UNIVERSAL DOLPHIN STYLE WIRE BENDING & CUTTING PLIERS	99
MEMBRANE POSITIONING INSTRUMENTS	118	RASPATOR, WILLIGER PERIOSTEAL ELEVATORS	95	UNIVERSAL FILLING INSTRUMENTS	49
MEMBRANE TWEEZERS KUEHNE	134	RASPATORY CHIPPING	131	UNIVERSAL FILLING INSTRUMENTS	54
MERIAM TWEEZERS	31	RASPATORY MICRO MOLT	131	UNIVERSAL NEEDLE HOLDERS	85
MERRIT A EXPLORERS	36	RASPATORY MOLT	131	UNIVERSITY OF MICHIGAN EXPLORERS	36
MERRIT B EXPLORERS	36	REGULAR TWEED ARCH FORMING PLIERS	104	UTILITY PLIER WEINGART TC	107
MERSON CROWN REMOVER	90	RESTORATIVE INSTRUMENTS	51-53, 68, 70-72	V BEND ROOT PLIER TC	106
METZENBAUM NEEDLE HOLDERS	85	RETRACTOR WITH ERGO GRIP	90	W. BARRY ROOTS ELEVATOR	25
METZENBAUM SCISSORS	83	RETRACTORS - MOUTH GAGS	78-79	WAHL BONE FILES	94
MICOR ADSON TISSUE FORCEP	133	RETRACTORS	80-82	WALDSAVHS WIRE BENDING AND CUTTING PLIERS	101
MICRO IRIS SCISSORS	83	RETRACTORS CHEEK RETRACTOR COMBINATION COMBINATION	80	WALL FILLING INSTRUMENTS	69
MICRO-FRIEDMAN BONE ROUNDING	14	RETRACTORS COMBINATION	81	WANGEN HOLDER	78
MILLER BONE FILES	94	RETRACTORS, LANGENBECK	82	WARD AMALGAM CARVERS	56
MILLER TWEEZERS	32	RETRACTORS, MINI-LANGENBECK	81	WARD FILLING INSTRUMENTS	69
MILLER	132	RETRACTORS, UNIQUE	81	WAX KNIVES	76
MINI LIGATURE CUTTERS	100	RETRO FILLING	48	WEDELSTAEDT	71
MINI PIN & LIGATURE CUTTER TC	106	REVERSED LIGATURE CUTTER ANGLED	102	WEINGART GENERAL UTILITY PLIER LONG MOUTH WITH TC	103
MIXING SPATULA WITH SHOVEL	124	RHODIUM MIRRORS	30	WEINGART PLIER MEDIUM	99-101
MODIED MCCALL	60	ROCHESTER-KOCHER 1X2 HAEMOSTATIC FORCEPS	87	WEINGART PLIER REGULAR WITH TC	103
MOLT BONE FILES	94	ROCHESTER-PEAN HAEMOSTATIC FORCEPS	87	WEINGART PLIER SLIM WITH TC	102
MOLT PERIOSTEAL ELEVATORS	95	ROOT ELEVATOR	15-29	WEINGART PLIER UNIVERSAL WITH TC	103
MORTONSEN FILLING INSTRUMENT	55	ROOT PLANNING FILES	94	WEINGART PLIER UTILITY WITH TC	103
MOUTH GAG MOLT	78	ROOT PLANNING FILES & BONE FILES	94	WEITLANDER CHEEK RETRACTORS	79
MOUTH MIRROR	37	ROOTS ELEVATOR	22	WEITLANDER CHEEK RETRACTORS	79
MSY CEMENT SPATULAS	75	ROSER-KÖNIG CHEEK RETRACTORS	79	WERDELSTAEDT FILLING INSTRUMENTS	74
MULTIFUNCTIONAL METER	108	ROUND NOSE PLIER	104	WESTON CEMENT SPATULAS	75
NAKAWALNL DENTAL LABORATORY INSTRUMENTS	77	ROUNDED CONE	73	WIDE MATRIX RETAINERS	91
NANCE LOOP FORMING PLIERS	99	ROUNDED-CONE FILLING INSTRUMENTS	49	WILLIAM PROBE SET	38
NANCE PLIER	105	RUBBER DAM CLAMPS	89	WILLIAMS EXPLORERS	36
NARROW MATRIX RETAINERS	91	RUBBER DAM CLAMPS FORCEPS	89	WINGURT PLIER SLIM	105
NEEDLE HOLDERS	85-86	RUSSIAN LONG TISSUE FORCEPS	134	WINGURT UTILITY PLIER	105
NEUMANN SCISSORS	84	RUSSIAN TISSUE FORCEPS	134	WINTER ROOTS ELEVATOR	25
NOYES SCISSORS	84	SCALER TRAY	148	WIRE BENDING & LOOP FORMING PLIERS	99
OCCUSAL ANATOMY INSTRUMENT	113	SCALER/CURETTE SETS	60	WISDOM ROOTS ELEVATOR	21
OHL PERIOSTEAL ELEVATORS	95	SCALER/CURETTE SETS INSTRUMENTS	61	WOODEN HANDLE	76
OLSEN-HEGAR NEEDLE HOLDER WITH SCISSORS	51	SCHURE BAND SEATER	97	WOODSON FILLING INSTRUMENTS	49
OREGON PLUGGERS/CONDENSERS	51	SEPARATING ELASTIC PLIER	88	YOUNG PLIER WITH GROOVED	105
ORTHO BAND PUSHER SCALER	98	SELDIN PERIOSTEAL ELEVATORS	95	YOUNG TONGUE FORCEPS	99
ORTHO INSTRUMENT	97	SELDIN RETRACTOR	82	YOUNG WIRE BENDING & LOOP FORMING PLIERS	99
ORTHO LIGATURE DIRECTOR SINGLE ENDED	98	SELDIN ROOT ELEVATORS	15-18, 25	ZAHLE CEMENT SPATULAS	75
ORTHO LIGHT BAND PUSHER SCALER	97-98	SELF LOCKING GROOVED	133		
ORTHO LIGHT DOUBLE ENDED LIGATURE DIRECTOR SCALER	98	SELF-LOCKING TWEEZER	32		
ORTHO LIGHT DOUBLE ENDED LIGATURE DIRECTOR	98	SEMKEN TAYLOR TWEEZERS	31		
ORTHO LIGHT DOUBLE ENDED LIGATURE SCALER	98	SICKLE PERIODONTAL INSTRUMENTS	39		
ORTHO LIGHT DOUBLE ENDED LIGATURE SCALER/DIRECTOR	98	SICKLE SCALERS INSTRUMENTS	58		
ORTHO LIGHT LIGATURE DIRECTOR DOUBLE ENDED	98	SINGLE ENDED PROBE	33		
ORTHO LIGHT SCALER DOUBLE ENDED	97	SINUS LIFT ELEVATOR	115-116		





**NAZEERIYA  
HAROONIYA**  
Surgical Industries

**Inquiry now Today!**

 **WhatsApp: +996708555016**

 **Email: info@nhsurgical.com**

 **Website: www.nhsurgical.com**

**Chowk Duburgi Mallian Madni  
Market Daska Road Sialkot**

[www.nhsurgical.com](http://www.nhsurgical.com)